

MicroDIP, Single-Phase Bridge Rectifiers

1 A

MDB10SS

Features

- Low Package Profile: 1.45 mm (max)
- Requires Only 35 mm² of Board Space
- High Surge Current Capability: 30 A (max)
- Glass Passivated Junction Rectifiers
- Smaller Plastic Body vs MDB10S
- Green Compound
- UL Certification: E352360
- This Device is Pb-Free, Halogen Free/BFR Free and is RoHS Compliant

ABSOLUTE MAXIMUM RATINGS

Symbol	Parameter	Value	Units
V_{RRM}	Maximum Repetitive Peak Reverse Voltage	1000	V
V_{RMS}	Maximum RMS Voltage	700	V
V_{DC}	Maximum DC Blocking Voltage	1000	V
$I_{F(AV)}$	Average Rectified Forward Current (Note 1)	1.0	A
I_{FSM}	Peak Forward Surge Current (Note 2)	30	A
I^2t	I^2t Rating for fusing ($t < 8.3$ ms)	3.735	A ² S
T_J	Operating Junction Temperature Range	-55 to +150	°C
T_{STG}	Storage Temperature Range	-55 to +150	°C

Stresses exceeding those listed in the Maximum Ratings table may damage the device. If any of these limits are exceeded, device functionality should not be assumed, damage may occur and reliability may be affected.

1. 60 Hz sine wave, R-load, $T_A = 25^\circ\text{C}$ on FR-4 PCB.
2. 60 Hz sine wave, Non-repetitive 1 cycle peak value, $T_J = 25^\circ\text{C}$.

THERMAL CHARACTERISTICS (Note 3)

Symbol	Parameter	Typ.	Units
$R_{\theta JA}$	Thermal Resistance, Junction-Ambient	Measurement with Dual Dice	250 °C/W
		Measurement with Single Die	150 °C/W
ψ_{JL}	Thermal Characterization, Junction to Lead	Measured at Anode pin	57 °C/W
		Measured at Cathode pin	15 °C/W

3. Device mounted on FR-4 PCB with board size = 76.2 mm x 114.3 mm (JE51-3 standards).



ON Semiconductor®

www.onsemi.com

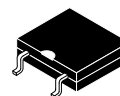
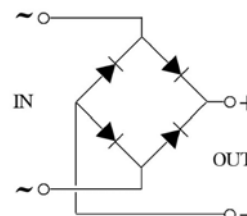

TSSOP4 4.975x4.375
CASE 948BT

MARKING DIAGRAM

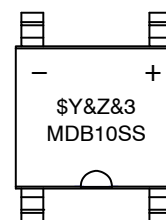

MDB10SS = Specific Device Code
 \$Y = ON Semiconductor Logo
 &Z = Assembly Plant Code
 &3 = Data Code (Year & Week)

ORDERING INFORMATION

Device	Package	Shipping
MDB10SS	TSSOP-4 (Pb-Free)	5000 / Tape & Reel

†For information on tape and reel specifications, including part orientation and tape sizes, please refer to our Tape and Reel Packaging Specification Brochure, [BRD8011/D](http://www.onsemi.com/BRD8011/D).

MDB10SS

ELECTRICAL CHARACTERISTICS Values are at $T_A = 25^\circ\text{C}$ unless otherwise specified.

Symbol	Parameter	Test condition	Value	Units
V_F	Maximum Forward Voltage	$I_F = 1\text{ A}$, Pulse measurement, Per diode	1.0	V
I_R	Maximum Reverse Current	At VRRM, Pulse measurement, Per diode	10	μA
C_J	Typical Junction Capacitance	$V_R = 4\text{ V}$, $f = 1\text{ MHz}$	10	pF

TYPICAL PERFORMANCE CHARACTERISTICS

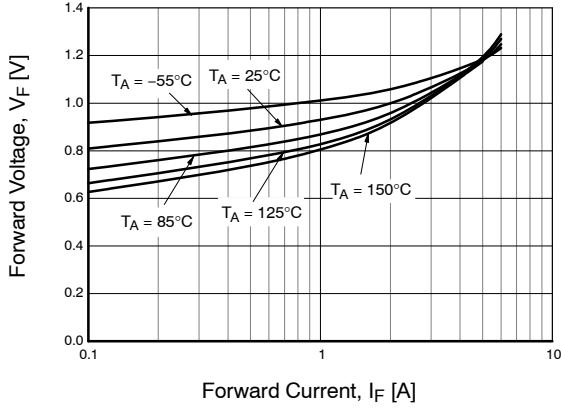

Figure 1. Forward Voltage vs Forward Current (Per diode)

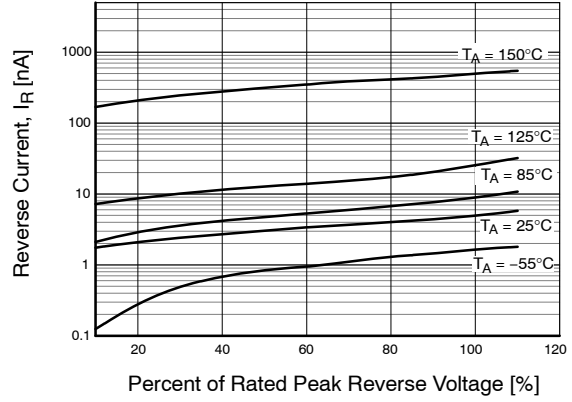

Figure 2. Typical Reverse Current Characteristics (Per Diode)

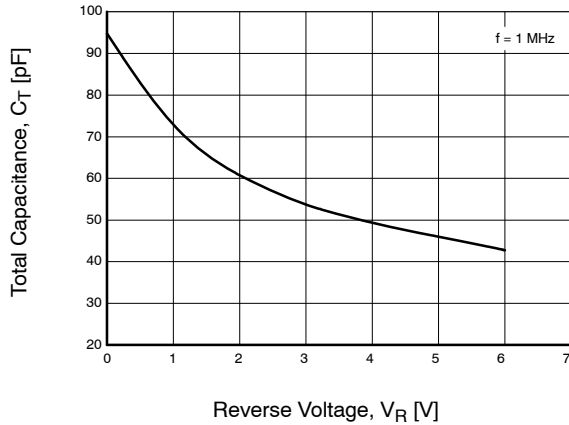
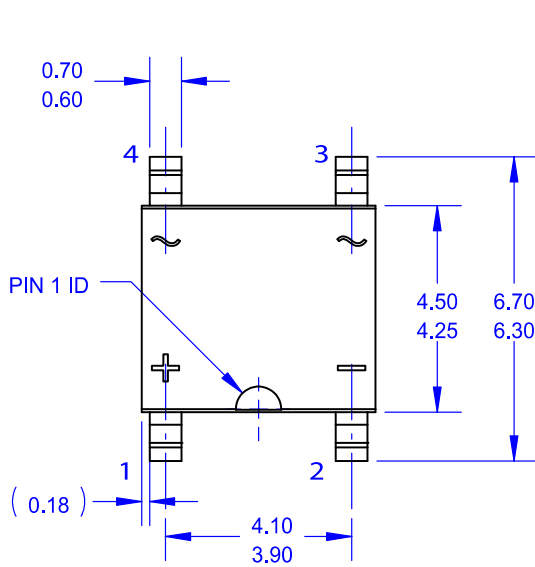

Figure 3. Total Capacitance

TSSOP4 4.975x4.375 / Micro-DIP
CASE 948BT
ISSUE O

DATE 30 NOV 2016



TOP VIEW

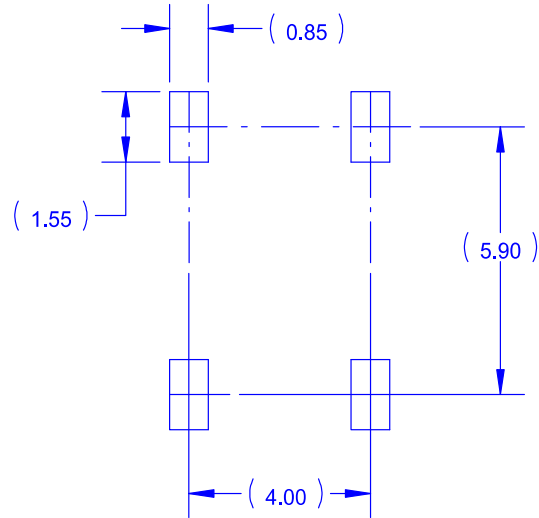

LAND PATTERN RECOMMENDATION

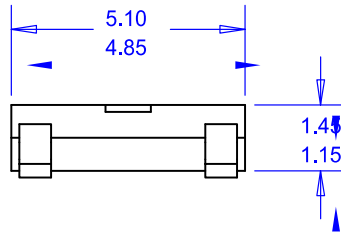

SIDE VIEW

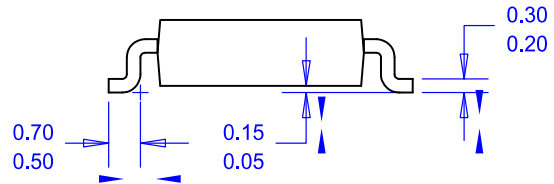

END VIEW

NOTES:

- A. THIS PACKAGE DOES NOT CONFORM TO ANY REFERENCE STANDARD.
- B. ALL DIMENSIONS ARE IN MILLIMETERS.
- C. DIMENSIONS ARE EXCLUSIVE OF BURRS, MOLD FLASH AND TIE BAR PROTRUSIONS.

DOCUMENT NUMBER:	98AON13796G	Electronic versions are uncontrolled except when accessed directly from the Document Repository. Printed versions are uncontrolled except when stamped "CONTROLLED COPY" in red.
DESCRIPTION:	TSSOP4 4.975x4.375 / Micro-DIP	PAGE 1 OF 1

ON Semiconductor and are trademarks of Semiconductor Components Industries, LLC dba ON Semiconductor or its subsidiaries in the United States and/or other countries. ON Semiconductor reserves the right to make changes without further notice to any products herein. ON Semiconductor makes no warranty, representation or guarantee regarding the suitability of its products for any particular purpose, nor does ON Semiconductor assume any liability arising out of the application or use of any product or circuit, and specifically disclaims any and all liability, including without limitation special, consequential or incidental damages. ON Semiconductor does not convey any license under its patent rights nor the rights of others.

onsemi, **Onsemi**, and other names, marks, and brands are registered and/or common law trademarks of Semiconductor Components Industries, LLC dba "**onsemi**" or its affiliates and/or subsidiaries in the United States and/or other countries. **onsemi** owns the rights to a number of patents, trademarks, copyrights, trade secrets, and other intellectual property. A listing of **onsemi**'s product/patent coverage may be accessed at www.onsemi.com/site/pdf/Patent-Marking.pdf. **onsemi** reserves the right to make changes at any time to any products or information herein, without notice. The information herein is provided "as-is" and **onsemi** makes no warranty, representation or guarantee regarding the accuracy of the information, product features, availability, functionality, or suitability of its products for any particular purpose, nor does **onsemi** assume any liability arising out of the application or use of any product or circuit, and specifically disclaims any and all liability, including without limitation special, consequential or incidental damages. Buyer is responsible for its products and applications using **onsemi** products, including compliance with all laws, regulations and safety requirements or standards, regardless of any support or applications information provided by **onsemi**. "Typical" parameters which may be provided in **onsemi** data sheets and/or specifications can and do vary in different applications and actual performance may vary over time. All operating parameters, including "Typicals" must be validated for each customer application by customer's technical experts. **onsemi** does not convey any license under any of its intellectual property rights nor the rights of others. **onsemi** products are not designed, intended, or authorized for use as a critical component in life support systems or any FDA Class 3 medical devices or medical devices with a same or similar classification in a foreign jurisdiction or any devices intended for implantation in the human body. Should Buyer purchase or use **onsemi** products for any such unintended or unauthorized application, Buyer shall indemnify and hold **onsemi** and its officers, employees, subsidiaries, affiliates, and distributors harmless against all claims, costs, damages, and expenses, and reasonable attorney fees arising out of, directly or indirectly, any claim of personal injury or death associated with such unintended or unauthorized use, even if such claim alleges that **onsemi** was negligent regarding the design or manufacture of the part. **onsemi** is an Equal Opportunity/Affirmative Action Employer. This literature is subject to all applicable copyright laws and is not for resale in any manner.

ADDITIONAL INFORMATION

TECHNICAL PUBLICATIONS:

Technical Library: www.onsemi.com/design/resources/technical-documentation
onsemi Website: www.onsemi.com

ONLINE SUPPORT: www.onsemi.com/support

For additional information, please contact your local Sales Representative at www.onsemi.com/support/sales

