

**EN** - For pricing and availability in your local country please visit one of the below links:

**DE** - Informationen zu Preisen und Verfügbarkeit in Ihrem Land erhalten Sie über die unten aufgeführten Links:

**FR** - Pour connaître les tarifs et la disponibilité dans votre pays, cliquez sur l'un des liens suivants:

[CM600HU-12F](#)

**EN**

This Datasheet is presented by  
the manufacturer

**DE**

Dieses Datenblatt wird vom  
Hersteller bereitgestellt

**FR**

Cette fiche technique est  
présentée par le fabricant

### Trench Gate Design Single IGBTMOD™ 600 Amperes/600 Volts

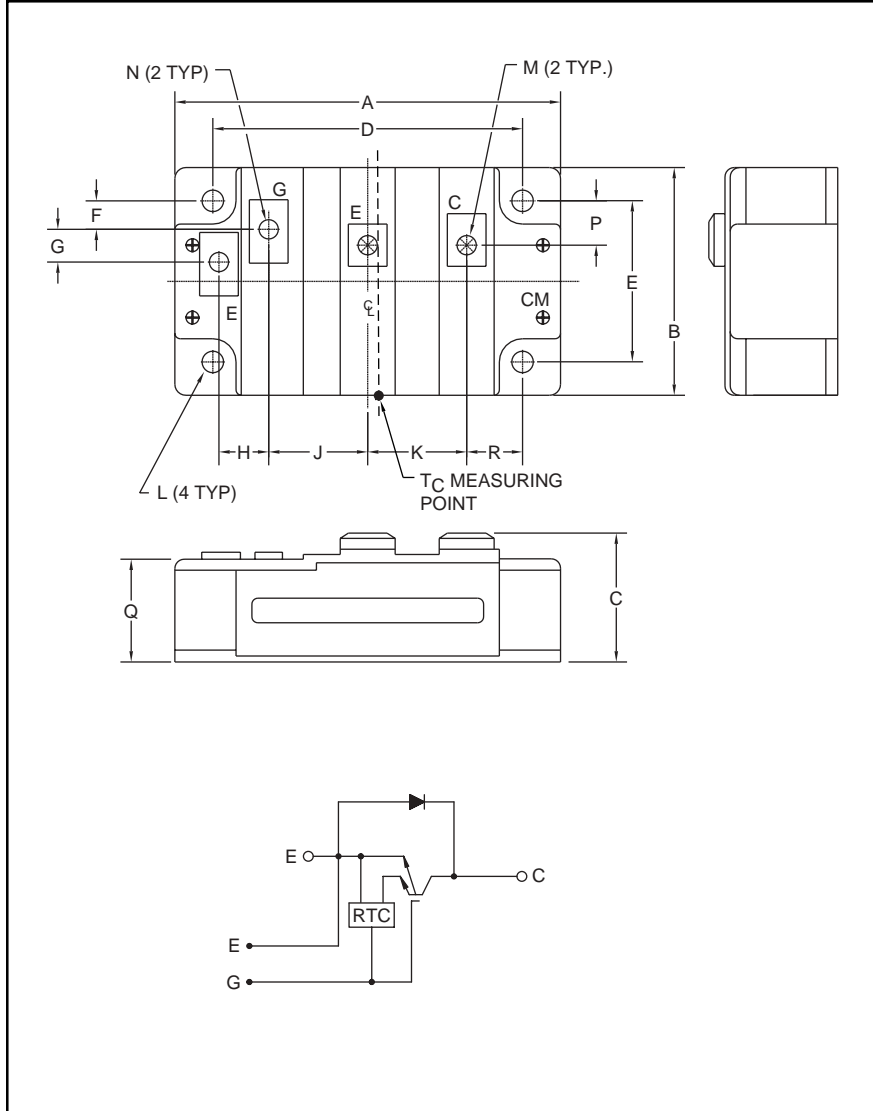

Outline Drawing and Circuit Diagram

Dimensions	Inches	Millimeters
A	4.21	107.0
B	2.44	62.0
C	1.34 +0.04/-0.02	34.0 +1.0/-0.5
D	3.66±0.01	93.0±0.25
E	1.88±0.01	48.0±0.25
F	0.37	9.5
G	0.39	10.0
H	0.53	13.5

Dimensions	Inches	Millimeters
J	1.02	26.0
K	1.14	29.0
L	0.26 Dia.	6.5 Dia.
M	M8	M8
N	M4	M4
P	0.49	12.55
Q	1.02 +0.04/-0.02	26.0 +1.0/-0.5
R	0.81	20.5



#### Description:

Powerex IGBTMOD™ Modules are designed for use in switching applications. Each module consists of one IGBT Transistor in a single configuration with a reverse-connected super-fast recovery free-wheel diode. All components and interconnects are isolated from the heat sinking baseplate, offering simplified system assembly and thermal management.

#### Features:

- Low Drive Power
- Low  $V_{CE(sat)}$
- Discrete Super-Fast Recovery Free-Wheel Diode
- Isolated Baseplate for Easy Heat Sinking

#### Applications:

- AC Motor Control
- UPS
- Battery Powered Supplies

#### Ordering Information:

Example: Select the complete module number you desire from the table - i.e. CM600HU-12F is a 600V ( $V_{CES}$ ), 600 Ampere Dual IGBTMOD™ Power Module.

Type	Current Rating Amperes	$V_{CES}$ Volts (x 50)
CM	600	12



Powerex, Inc., 200 Hillis Street, Youngwood, Pennsylvania 15697-1800 (724) 925-7272

**CM600HU-12F**  
**Trench Gate Design Single IGBTMOD™**  
 600 Amperes/600 Volts

**Absolute Maximum Ratings,  $T_j = 25^\circ\text{C}$  unless otherwise specified**

Ratings	Symbol	CM600HU-12F	Units
Junction Temperature	$T_j$	-40 to 150	$^\circ\text{C}$
Storage Temperature	$T_{\text{stg}}$	-40 to 125	$^\circ\text{C}$
Collector-Emitter Voltage (G-E SHORT)	$V_{\text{CES}}$	600	Volts
Gate-Emitter Voltage (C-E SHORT)	$V_{\text{GES}}$	$\pm 20$	Volts
Collector Current ( $T_c = 25^\circ\text{C}$ )	$I_c$	600	Amperes
Peak Collector Current ( $T_j \leq 150^\circ\text{C}$ )	$I_{\text{CM}}$	1200*	Amperes
Emitter Current** ( $T_c = 25^\circ\text{C}$ )	$I_E$	600	Amperes
Peak Emitter Current**	$I_{\text{EM}}$	1200*	Amperes
Maximum Collector Dissipation ( $T_c = 25^\circ\text{C}$ )	$P_c$	1420	Watts
Mounting Torque, M8 Main Terminal	–	95	in-lb
Mounting Torque, M6 Mounting	–	40	in-lb
Mounting Torque, M4 Terminal	–	15	in-lb
Weight	–	450	Grams
Isolation Voltage (Main Terminal to Baseplate, AC 1 min.)	$V_{\text{ISO}}$	2500	Volts

**Static Electrical Characteristics,  $T_j = 25^\circ\text{C}$  unless otherwise specified**

Characteristics	Symbol	Test Conditions	Min.	Typ.	Max.	Units
Collector-Cutoff Current	$I_{\text{CES}}$	$V_{\text{CE}} = V_{\text{CES}}, V_{\text{GE}} = 0\text{V}$	–	–	1	mA
Gate Leakage Current	$I_{\text{GES}}$	$V_{\text{GE}} = V_{\text{GES}}, V_{\text{CE}} = 0\text{V}$	–	–	80	$\mu\text{A}$
Gate-Emitter Threshold Voltage	$V_{\text{GE(th)}}$	$I_c = 60\text{mA}, V_{\text{CE}} = 10\text{V}$	5	6	7	Volts
Collector-Emitter Saturation Voltage	$V_{\text{CE(sat)}}$	$I_c = 600\text{A}, V_{\text{GE}} = 15\text{V}, T_j = 25^\circ\text{C}$	–	1.6	2.2	Volts
		$I_c = 600\text{A}, V_{\text{GE}} = 15\text{V}, T_j = 125^\circ\text{C}$	–	1.6	–	Volts
Total Gate Charge	$Q_G$	$V_{\text{CC}} = 300\text{V}, I_c = 600\text{A}, V_{\text{GE}} = 15\text{V}$	–	3720	–	nC
Emitter-Collector Voltage**	$V_{\text{EC}}$	$I_E = 600\text{A}, V_{\text{GE}} = 0\text{V}$	–	–	2.6	Volts

\* Pulse width and repetition rate should be such that the device junction temperature ( $T_j$ ) does not exceed  $T_{j(\text{max})}$  rating.

\*\* Represents characteristics of the anti-parallel, emitter-to-collector free-wheel diode (FWDi).

**CM600HU-12F**  
**Trench Gate Design Single IGBTMOD™**  
 600 Amperes/600 Volts

**Dynamic Electrical Characteristics,  $T_j = 25\text{ }^\circ\text{C}$  unless otherwise specified**

Characteristics	Symbol	Test Conditions	Min.	Typ.	Max.	Units
Input Capacitance	$C_{ies}$		–	–	160	nf
Output Capacitance	$C_{oes}$	$V_{CE} = 10V, V_{GE} = 0V$	–	–	11	nf
Reverse Transfer Capacitance	$C_{res}$		–	–	6	nf
Inductive	Turn-on Delay Time	$V_{CC} = 300V, I_C = 600A,$ $V_{GE1} = V_{GE2} = 15V,$	–	–	600	ns
Load	Rise Time					
Switch	Turn-off Delay Time	$R_G = 3.1\Omega,$ Inductive Load	–	–	900	ns
Times	Fall Time					
Diode Reverse Recovery Time**	$t_{rr}$	Switching Operation	–	–	300	ns
Diode Reverse Recovery Charge**	$Q_{rr}$	$I_E = 600A$	–	11.7	–	$\mu C$

**Thermal and Mechanical Characteristics,  $T_j = 25\text{ }^\circ\text{C}$  unless otherwise specified**

Characteristics	Symbol	Test Conditions	Min.	Typ.	Max.	Units
Thermal Resistance, Junction to Case	$R_{th(j-c)Q}$	Per IGBT, $T_C$ Reference Point per Outline Drawing	–	–	0.088	$^\circ\text{C/W}$
Thermal Resistance, Junction to Case	$R_{th(j-c)D}$	Per FWDi, $T_C$ Reference Point per Outline Drawing	–	–	0.12	$^\circ\text{C/W}$
Thermal Resistance, Junction to Case	$R_{th(j-c)'Q}$	Per IGBT, $T_C$ Reference Point Under Chip	–	0.04	–	$^\circ\text{C/W}$
Contact Thermal Resistance	$R_{th(c-f)}$	Per Module, Thermal Grease Applied	–	0.02	–	$^\circ\text{C/W}$

\*\* Represents characteristics of the anti-parallel, emitter-to-collector free-wheel diode (FWDi).



Powerex, Inc., 200 Hillis Street, Youngwood, Pennsylvania 15697-1800 (724) 925-7272

**CM600HU-12F**  
**Trench Gate Design Single IGBTMOD™**  
 600 Amperes/600 Volts

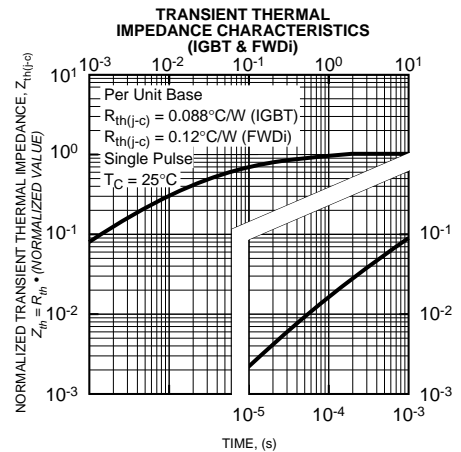
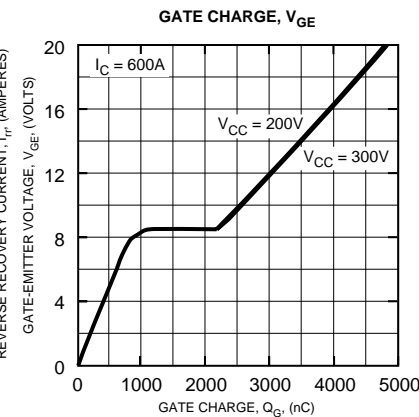
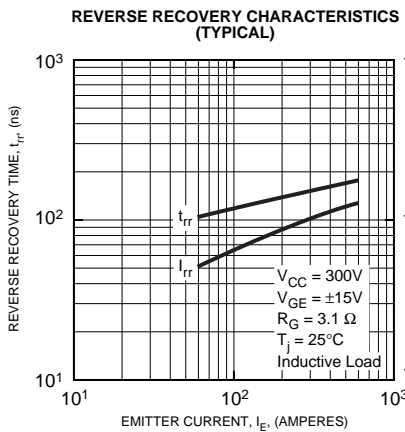
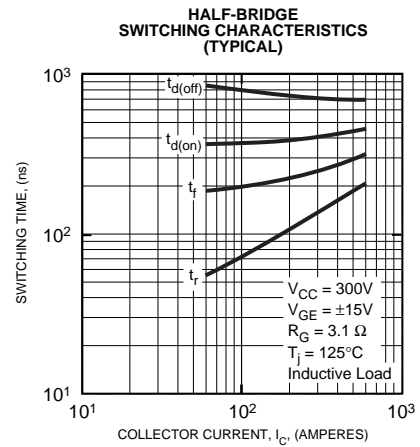
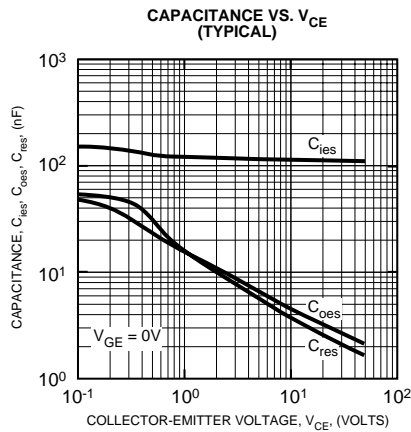
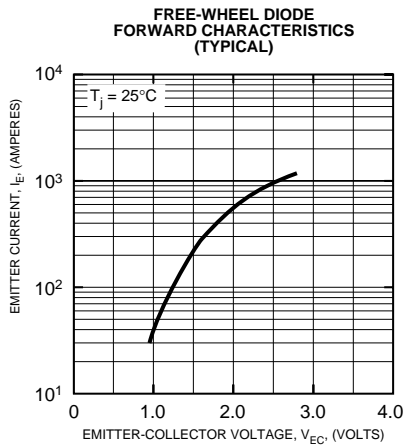
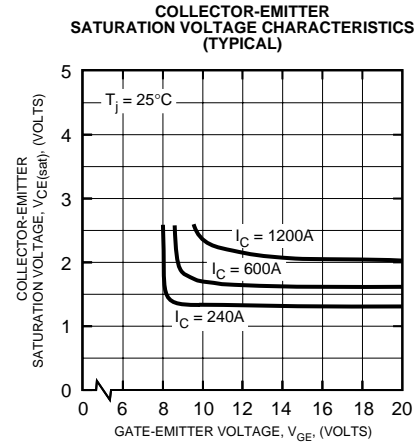
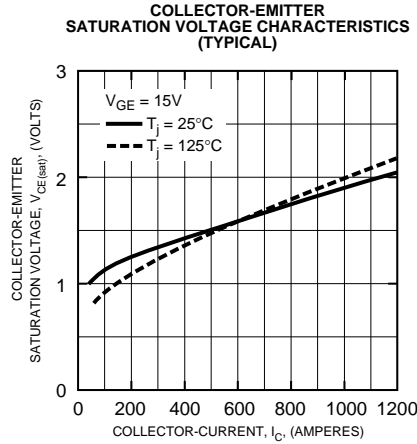
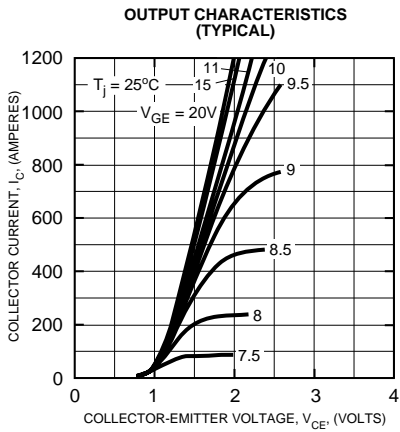

**EN** - For pricing and availability in your local country please visit one of the below links:

**DE** - Informationen zu Preisen und Verfügbarkeit in Ihrem Land erhalten Sie über die unten aufgeführten Links:

**FR** - Pour connaître les tarifs et la disponibilité dans votre pays, cliquez sur l'un des liens suivants:

[CM600HU-12F](#)

**EN**

This Datasheet is presented by  
the manufacturer

**DE**

Dieses Datenblatt wird vom  
Hersteller bereitgestellt

**FR**

Cette fiche technique est  
présentée par le fabricant