

# Catamount®

## Cable Clamps & Clips

### SELF-ALIGNING CABLE CLAMPS

- Molded-In Saddle Washer enhances Performance and Appearance
- Self-Alignment feature makes this Clamp Ideal for Assembly Applications
- 14 Diameters and 2 Widths with Mounting Holes for #4 through #10 Screws
- UL Flammability W.NY 94 V-2; W.TZ 94 V-0
- Stocked in Nylon, Heat Stabilized Black Nylon, and DuPont Tefzel for Highest Heat Applications
- Item Numbers Molded-in for Easy Identification

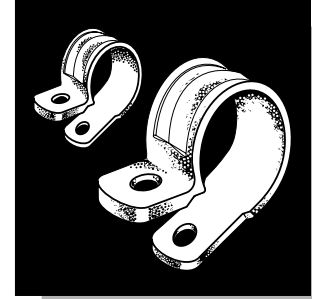
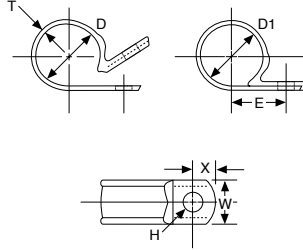

Item Number	Material	D Nominal Diameter Inch (mm)	D1 Closed Diameter Inch (mm)	E Inch (mm)	T Thickness Inch (mm)	W Width Inch (mm)	H Hole Diameter Inch (mm)	X Inch (mm)	Per Package
W4NY-125-9-M	Natural Nylon	.125 (3.17)	.114 (2.89)	.333 (8.46)	.040 (1.02)	.375 (9.52)	.167 (4.24)	.257 (6.53)	1000
W4NY-187-9-M		.187 (4.76)	.172 (4.36)	.355 (9.02)				.218 (5.53)	
W4NY-250-9-M		.250 (6.34)	.234 (5.94)	.382 (9.70)				.190 (4.83)	
W4NY-312-9-M		.312 (7.93)	.297 (7.54)	.422 (10.71)				.205 (5.21)	
W4NY-375-9-M		.375 (9.52)	.359 (9.11)	.454 (11.53)				.210 (5.33)	
W4NY-500-9-M		.500 (12.69)	.484 (12.29)	.490 (12.45)				.266 (6.76)	
W6NY-187-9-M		.187 (4.76)	.172 (4.36)	.375 (9.52)	.060 (1.52)	.500 (12.69)	.203 (5.15)	.241 (6.12)	
W6NY-250-9-M		.250 (6.34)	.234 (5.94)	.407 (10.34)				.280 (7.11)	
W6NY-312-9-M		.312 (7.93)	.297 (7.54)	.445 (11.30)				.291 (7.39)	
W6NY-375-9-M		.375 (9.52)	.359 (9.11)	.484 (12.29)				.263 (6.68)	
W6NY-437-9-M		.437 (11.11)	.422 (10.71)	.522 (13.25)				.272 (6.91)	
W6NY-500-9-M		.500 (12.69)	.484 (12.29)	.560 (14.22)				.236 (5.99)	
W6NY-562-9-M		.562 (14.28)	.547 (13.90)	.657 (16.68)				.290 (7.37)	
W6NY-625-9-M		.625 (15.87)	.609 (15.46)	.637 (16.17)				.327 (8.31)	
W6NY-687-9-M	.687 (17.46)	.672 (17.06)	.694 (17.63)	.326 (8.28)					
W6NY-750-9-M	.750 (19.04)	.734 (18.64)	.726 (18.44)	.323 (8.20)					
W6NY-812-9-M	.812 (20.63)	.797 (20.24)	.776 (19.71)	.310 (7.87)					
W6NY-875-9-D	.875 (22.22)	.859 (21.81)	.733 (18.62)	.292 (7.42)					
W6NY-1000-9-D	1.000(25.39)	.984 (24.99)	.881 (22.38)	.339 (8.61)					
W6NY-1250-9-D	1.250(31.73)	1.227(31.16)	1.010(25.65)						
W4NY-125-0-M	Heat Stabilized Black Nylon	.125 (3.17)	.114 (2.89)	.333 (8.46)	.040 (1.02)	.375 (9.52)	.167 (4.24)	.257 (6.53)	1000
W4NY-187-0-M		.187 (4.76)	.172 (4.36)	.355 (9.02)				.218 (5.53)	
W4NY-250-0-M		.250 (6.34)	.234 (5.94)	.382 (9.70)				.190 (4.83)	
W4NY-312-0-M		.312 (7.93)	.297 (7.54)	.422 (10.71)				.205 (5.21)	
W4NY-375-0-M		.375 (9.52)	.359 (9.11)	.454 (11.53)				.210 (5.33)	
W4NY-500-0-M		.500 (12.69)	.484 (12.29)	.490 (12.45)				.266 (6.76)	
W6NY-187-0-M		.187 (4.76)	.172 (4.36)	.375 (9.52)	.060 (1.52)	.500 (12.69)	.203 (5.15)	.241 (6.12)	
W6NY-250-0-M		.250 (6.34)	.234 (5.94)	.407 (10.34)				.280 (7.11)	
W6NY-312-0-M		.312 (7.93)	.297 (7.54)	.445 (11.30)				.291 (7.39)	
W6NY-375-0-M		.375 (9.52)	.359 (9.11)	.484 (12.29)				.263 (6.68)	
W6NY-437-0-M		.437 (11.11)	.422 (10.71)	.522 (13.25)				.272 (6.91)	
W6NY-500-0-M		.500 (12.69)	.484 (12.29)	.560 (14.22)				.236 (5.99)	
W6NY-562-0-M		.562 (14.28)	.547 (13.90)	.657 (16.68)				.290 (7.37)	
W6NY-625-0-M		.625 (15.87)	.609 (15.46)	.637 (16.17)				.327 (8.31)	
W6NY-687-0-M	.687 (17.46)	.672 (17.06)	.694 (17.63)	.326 (8.28)					
W6NY-750-0-M	.750 (19.04)	.734 (18.64)	.726 (18.44)	.323 (8.20)					
W6NY-812-0-M	.812 (20.63)	.797 (20.24)	.776 (19.71)	.310 (7.87)					
W6NY-875-0-D	.875 (22.22)	.859 (21.81)	.733 (18.62)	.292 (7.42)					
W6NY-1000-0-D	1.000(25.39)	.984 (24.99)	.881 (22.38)	.339 (8.61)					
W6NY-1250-0-D	1.250(31.73)	1.227(31.16)	1.010(25.65)						
Tolerance ±			.010 (.254)	.030 (.762)	.005 (.127)	.015 (.381)	.010 (.254)	.030 (.762)	

(Continued)

**Thomas&Betts**

# Catamount®

## Cable Clamps & Clips

### SELF-ALIGNING CABLE CLAMPS

Item Number	Material	D		E		T		W		H		X		Per Package
		Nominal Diameter Inch (mm)	Closed Diameter Inch (mm)	Inch (mm)	(mm)	Thickness Inch (mm)	(mm)	Width Inch (mm)	(mm)	Hole Diameter Inch (mm)	(mm)	Inch (mm)	(mm)	
W4TZ-125-5-D	Tefzel	.125 (3.17)	.114 (2.89)	.333 (8.46)		.040 (1.02)	.375 (9.52)	.167 (4.24)					500	
W4TZ-187-5-D		.187 (4.76)	.172 (4.36)	.355 (9.02)										
W4TZ-250-5-D		.250 (6.34)	.234 (5.94)	.382 (9.70)										
W4TZ-312-5-D		.312 (7.93)	.297 (7.54)	.422 (10.71)										
W4TZ-375-5-D		.375 (9.52)	.359 (9.11)	.454 (11.53)										
W4TZ-500-5-D		.500 (12.69)	.484 (12.29)	.490 (12.45)										
W6TZ-187-5-D		.187 (4.76)	.172 (4.36)	.375 (9.52)		.060 (1.52)	.500 (12.69)	.203 (5.15)						
W6TZ-250-5-D		.250 (6.34)	.234 (5.94)	.407 (10.34)										
W6TZ-312-5-D		.312 (7.93)	.297 (7.54)	.445 (11.30)										
W6TZ-375-5-D		.375 (9.52)	.359 (9.11)	.484 (12.29)										
W6TZ-437-5-D		.437 (11.11)	.422 (10.71)	.522 (13.25)										
W6TZ-500-5-D		.500 (12.69)	.484 (12.29)	.560 (14.22)										
W6TZ-625-5-D		.625 (15.87)	.609 (15.46)	.637 (16.17)		.030 (.762)								
W6TZ-750-5-D		.750 (19.04)	.734 (18.64)	.726 (18.44)										
<b>Tolerance ±</b>			.010 (.254)	.030 (.762)		.005 (.127)	.015 (.381)	.010 (.254)		.030 (.762)				

- Tefzel is a Trademark of the DuPont Corporation
- See our new Snap Mounts on page 28.

Patent No. 4535960

# The champ clamp.



**TEST SAMPLES**  
SENT WITH YOUR INQUIRY

UNIQUE SELF-ALIGNING FEATURE

• 2 STYLES • 2 WIDTHS  
• 19 DIAMETERS





**CATAMOUNT**

Catamount's Self-Aligning Cable Clamps have a molded-in alignment feature that make the clamp ideal for aesthetic or assembly applications.

Self-Aligning Clamps are available in 6/6 Nylon, Heat Stabilized Nylon, and DuPont Tefzel for extreme applications. Plain Edge Cable Clamps are also available.

Catamount manufactures a complete line of plastic fasteners including cable ties and accessories, clamps, clips, screws, nuts, bolts, spacers and standoffs. Catamount products are sold through stocking Catamount distributors nationwide.

**Try this clamp.**

**Thomas&Betts**

# Catamount®

## Cable Clamps & Clips

### TAB-LOK CABLE CLAMPS

- Adjustable Cable Clamp for Diameters to 3/4"
- Releasable and Reusable. Add or Remove Wires from Bundles as Required.
- #6 or #8 82° Flat Head Machine Screw to Mount
- Stocked in 6/6 Natural Nylon
- UL Flammability 94 V-2
- Non-Conductive, Non-Corrosive; Resistant to Fuels, Lubricants and most Chemicals

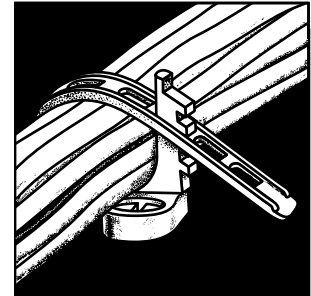
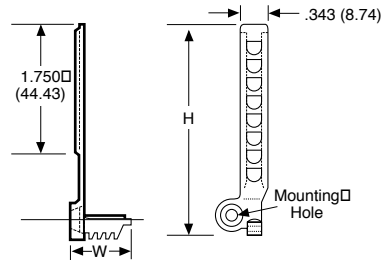

Item Number	Material	H Height Inch (mm)	W Width Inch (mm)	Adjustable Diameter Inch (mm)	Mounting Method	Per Package
TBNY-750-9-M	Natural Nylon	2.833 (71.96)	.850 (21.59)	.375 - .750 (9.52 - 19.05)	#6, #8 Flat Head Screw	1000
Tolerance ±		.030 (.762)	.015 (.381)			

### ADJUSTABLE CABLE CLAMPS

- Three Sizes for Bundles from .118" to .984"
- Ladder Style Fastener is easily Released and Refastened
- Supplied "Single-Cut" on a Rubber Based Closed Cell Foam Adhesive
- Stocked in 6/6 Gray Nylon
- UL Flammability 94 V-2 (clip)
- Optional Screw Hole for #4 or #5 Flat Head Screw

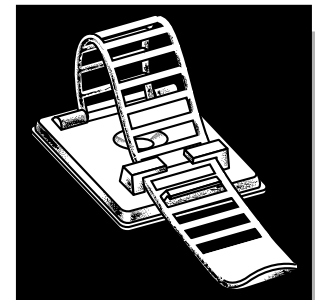
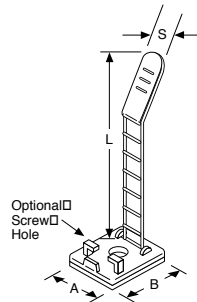

Item Number	Material	A Inch (mm)	B Inch (mm)	S Inch (mm)	L Inch (mm)	Applied Wire Range	Screw Hole Dia. Inch (mm)	Per Package
ULNY-013-8-C	Gray Nylon	.709 (18.00)	.984 (25.00)	.314 (8.00)	2.340 (59.50)	.118 - .500	.110 (2.79)	100
ULNY-018-8-C		.827 (21.00)	1.180 (30.00)	.472 (12.00)	3.120 (79.40)	.197 - .827		
ULNY-023-8-C		.984 (25.00)	1.380 (35.00)	.551 (14.00)	3.370 (85.50)	.275 - .984		
Tolerance ±		.015 (.381)		.010 (.254)	.030 (.762)			

# Catamount®

## Cable Clamps & Clips

### GATOR GRIP HOSE CLAMP

- 16 Sizes for Bundle Diameters to 2 3/8"
- Removable and Reusable. Twist by hand or with pliers to remove
- Stocked in Black Nylon. 100 Pieces per package
- UL Flammability 94 V-2
- Non-Conductive, Non-corrosive; Resistant to Fuels, Lubricants and most Chemicals
- Request Samples for Testing to your Application. Tested to 250 PSI

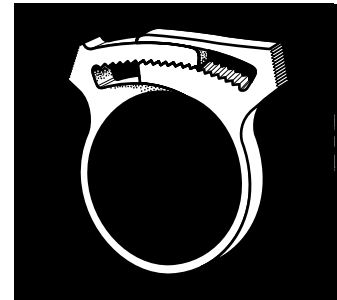
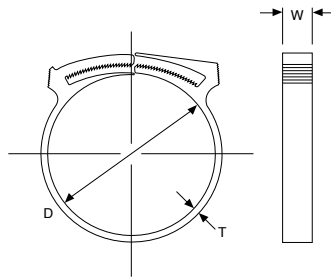

Item Number	D Nominal Diameter Inch (mm)	D1 Closed Diameter Inch (mm)	T Thickness Inch (mm)	W Width inch (mm)	Bulk Quantity
GGNY-344-0-C	<sup>13</sup> / <sub>32</sub> (10.32)	<sup>11</sup> / <sub>32</sub> (8.73)	.070 (1.8)	.220 (5.6)	100 Packs
GGNY-406-0-C	<sup>15</sup> / <sub>32</sub> (11.92)	<sup>13</sup> / <sub>32</sub> (10.32)			
GGNY-468-0-C	<sup>17</sup> / <sub>32</sub> (13.49)	<sup>15</sup> / <sub>32</sub> (11.91)			
GGNY-531-0-C	<sup>19</sup> / <sub>32</sub> (15.08)	<sup>17</sup> / <sub>32</sub> (13.49)			
GGNY-593-0-C	<sup>21</sup> / <sub>32</sub> (16.67)	<sup>19</sup> / <sub>32</sub> (15.08)		.310 (7.9)	
GGNY-672-0-C	<sup>13</sup> / <sub>16</sub> (20.64)	<sup>43</sup> / <sub>64</sub> (17.07)			
GGNY-750-0-C	<sup>7</sup> / <sub>8</sub> (22.23)	<sup>3</sup> / <sub>4</sub> (19.05)		.360 (9.1)	
GGNY-875-0-C	1 (25.40)	<sup>7</sup> / <sub>8</sub> (22.23)			
GGNY-953-0-C	<sup>13</sup> / <sub>32</sub> (27.78)	<sup>6</sup> / <sub>16</sub> (24.21)		.400 (10.2)	
GGNY-1031-0-C	<sup>119</sup> / <sub>16</sub> (30.16)	<sup>11</sup> / <sub>32</sub> (26.19)			
GGNY-1250-0-C	<sup>17</sup> / <sub>16</sub> (36.51)	<sup>11</sup> / <sub>4</sub> (31.75)			
GGNY-1406-0-C	<sup>15</sup> / <sub>8</sub> (41.28)	<sup>113</sup> / <sub>32</sub> (35.72)			
GGNY-1593-0-C	<sup>119</sup> / <sub>16</sub> (46.04)	<sup>119</sup> / <sub>32</sub> (40.48)			
GGNY-1687-0-C	<sup>129</sup> / <sub>32</sub> (48.42)	<sup>111</sup> / <sub>16</sub> (42.86)			
GGNY-1875-0-C	<sup>21</sup> / <sub>8</sub> (53.98)	<sup>11</sup> / <sub>8</sub> (47.63)			
GGNY-2125-0-C	<sup>21</sup> / <sub>8</sub> (60.33)	<sup>21</sup> / <sub>8</sub> (53.98)			
Tolerance ±	.010 (.254)				

# Catamount®

## Cable Clamps & Clips

### FLEX CLIPS

- Utilizes Nylon's "Memory" to Retain Original Shape even after Repeated Use
- Ideal for Temporary Applications
- Mounts with one #8 Machine Screw
- Stocked in Natural 6/6 Nylon
- UL Flammability 94 V-2
- Non-Conductive, Non-Corrosive; Resistant to Fuels, Lubricants and most Chemicals

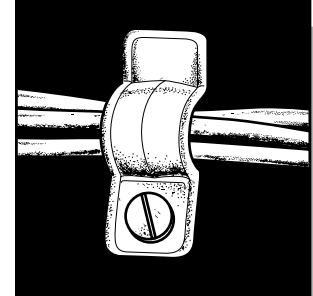
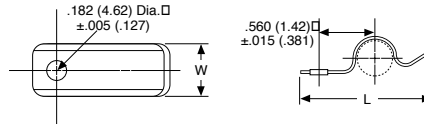

Item Number	Material	L Length Inch (mm)	W Width Inch (mm)	Max. Cable Diameter Inch (mm)	Mounting Method	Per Package
FCNY-312-9-M	Natural Nylon	1.350 (34.29)	.500 (12.69)	.312 (7.93)	#8 Screw	1000
Tolerance ±		.020 (.508)	.015 (.381)			

### HALF CLAMPS

- Rugged Clamps with Reinforced Side Panels for Bundle Diameters to .484"
- .203 Mounting Hole accepts #6 through #10 Screws
- Stocked in 6/6 Natural and Heat Stabilized Black Nylon
- UL Flammability 94 V-2
- Non-Conductive, Non-Corrosive; Resistant to Fuels, Lubricants and most Chemicals

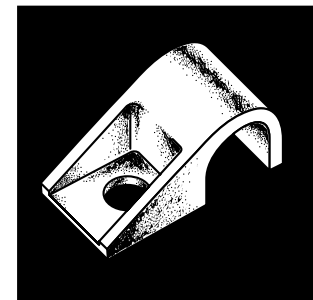
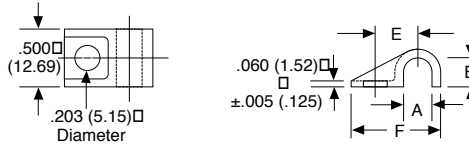

Item Number	Material	Inch A (mm)	Inch B (mm)	Inch E (mm)	Inch F (mm)	Per Package
CPNY-115-9-M	Natural Nylon	.115 (2.92)	.115 (2.92)	.314 (7.98)	.675 (17.15)	1000
CPNY-172-9-M		.172 (4.36)	.172 (4.36)	.336 (8.53)	.732 (18.59)	
CPNY-234-9-M		.234 (5.94)	.234 (5.94)	.370 (9.40)	.793 (20.14)	
CPNY-297-9-M		.297 (7.54)	.297 (7.54)	.400 (10.16)	.859 (21.82)	
CPNY-359-9-M		.359 (9.11)	.359 (9.11)	.435 (11.05)	.920 (23.37)	
CPNY-422-9-M		.422 (10.71)	.422 (10.71)	.470 (11.94)	.980 (24.89)	
CPNY-484-9-M		.484 (12.29)	.484 (12.29)	.500 (12.69)	1.044 (26.52)	
CPNY-115-0-M	Heat Stabilized Black Nylon	.115 (2.92)	.115 (2.92)	.314 (7.98)	.675 (17.15)	
CPNY-172-0-M		.172 (4.36)	.172 (4.36)	.336 (8.53)	.732 (18.59)	
CPNY-234-0-M		.234 (5.94)	.234 (5.94)	.370 (9.40)	.793 (20.14)	
CPNY-297-0-M		.297 (7.54)	.297 (7.54)	.400 (10.16)	.859 (21.82)	
CPNY-359-0-M		.359 (9.11)	.359 (9.11)	.435 (11.05)	.920 (23.37)	
CPNY-422-0-M		.422 (10.71)	.422 (10.71)	.470 (11.94)	.980 (24.89)	
CPNY-484-0-M		.484 (12.29)	.484 (12.29)	.500 (12.69)	1.044 (26.52)	
Tolerance ±		.010 (.254)		.015 (.381)		

**Thomas & Betts**

# Catamount®

## Cable Clamps & Clips

### PRESS CLIPS

- 4 Sizes to Accommodate Bundles up to 1/2"
- Clips are provided "Two-Up" on a Rubber Based Closed Cell Foam Adhesive
- Stocked in 6/6 Natural Nylon. Contact Factory for availability in Special Materials
- UL Flammability 94 V-2 (clip)

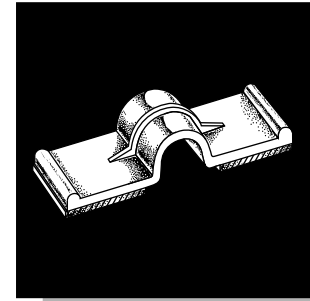
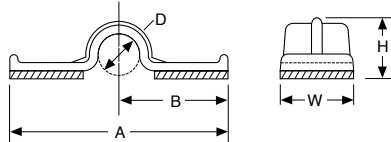

Item Number	Material	D Diameter		A		B		H		W		Per Package
		Inch	(mm)	Inch	(mm)	Inch	(mm)	Inch	(mm)	Inch	(mm)	
PCNY-125-9-D	Natural Nylon	.125	(3.17)	.760	(19.30)	.380	(9.65)	.211	(5.36)	.375	(9.52)	500
PCNY-250-9-D		.250	(6.35)	1.380	(35.05)	.690	(17.52)	.324	(8.23)	.500	(12.69)	
PCNY-375-9-D		.375	(9.52)	1.470	(37.32)	.735	(18.61)	.444	(11.29)	.625	(15.87)	
PCNY-500-9-D		.500	(12.69)	1.590	(40.57)	.795	(20.19)	.585	(14.85)	.750	(19.05)	
Tolerance ±		.010	(.254)	.020	(.508)			.010	(.254)			

### HALF PRESS CLIPS

- 4 Sizes to Accommodate Bundles up to 1/2"
- Clips are provided "Two-Up" on a Rubber Based Closed Cell Foam Adhesive
- Stocked in 6/6 Natural Nylon. Contact Factory for availability in Special Materials.
- UL Flammability 94 V-2 (clip)

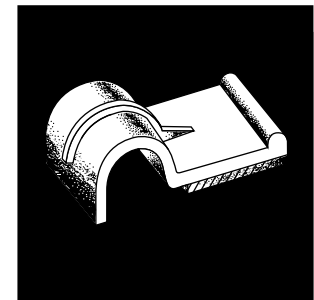
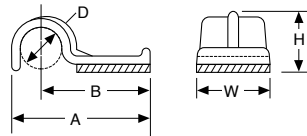

Item Number	Material	D Diameter		A		B		H		W		Per Package
		Inch	(mm)	Inch	(mm)	Inch	(mm)	Inch	(mm)	Inch	(mm)	
HCNY-125-9-M	Natural Nylon	.125	(3.17)	.493	(12.52)	.380	(9.65)	.180	(4.57)	.375	(9.52)	1000
HCNY-250-9-M		.250	(6.35)	.865	(21.97)	.690	(17.52)	.325	(8.25)	.500	(12.69)	
HCNY-375-9-M		.375	(9.52)	.980	(24.88)	.750	(19.05)	.415	(10.54)	.625	(15.87)	
HCNY-500-9-M		.500	(12.69)	1.110	(28.19)	.820	(20.83)	.560	(14.22)	.750	(19.05)	
Tolerance ±		.010	(.254)	.020	(.508)			.010	(.254)			

# Catamount®

## Cable Clamps & Clips

### FLAT CABLE CLIPS

- Low Profile Clip for Single or Multiple Layers of Flat Ribbon Cable
- FANY supplied "Two-Up" on a Rubber Based Closed Cell Foam Adhesive
- Screw Mountable with a #4 Flat Head Screw
- Flexible Tangs allow for easy Removal and Replacement of desired cable
- Stocked in 6/6 Natural Nylon
- UL Flammability 94 V-2 (clip)

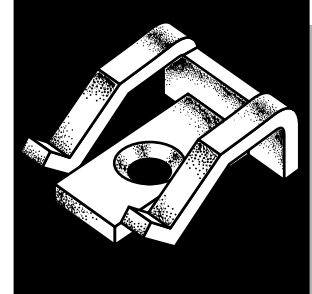
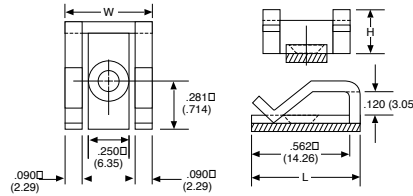

Item Number	Material	H Height Inch (mm)	L Length Inch (mm)	W Width Inch (mm)	Mounting Method	Per Package
FANY-562-9-D	Natural Nylon	.264 (6.70)	.625 (15.87)	.500 (12.69)	Adhesive	500
FSNY-562-9-D		.233 (5.92)			#4 Screw	
Tolerance ±		.010 (.254)	.015 (.381)			

### FLAT CABLE SCREW CLIP

- Flat Ribbon Cable Clamp with Mounting Hole for #8 Screw
- Stocked in Natural 6/6 Nylon
- Flexible Center Tang allows for easy Removal and Replacement of desired cable
- UL Flammability 94 V-2
- Non-Conductive, Non-Corrosive; Resistant to Fuels, Lubricants and most Chemicals

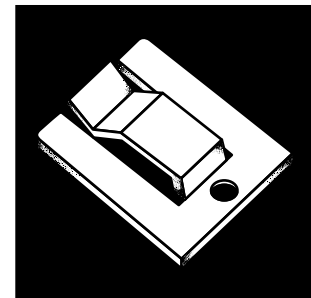
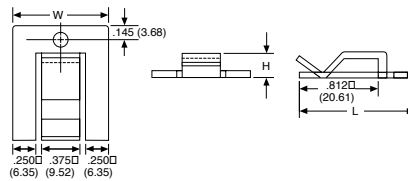

Item Number	Material	H Height Inch (mm)	L Length Inch (mm)	W Width Inch (mm)	Mounting Method	Per Package
FSNY-812-9-D	Natural Nylon	.125 (3.17)	1.187 (30.15)	1.000 (25.40)	#8 Screw	500
Tolerance ±		.010 (.254)	.015 (.381)			

# Catamount®

## Cable Clamps & Clips

### FLAT ADHESIVE CLIPS

- Low Profile Clip for Single or Multiple Layers of Flat Ribbon Cable
- Supplied "Two-Up" on a Rubber Based Closed Cell Foam Adhesive
- Flexible Center Tang for Removal or Addition of Cables
- Stocked in 6/6 Natural Nylon
- UL Flammability 94 V-2 (clip)

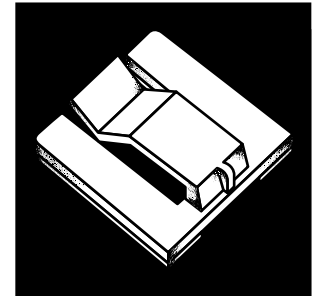
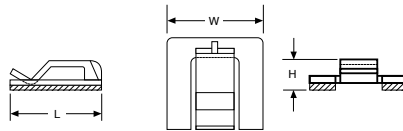

Item Number	Material	H Height Inch (mm)	L Length Inch (mm)	W Width Inch (mm)	Mounting Method	Per Package
FANY-812-9-D	Natural Nylon	.281 (7.14)	1.000 (25.40)	1.000 (25.40)	Adhesive	500
Tolerance ±		.010 (.254)	.015 (.381)			

### FLAT PVC CLIPS

- Low Profile Clip for Single or Multiple Layers of Flat Ribbon Cable
- "Single-Cut" on a Rubber Based Closed Cell Foam Adhesive
- Gray PVC
- UL Flammability 94 V-0 (clip)

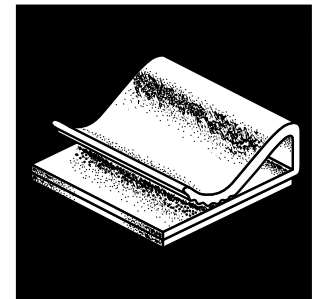
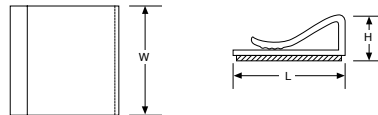

Item Number	Material	H Height Inch (mm)	L Length Inch (mm)	W Width Inch (mm)	Mounting Method	Per Package
FRPV-1000-8-D	Gray PVC	.230 (5.84)	1.062 (26.97)	1.000 (25.40)	Adhesive	500
Tolerance ±		.015 (.381)	.030 (.762)	.015 (.381)		



# Catamount®

## Cable Clamps & Clips

### STUD BUTTONS

- Utilize Nylon's "Memory" to Retain Original Shape after Compression
- Part Numbers contain Recommended Mounting Hole Diameters
- For use with Catamount Strapping or Panel Thickness through .165" with Mounting Holes through #1/4
- Stocked in Heat Stabilized Black Nylon for High Heat Applications
- UL Flammability 94 V-2

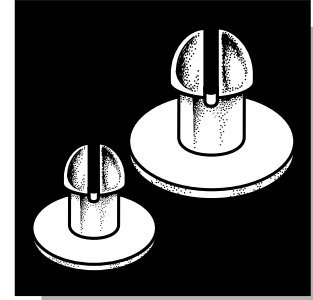
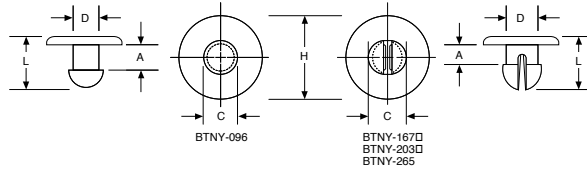

Item Number	H Head Dia.		A		C		D		L		Per Package
	Inch	(mm)	Inch	(mm)	Inch	(mm)	Inch	(mm)	Inch	(mm)	
BTNY-096-0-D	.281	(7.13)	.093	(2.36)	.105	(2.66)	.093	(2.36)	.206	(5.23)	500
BTNY-167-0-D	.343	(8.71)	.125	(3.17)	.202	(5.13)	.165	(4.19)	.297	(7.54)	
BTNY-203-0-D	.468	(11.88)	.156	(3.96)	.238	(6.04)	.200	(5.08)	.359	(9.11)	
BTNY-265-0-D	.580	(14.73)	.171	(4.34)	.300	(7.62)	.260	(6.60)	.410	(10.41)	
Tolerance ±					.010	(.254)					

### SNAP MOUNTS

- For Panel Thicknesses from .060" to .150" to Hold Separate Pieces of Material Together
- Used with W4 or N4 Series Cable Clamps; Allowable Panel Thickness is .030" to .050"
- Stocked in Natural 6/6 Nylon
- UL Flammability 94 V-2
- Non-Conductive, Non-Corrosive, Resistant to Fuels, Lubricants and most Chemicals

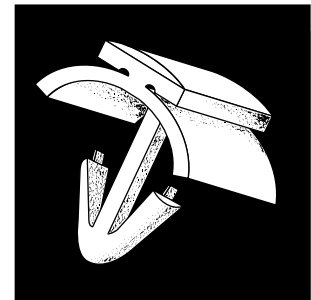
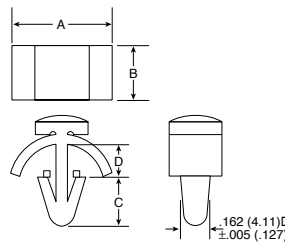

Item Number	Material	A		B		C		D		Per Package	
		Inch	(mm)	Inch	(mm)	Inch	(mm)	Inch	(mm)		
MSNY-166-9-M	Natural Nylon	.485	(12.32)	.312	(7.93)	.281	(7.14)	.180	(4.57)	1000	
Tolerance ±					.010	(.254)					

# Catamount®

## Cable Clamps & Clips

### TUBE CLIPS

- Push Mount Clips For Tubing Up To .357" Outside Diameter
- Use in 1/4" Mounting Hole
- Flexible for Panel Thicknesses from .040" to .125"
- Available in 6/6 Natural Nylon
- Non-Conductive, Non-Corrosive; Resistant To Fuels, Lubricants and Most Chemicals

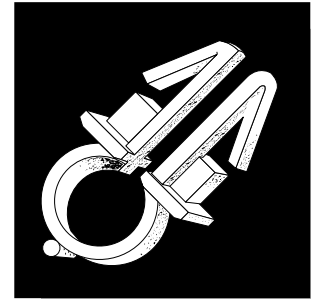
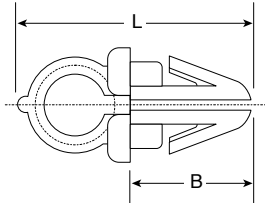

Item Number	Length	Bundle Diameter	Barb Length	Mounting Hole Dia.	Panel Thickness	Per Package
TCNY-250-9-D	.820	.250	.420	.250	.030 - .125	500
TCNY-375-9-D	.980	.375	.440			
<b>Tolerance ±</b>	.015			.015		

### ROUND ADHESIVE CLIPS

- Diverse Cable Clamps for Bundle Diameters from .160 to .620
- Two-Up on a Rubber Based Closed Cell Foam Adhesive
- Natural Nylon
- UL Flammability 94 V-2 (clip)
- Flexible Center Tang for Removal or Addition of Cables

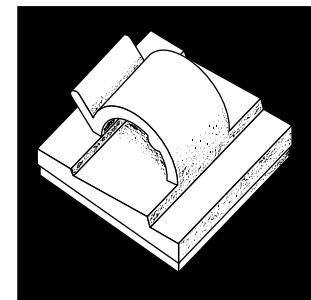
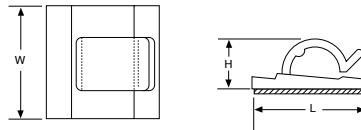

Item Number	Material	H Height Inch (mm)	L Length Inch (mm)	W Width Inch (mm)	Maximum Bundle	Mounting Method	Per Package
RANY-160-9-D	Natural Nylon	.250 (6.35)	.630 (16.00)	.580 (14.73)	.160	Rubber Based Adhesive	500
RANY-280-9-D		.410 (10.41)	1.000 (25.40)	1.000 (25.40)	.280		
RANY-530-9-D		.620 (15.75)	1.000 (25.40)	1.000 (25.40)	.530		
RANY-620-9-D		.560 (14.22)	1.250 (31.75)	1.120 (28.45)	.620		
<b>Tolerance ±</b>		.015	(.381)				

- Available July 1996.