

TM-T70II-DT for Linux

Technical Reference Guide

Product Overview

Describes features and general specifications for the product.

Setup

Describes setup and installation of the product and peripherals.

Preinstalled OS Information

Describes the preinstall information and recovery method.

Utility

Describes the utilities included in this product and how to use them.

Application Development Information

Describes how to control the printer and information necessary when you develop applications.

Handling

Describes how to handle the product.

Appendix

Describes character code tables.

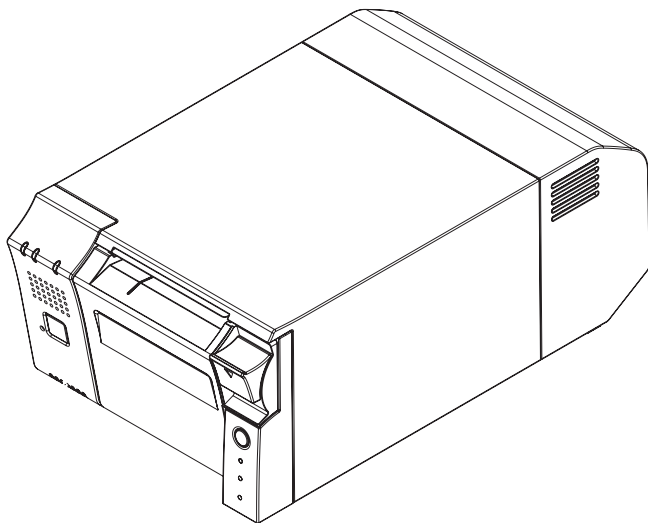

Cautions

- No part of this document may be reproduced, stored in a retrieval system, or transmitted in any form or by any means, electronic, mechanical, photocopying, recording, or otherwise, without the prior written permission of Seiko Epson Corporation.
- The contents of this document are subject to change without notice. Please contact us for the latest information.
- While every precaution has been taken in the preparation of this document, Seiko Epson Corporation assumes no responsibility for errors or omissions.
- Neither is any liability assumed for damages resulting from the use of the information contained herein.
- Neither Seiko Epson Corporation nor its affiliates shall be liable to the purchaser of this product or third parties for damages, losses, costs, or expenses incurred by the purchaser or third parties as a result of: accident, misuse, or abuse of this product or unauthorized modifications, repairs, or alterations to this product, or (excluding the U.S.) failure to strictly comply with Seiko Epson Corporation's operating and maintenance instructions.
- Seiko Epson Corporation shall not be liable against any damages or problems arising from the use of any options or any consumable products other than those specified as Original EPSON Products or EPSON Approved Products by Seiko Epson Corporation.

Trademarks

EPSON is a registered trademark of Seiko Epson Corporation in Japan and other countries/regions.

openSUSE is a registered trademark of SUSE LLC in the United States and other countries.



Linux is the registered trademark of Linus Torvalds in the U.S. and other countries.

Copyright © 2013 Seiko Epson Corporation. All rights reserved.

For Safety

Key to Symbols

The symbols in this manual are identified by their level of importance, as defined below. Read the following carefully before handling the product.

 WARNING	You must follow warnings carefully to avoid serious bodily injury.
 CAUTION	Provides information that must be observed to prevent damage to the equipment or loss of data. <ul style="list-style-type: none">• Possibility of sustaining physical injuries.• Possibility of causing physical damage.• Possibility of causing information loss.
CAUTION	Provides information that must be observed to avoid damage to your equipment or a malfunction.
NOTE	Provides important information and useful tips.

Warnings



WARNING

- **To avoid risk of electric shock, do not set up this product or handle cables during a thunderstorm.**
- **Never insert or disconnect the power plug with wet hands.**
Doing so may result in severe shock.
- **Handle the power cable with care.**
Improper handling may lead to fire or electric shock.
 - * Do not modify or attempt to repair the cable.
 - * Do not place any heavy object on top of the cable.
 - * Avoid excessive bending, twisting, and pulling.
 - * Do not place the cable near heating equipment.
 - * Check that the plug is clean before plugging it in.
 - * Be sure to push the plug all the way in.
- **Be sure to use the specified power source.**
Connection to an improper power source may cause fire or shock.
- **Do not place multiple loads on the power outlet.**
Overloading the outlet may lead to fire or shock.
- **Shut down your equipment immediately if it produces smoke, a strange odor, or unusual noise.**
Continued use may lead to fire. Immediately unplug the equipment and contact your dealer or a Seiko Epson service center for advice.
- **Never attempt to repair this product yourself.**
Improper repair work can be dangerous.
- **Never disassemble or modify this product.**
Tampering with this product may result in injury or fire.
- **Do not allow foreign matter to fall into the equipment.**
Penetration by foreign objects may lead to fire.
- **If water or other liquid spills into this equipment, do not continue to use it.**
Continued use may lead to fire. Unplug the power cord immediately and contact your dealer or a Seiko Epson service center for advice.
- **Do not use aerosol sprayers containing flammable gas inside or around this product.**
Doing so may cause fire.

Cautions



- **Do not connect cables in ways other than those mentioned in this manual.**
Different connections may cause equipment damage or fire.
- **Be sure to set this equipment on a firm, stable, horizontal surface.**
The product may break or cause injury if it falls.
- **Do not use this product in locations subject to high humidity or dust levels.**
Excessive humidity and dust may cause equipment damage or fire.
- **Do not place heavy objects on top of this product. Never stand or lean on this product.**
Equipment may fall or collapse, causing breakage and possible injury.
- **To avoid injury, do not insert fingers or any part of the hand in the roll paper opening where the manual cutter is installed.**
- **Do not open the roll paper cover without taking the necessary precautions, as this can result in injury from the autocutter fixed blade.**
- **To ensure safety, unplug this product before leaving it unused for an extended period.**

Wireless LAN (OT-WL01) Important Safety Information



- **May exert electromagnetic interference on, and cause malfunction of, cardiac pacemakers.**
Before using this product, check that there is no one in the vicinity using a cardiac pacemaker.
- **May exert electromagnetic interference on, and cause malfunction of, sensitive medical equipment.**
Before using this product, check that there is no sensitive medical equipment in the vicinity.
- **Use of this product on aircraft may be restricted in some countries.**
Before using this product, check that use of this product is not restricted on the aircraft.
- **Never attempt to repair this product yourself.**
Improper repair work can be dangerous.
- **Never disassemble or modify this product.**
Tampering with this product may result in injury or fire.



- **The OT-WL01 is only for indoor use.**
- **The OT-WL01 should only be used for EPSON TM-i series and TM-DT series.**
If it is installed on another device, it may result in computer failure, damage, or malfunctions.
- **To comply with RF exposure compliance requirements, a distance of at least 20 cm must be maintained at all times between the antenna of OT-WL01 and people in the vicinity.**
- **Do not store in locations with high temperatures or high humidity.**
It may in particular be damaged or deformed if left in a vehicle with the windows shut, or placed in locations with unusually high temperatures for extended periods such as in direct sunlight.
- **Do not wet the OT-WL01.**
This may cause malfunctions to occur.
- **Do not use near microwave ovens.**
Wireless communication may be interrupted by electromagnetic interference generated by microwave ovens.
- **Do not drop it, subject it to shocks, or place heavy objects on it.**

Wireless LAN (OT-WL01) Usage Precautions

Wireless Telegraphy Act Regulations

The following acts are prohibited by the Wireless Telegraphy Act.

- Modifying and disassembling (including the antenna)
- Removing the label of conformance

Notes on Security when Using Wireless LAN

Important information on customer rights (maintaining privacy)

The advantage of using a wireless LAN over a LAN cable is that, because information is exchanged using radio signals, you can easily connect to the network if you are within range of the radio signals. A disadvantage of this is that within a certain range, the electromagnetic signals can pass through barriers such as walls, so that if security countermeasures are not implemented in some way, problems such as the following may occur.

- Communication data can be intercepted
A third party may be able to receive wireless transmissions without authorization, and they could obtain personal information from these transmissions such as IDs, passwords, or credit card numbers, or they could intercept the contents of personal e-mail messages.
- Unauthorized access to the network
A third party could access an individual or intra-company network without permission and carry out any of the following activities.
 - Retrieve personal data or other secret information (information leakage)
 - Pose as another user and send inappropriate data (impersonation)
 - Overwrite the contents of intercepted data and resend it (falsification)
 - Introduce a computer virus which could cause data loss or system crashes (damage)

Initially, the possibility that such problems could occur through settings concerning the security of the wireless LAN product and by using the product are decreased, because the wireless LAN card and the access point have security measures to deal with these problems. We recommend that you use this product after making security settings using our own judgement and assuming full responsibility, and with your full understanding of problems that may occur if you do not make any security settings.

Notes on Setting SSID (Service Set Identifier)

For protection of security, note the following precautions when setting the SSID.

- Change the SSID from the default setting.
- Do not set texts by which the owner can be identified as the SSID.

Notes on Setting Cryptographic Key

For protection of security, note the following precautions when setting the cryptographic key.

- Avoid using words on a dictionary as practicably as possible.
- Combine meaningless alphanumeric characters and symbols.
- Use texts consisted of at least 13 characters or more or of 20 characters or more if possible.

Restriction of Use

When this product is used for applications requiring high reliability/safety, such as transportation devices related to aviation, rail, marine, automotive, etc.; disaster prevention devices; various safety devices, etc.; or functional/precision devices, etc., you should use this product only after giving consideration to including fail-safes and redundancies into your design to maintain safety and total system reliability. Because this product was not intended for use in applications requiring extremely high reliability/safety, such as aerospace equipment, main communication equipment, nuclear power control equipment, or medical equipment related to direct medical care, etc., please make your own judgment on this product's suitability after a full evaluation.

About this Manual

Aim of the Manual

This manual was created to provide information on development, design, and installation of receipt issue systems and development and design of printer applications for developers.

Manual Content

The manual is made up of the following sections:

Chapter 1	Product Overview
Chapter 2	Setup
Chapter 3	Preinstalled OS Information
Chapter 4	Utility
Chapter 5	Application Development Information
Chapter 6	Handling
Appendix	Character Code Tables

Contents

■ For Safety	3
Key to Symbols	3
Warnings	4
Cautions	5
Wireless LAN (OT-WL01) Important Safety Information	6
Wireless LAN (OT-WL01) Usage Precautions	6
■ Restriction of Use	8
■ About this Manual	9
Aim of the Manual	9
Manual Content	9
■ Contents	10
<hr/>	
Product Overview	15
■ Features	15
System connection examples	17
■ Product Configurations	21
Models	21
Paper width	21
Colors	21
Accessories	22
Related manuals	22
Peripherals	22
■ Part Names and Functions	23
Control Panel	24
Storage access LED and status LED	25
Connectors	26
■ Printer function	27
Error Status	27
■ NV Memory (Non-Volatile Memory)	29
■ Product Specifications	31
Power capacity to the exterior	32
Software Specifications	32
Printing Specifications	33
Character Specifications	34
Printable Area	35
Printing and Cutting Positions	36
Paper Specifications	37
Environmental Conditions	38
External Dimensions	39
TM-T70II-DT Dedicated AC Adapter	40

■ Option Specifications	41
Wireless LAN Cable Set (OT-WL01)	41
Customer Display DM-D110 (Dedicated customer display).....	42
<hr/>	
Setup	43
■ Updating the ePOS-Device	43
■ Flow of Setup	44
■ Installing the Product	47
Important Notes.....	48
Affixing Position of DF-10.....	48
■ Connecting the AC Adapter	49
Connecting the AC adapter	49
■ OS Initial Settings	50
■ Enabling or Disabling ePOS-Device	51
■ Connecting to the Network	52
For Ethernet Interface	52
For Wireless LAN Interface.....	56
■ Installing Drivers and Applications	64
Installing the Drivers	64
Installing Applications	64
■ Service Startup Settings	65
■ Registering Web Contents	67
Registering Web content.....	69
■ Registering device control script files	70
■ Attaching the Optional Customer Display	71
Setting the Customer Display	71
Connecting the Customer Display	72
■ Connecting External Devices	73
Connecting a Mouse and Keyboard.....	73
Connecting a Display	73
Connecting a Printer.....	73
Connection POS Peripherals	74
Connecting the Cash Drawer	75
■ Setting the Devices	77
Registering a Printer.....	77
Customer Display Settings	79
Registering a Key Input Device	80
Serial Communication Device Registration.....	82
Registering Other Devices	84

■ Printer Settings	85
Setting the Memory Switches/Receipt Enhancement	85
Registering Logos	92
■ Product Settings	98
Changing the Session	98
Starting YaST	98
Resolution settings	99
Changing DisplayLanguage	100
Power button settings	100
Time settings	101
Auto-mount settings	101
■ Attaching the Connector Cover	102
■ Removing the Connector Cover	103
■ Attaching the Power Button Cover	104

Preinstalled OS Information..... 105

■ openSUSE	105
Preinstallation information	105
Recovery	106

Utility..... 109

■ EPSON TMNet WebConfig	109
Starting EPSON TMNet WebConfig	109
Information - Web serv settings - Current status	110
Information - System settings - Network	111
Information - System settings - Date Time	113
Settings - Web serv settings - Startup settings	114
Settings - Web serv settings - Printer	115
Settings - Web serv settings - Display	116
Settings - Web serv settings - Key input device	117
Settings - Web serv settings - Serial communications	118
Settings - Web serv settings - Other	119
Settings - Web serv settings - Register/delete	120
Settings - Web serv settings - Update settings	121
Settings - System settings - TCP/IP (Wired)	122
Settings - System settings - Wireless Setting	123
Settings - System settings - TCP/IP (Wireless)	124
Settings - System settings - Time Setting	125
Settings - Admin settings - Save/restore settings	126
Settings - Admin settings - Initialization	129
Settings - Admin settings - Log	130
Settings - Admin settings - Update Web service function	131
Settings - Admin settings - Admin information	132
Settings - Admin settings - Password	133

■ TM-T70II Utility	134
---------------------------------	-----

Application Development Information..... 135

■ Development Information for Each System	135
Download	135
■ PC-POS System Development Information	136
Interfaces and External Devices	136
Linux command control	137
Control Method for Devices	138
ESC/POS command	139
■ ePOS-Device API	144
External Devices.....	144
Application Information	146
■ ePOS-Device XML	147
External Devices.....	147
Application Information	149
■ Setting/Checking Modes	150
Self-test Mode	151
Hexadecimal Dumping Mode	152
NV Graphics Print Mode	153
Receipt Enhancement Information Print Mode.....	154
Memory Switch Setting Mode.....	155

Handling 157 |

■ Turning the Power On/Off	157
Turning the Power On	157
Turning the Power Off	157
Forced Termination.....	157
■ Printer Operation	158
Printer Reset.....	158
Setting and Replacing Roll Paper.....	158
Removing Jammed Paper	160
■ Adjusting the Speaker Volume	160
■ Cleaning the Case	160
■ Cleaning the Thermal Head	161
■ Connecting to External Devices	162
■ Preparing for Transport	163

Appendix 165

■ Character Code Tables 165

Common to All Pages.....	165
Page 0 (PC437: USA, Standard Europe).....	166
Page 1 (Katakana).....	167
Page 2 (PC850: Multilingual).....	168
Page 3 (PC860: Portuguese).....	169
Page 4 (PC863: Canadian-French).....	170
Page 5 (PC865: Nordic).....	171
Page 11 (PC851: Greek).....	172
Page 12 (PC853: Turkish).....	173
Page 13 (PC857: Turkish).....	174
Page 14 (PC737: Greek).....	175
Page 15 (ISO8859-7: Greek).....	176
Page 16 (WPC1252).....	177
Page 17 (PC866: Cyrillic #2).....	178
Page 18 (PC852: Latin2).....	179
Page 19 (PC858: Euro).....	180
Page 20 (KU42: Thai).....	181
Page 21 (TIS11: Thai).....	182
Page 26 (TIS18: Thai).....	183
Page 30 (TCVN-3: Vietnamese).....	184
Page 31 (TCVN-3: Vietnamese).....	185
Page 32 (PC720: Arabic).....	186
Page 33 (WPC775: Baltic Rim).....	187
Page 34 (PC855: Cyrillic).....	188
Page 35 (PC861: Icelandic).....	189
Page 36 (PC862: Hebrew).....	190
Page 37 (PC864: Arabic).....	191
Page 38 (PC869: Greek).....	192
Page 39 (ISO8859-2: Latin2).....	193
Page 40 (ISO8859-15: Latin9).....	194
Page 41 (PC1098: Farsi).....	195
Page 42 (PC1118: Lithuanian).....	196
Page 43 (PC1119: Lithuanian).....	197
Page 44 (PC1125: Ukrainian).....	198
Page 45 (WPC1250: Latin 2).....	199
Page 46 (WPC1251: Cyrillic).....	200
Page 47 (WPC1253: Greek).....	201
Page 48 (WPC1254: Turkish).....	202
Page 49 (WPC1255: Hebrew).....	203
Page 50 (WPC1256: Arabic).....	204
Page 51 (WPC1257: Baltic Rim).....	205
Page 52 (WPC1258: Vietnamese).....	206
Page 53 (KZ1048: Kazakhstan).....	207
Page 255 (User-Defined Page).....	208
International Character Sets.....	209

Product Overview

This chapter describes features and specifications of the product.

Features

The TM-T70II-DT is a highly-functional printer that has an auxiliary storage and a Linux controller in the thermal receipt printer TM-T70II. It can control POS peripherals such as customer displays, TM printers, and barcode scanners. The following is its features.

- Integrated thermal receipt printer TM-T70II and controller.
- The controller has the PC architecture that uses Intel[®] Atom processor.
- The OS employs Linux[®] based on openSUSE, and provides functionality as a Linux PC.
- You can connect external devices with USB connections and serial connections (LCD unit with touch panel, keyboard, MSR, etc.).
- Built-in Serial ATA storage device (SSD). You can use it with POS applications or databases.
- Equipped with 10BASE-T / 100BASE-TX / 1000BASE-T LAN communication capability as standard. As an optional feature, it can also support wireless LAN.
- You can print directly or control POS peripherals from the Web application. (ePOS-Device API).
- You can deploy and execute Web applications using server-side scripting (Perl or php) on the Apache HTTP server of this product.
- If Web contents are placed on this product's Web server, you can periodically acquire the contents from a separate server. (Automatic update of Web content)
- You can print directly and control POS peripheral equipment from a native application of iOS, Android or similar system. (ePOS-Device XML)
- You can use the pre-installed software required for the Thin-Client environment as the virtual desktop / application client and printer.

Features of this printer

- High speed printing (250 mm/s maximum) is possible.
- Multi-tone graphic printing is possible.
- Easy drop-in paper loading
- A maintenance counter function is supported.
- Paper-saving function is supported.

System connection examples

As shown below, you can configure various systems.

- PC-POS System ([Page 17](#))
- Printing and controlling POS peripherals from the Web application ([Page 18](#))
- Printing and controlling POS peripherals from an application on a tablet terminal ([Page 19](#))
- Virtual environment client ([Page 20](#))

PC-POS System

You can configure a simple POS system by installing POS applications and connecting a display with a touch panel and a barcode scanner to the TM-T70II-DT.

The OS is Linux based on openSUSE. This product includes SATA SSD. You can install the CUPS (Common Unix Printing System) driver and the JavaPOS driver.

You can also transfer the conventional Linux-based PC-POS system as it is.

This saves on system installation fees, saves space, and increases its maintainability.

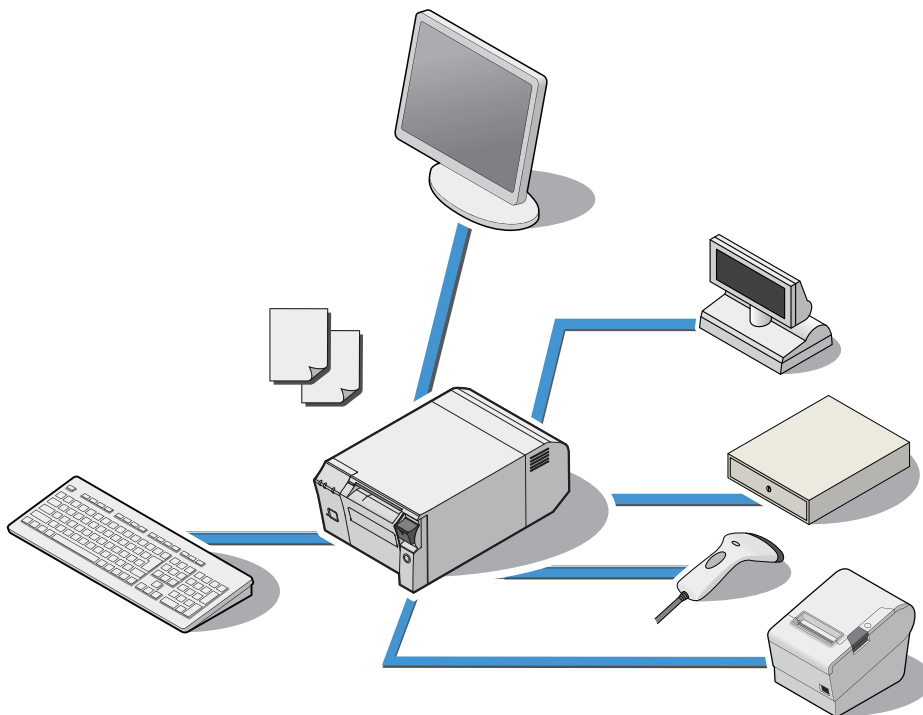

Printing and controlling POS peripherals from the Web application

ePOS-Device API is supported. You can print or control devices (display on the customer display or input/output from the POS peripherals) from the Web application.

You can control the customer display, barcode scanner, USB devices, or the serial device from the same API system. Also, you can customize the API and send and receive device commands.

You can control it from the Web browser on a computer, smart phone or tablet terminal.

- Connection example 1

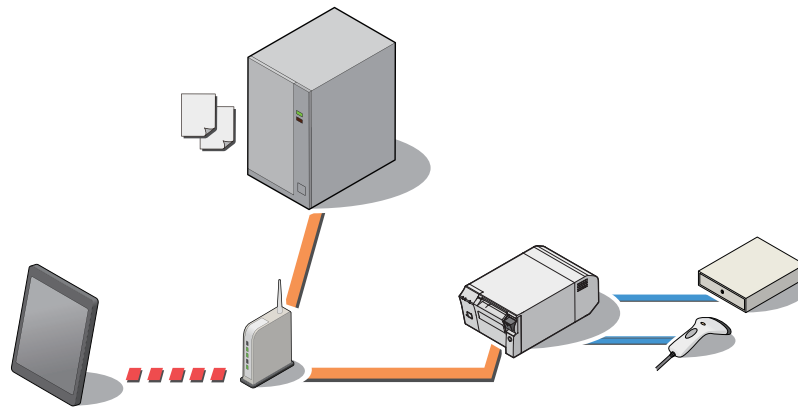

- Connection example 2

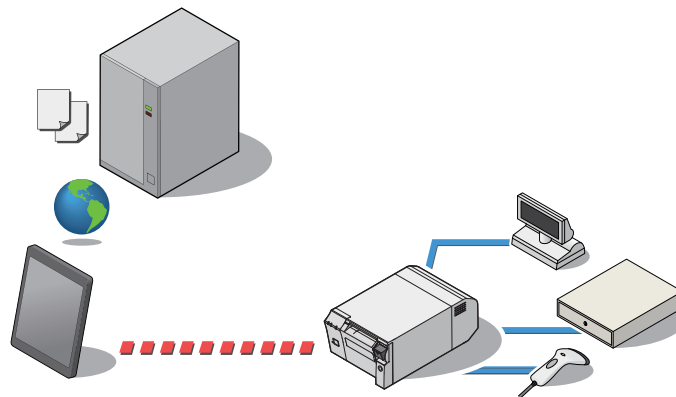

- Connection example 3

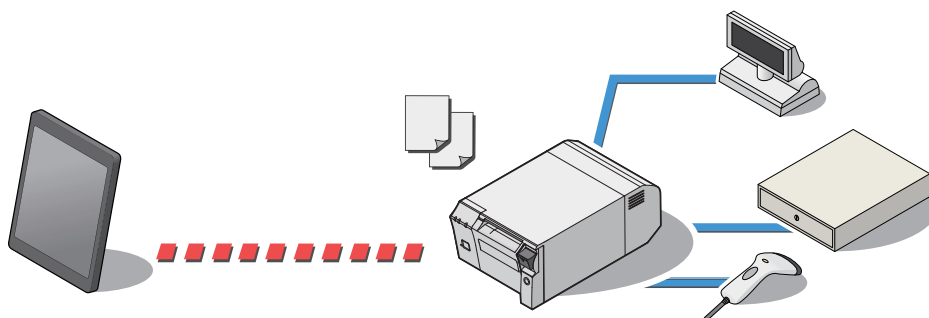

Printing and controlling POS peripherals from an application on a tablet terminal

ePOS-Device XML is supported. You can print or control devices (display on the customer display or input / output from the POS peripherals) from a tablet terminal application. You can control the customer display, barcode scanner, USB devices or serial devices from the same system.

Also, you can customize it and send and receive device commands. You can control it from the application on a smart phone or tablet terminal with socket communication.

If your environment allows for TCP socket communication, you can control it from your OS's native application.

- Connection example 1

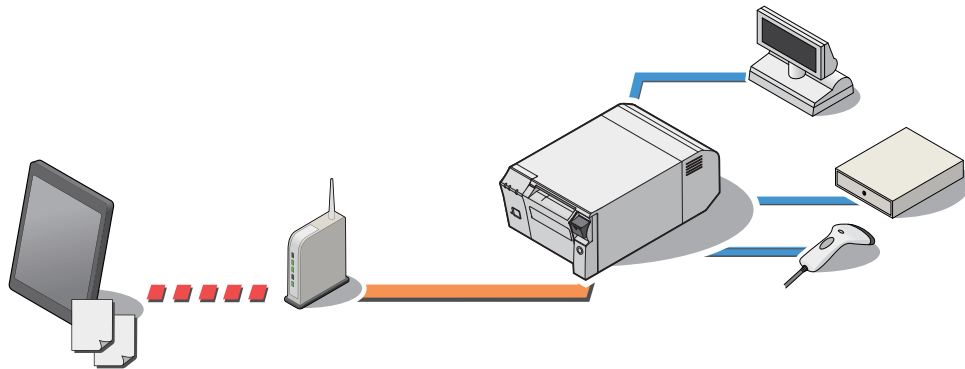

- Connection example 2

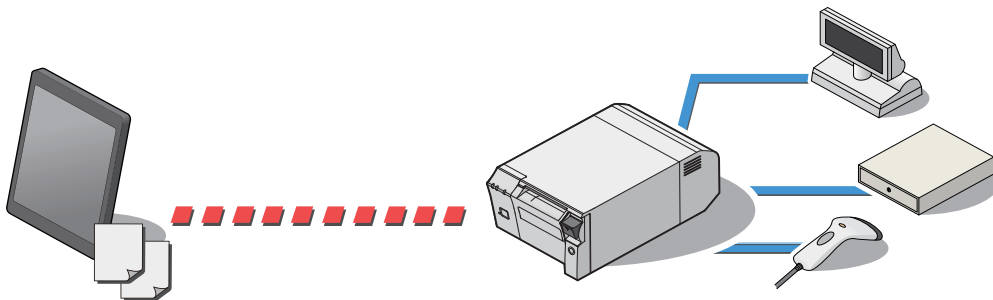

Virtual environment client

You can use the product as a client of a virtual desktop or virtual application.

It supports Citrix XenServer/Client.

Printing is supported for applications that use the JavaPOS driver and CUPS driver.

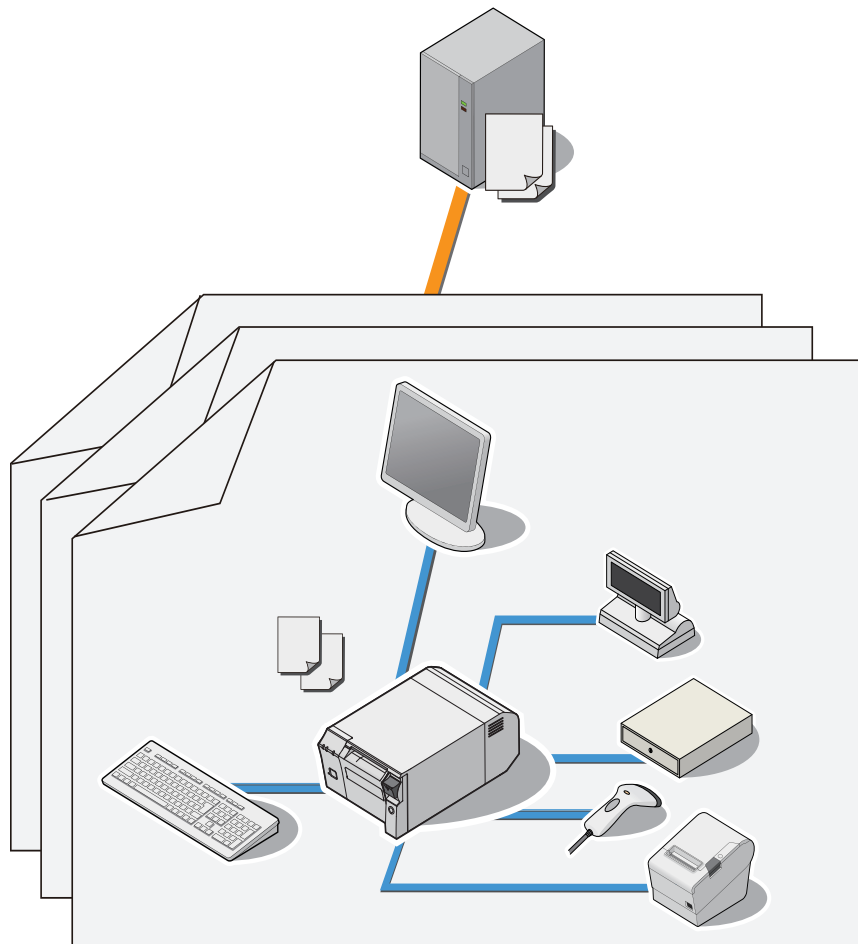

Product Configurations

Models

The following models are prepared for this product. The model varies depending on the region for sale.

CPU	Main memory	Auxiliary storage
Intel® Atom™ Processor N2600 1.6GHz	2GB	SATA SSD(16GB)

Paper width

- 80 mm

Colors

- Black

Accessories

Included

- AC adapter, T (Model No. M284A)
- AC cable *1
- Connector cover
- Roll paper (for operation check)
- Recovery disc
- Power button cover

*1 May vary based on specifications and region.

Options

- Wireless LAN cable set (Model: OT-WL01)
- Customer display (Model: DM-D110 (Dedicated Model))
- Affixing tape (Model: DF-10)

Related manuals

- TM-T70II-DT for Linux Technical Reference Guide (this manual)
- TM-T70II-DT User's Manual
- ePOS-Device API User's Manual
- ePOS-Device XML User's Manual
- TM-DT Linux Thin-Client System Setup Guide
- TM-DT series Easy Setup Guide

For details about each system, refer to ["Application Development Information" on page 135](#), or to each system manual.

Peripherals

The external devices that can be connected to this product, such as POS peripherals, vary based on the system in use. For details, refer to ["Application Development Information" on page 135](#).

Part Names and Functions

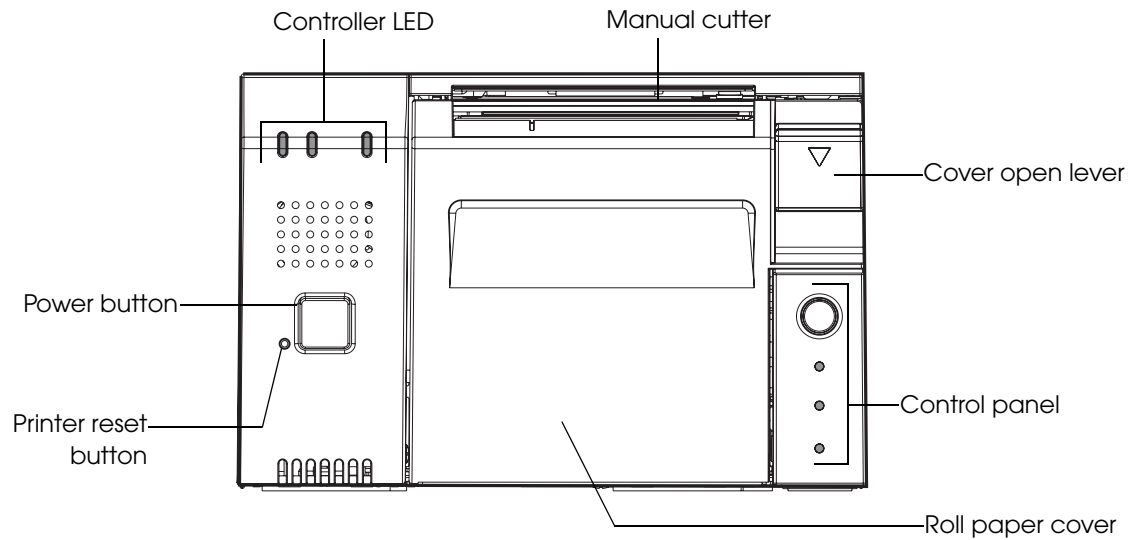

Name	Description
Power button	Turns the product on or off. Keep pressing the power button to turn off the product forcibly.
Printer reset button	Resets the printer unit. The controller unit is not reset.
Cover open lever	Opens the roll paper cover.
Controller LED	These display the controller unit's status.
Control panel	Feed button and indicator LEDs.
Roll paper cover	Open this cover to load/ replace the roll paper.
Manual cutter	A cutter for cutting the roll paper by hand.

Control Panel

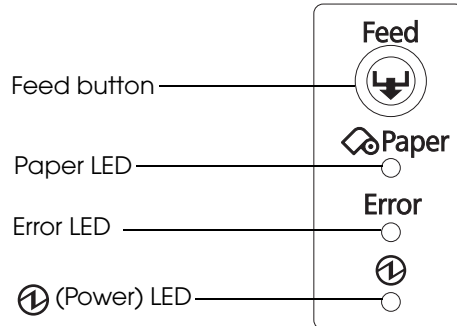

Name	Status	Description
Feed button		Pressing this button once feeds the roll paper by one line. Holding this button down feeds the roll paper continuously.
Paper LED	Off	There is a sufficient amount of roll paper remaining
	On	There is little or no roll paper remaining
	Flashing	A self-test printing standby state and macro execution standby state
Error LED	Off	Normal operation (online)
	On	<ul style="list-style-type: none"> Immediately after the power is turned on or immediately after a reset (offline). Automatically goes off after a while to indicate that the printer is ready. The end of the roll paper is detected, and when printing has stopped (offline). If this happens, replace the roll paper.
	Flashing	An error has occurred
⏻ (Power) LED	On	Power is being supplied
	Off	Power is not being supplied

Storage access LED and status LED

These display the controller unit's status.

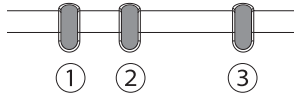

Name	Status	Description
① Status LED (green)	On	Power is on
	Flashing (Approx. 1 second intervals)	Stand-by mode
	Off	Power is off
② Status LED (orange)	Flashing (Approx. 1 second intervals)	OS start-up sequence <ul style="list-style-type: none"> • Accessing the SSD; Do not turn the power off. Doing so may result in data loss.
	Flashing (Approx. 160 millisecond intervals)	CPU high-temperature warning An error has occurred. Contact the Espon customer service.
③ Storage access LED (green)	On	Accessing the auxiliary storage

Connectors

All the cables are connected to the connection panel on the back of the printer.

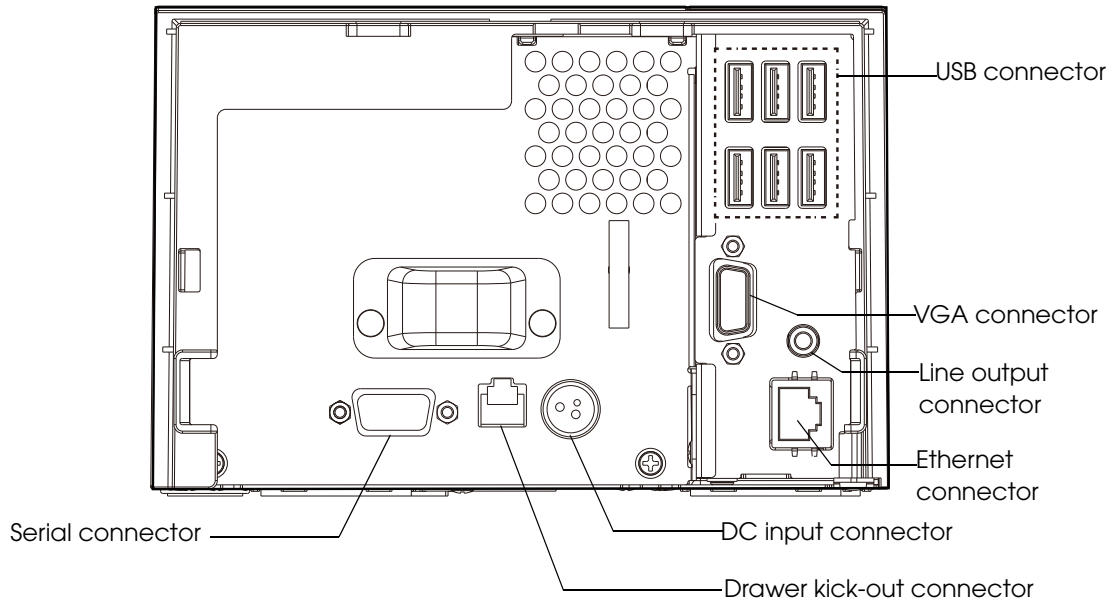

Name	Description
Drawer kick-out connector	Connect the cash drawer here.
Ethernet connector	Connect the printer to the network.
USB connector	Connect external devices with USB interface here.
DC Input connector	Connect the AC adapter T, here.
VGA connector	Connect the display here.
Serial connector	Connect a serial communication device with serial interface here.
Line output connector	Connect an external speaker here.

Printer function

Error Status

There are three possible error types: automatically recoverable errors, recoverable errors, and unrecoverable errors. Check the error LED flash code.

Automatically Recoverable Errors

Printing is no longer possible when automatically recoverable errors occur. They can be recovered easily, as described below.

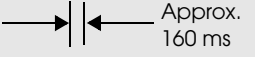
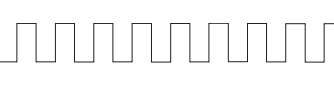
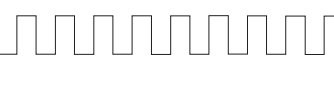
Error	Error description	Error LED flash code 	Recovery measure
Roll paper cover open error	The roll paper cover was opened during printing.		Recovers automatically when the roll paper cover is closed.
Print head temperature error	A high temperature outside the head drive operating range was detected.		Recovers automatically when the print head cools.

Recoverable Errors



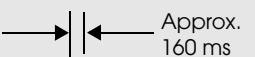
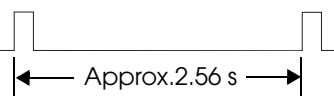

Printing is no longer possible when recoverable errors occur. The printer recovers easily by turning the power on again after eliminating the cause of the error.

Error	Error description	Error LED flash code 	Recovery measure
Autocutter error	Autocutter does not work correctly.		Remove the jammed paper or foreign matter in the printer, close the roll paper cover, and then turn the power on to recover.

Unrecoverable Errors

Printing is no longer possible when unrecoverable errors occur. The printer must be repaired.

 CAUTION	Turn off the power immediately when unrecoverable errors occur.
---	--

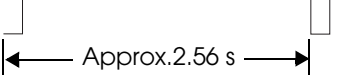
Error	Error description	Error LED flash code  Approx. 160 ms
Memory R/W error	After R/W checking, the printer does not work correctly.	
High voltage error	The power supply voltage is extremely high.	
Low voltage error	The power supply voltage is extremely low.	
CPU execution error	The CPU is executing an incorrect address.	
Internal circuit connection error	Internal circuits are not connected correctly.	

NV Memory (Non-Volatile Memory)

The printer's NV memory stores data even after the printer power is turned off. NV memory contains the following memory areas for the user:

- NV graphics memory
- User NV memory
- Memory switches
- R/E (Receipt Enhancement)
- User-defined page
- Maintenance counter



As a guide, NV memory rewriting should be 10 times or less a day when you program applications.

NV Graphics Memory

Graphics, such as shop logos to be printed on receipts, can be stored.

Use the TM-T70II Utility to register graphics.



- For detailed information about the TM-T70II Utility, see the TM-T70II Utility User's Manual.
- For information about how to use the NV graphics memory print mode, see ["NV Graphics Print Mode" on page 153](#).

User NV Memory

You can store and read text data for multiple purposes, such as for storing a note including customizing or maintenance information of the printer. Use ESC/POS commands to store and read the text data.



For information about ESC/POS commands, see the ESC/POS Command Reference.

Memory switches

With the memory switches, which are software switches for the printer, you can configure various settings of the printer. For information about the memory switches, see ["Setting the Memory Switches/Receipt Enhancement" on page 85](#).

R/E (Receipt Enhancement)

Graphics, such as shop logos to be printed on top or bottom of receipts can be registered. For information about R/E, see ["Setting the Memory Switches/Receipt Enhancement" on page 85](#).

User-defined Page

You can store character data in the user-defined page (character code table: page 255) so that you can also print characters not resident in the printer.

NOTE

- For the character code table, see ["Character Code Tables" on page 165](#).
- User-defined page is not supported by South Asia font models.

Maintenance Counter

With this function, printer information, such as the number of line feeds, the number of autocuts, and printer operation time after the printer starts working, is automatically stored in NV memory. You can read the information with the TM-T70II Utility or in a self-test to use it for periodical checks or part replacement.

NOTE

Maintenance Counter can be checked with the TM-T70II Utility or in a self-test.

Product Specifications

Item		Specifications
CPU	Usable CPU	Intel® Atom™ Processor N2600 (1MB Cache, 1.6 GHz)
Memory	Main memory	2 GB, DDR3-800, SO-DIMM slot
	BIOS	SPI Flash 4Mbyte
Chipset		Intel® NM10
Video controller		On built-in CPU
Auxiliary storage		SATA SSD (16GB)
Interface	Ethernet	10BASE-T/100BASE-TX/1000BASE-T 1port (RJ-45) Support Wake On LAN Network boot
	USB	External: USB 2.0 x 6 (supports high/full/low speed) Internal: USB 2.0 X 1 (for connecting to the printer)
	Serial	External x1 (9-pin DSUB male)
	VGA	External x1 (15-pin DSUB female)
	Drawer	External x1 (RJ12 6pin)
	Line output (Sound capability)	Outputs sound from internal speaker External x1 (line output)
RTC/CMOS backup battery		RTC is backed up by lithium primary battery
Speaker		Internal monaural speaker
Product's printer		Thermal receipt printer at 250 mm/s on 80-mm wide roll paper
Software	BIOS	AMI BIOS (Supports ACPI 2.0/APM 1.2/Plug&Play)
	OS	Linux® based on openSUSE
	Device control software	ePOS-Device Software required for connecting to Thin-Client
Power specifications (Dedicated AC adapter)		AC100V - AC240 V / 50 Hz - 60 Hz
Main unit power consumption		12.2W (when not printing) / Nominal value 54W (when printing)
External dimensions		172 mm {6.77"}(W) x 290 mm {11.42"}(D) x 114 mm {4.49"}(H) (inclusive of cable cover)
Case color		Black
Weight (Mass) (roll paper excluded)		2.8 kg {6.17 lb}

Power capacity to the exterior

Port	Power	Supply capacity
USB	DC 5V	500 mA each
Drawer	DC 24V	1A

Software Specifications

Print control	ePOS-Device API, ePOS-Device XML (No printer driver is required.)
TM Printer, POS peripherals control driver	<ul style="list-style-type: none"> • CUPS(Common Unix Printing System) driver • JavaPOS Version 1.13.9L
Web applications	Available server-side scripts: <ul style="list-style-type: none"> • PHP ver.5.3.15 • Perl ver.5.16.0 SQLite database access with the server-side script is also available
Utility	EPSON TMNet WebConfig <ul style="list-style-type: none"> • Registration of devices controlled by ePOS-Device • Registration settings for Web content • Various administrator function
Controllable printer	<ul style="list-style-type: none"> • Following printers with the UB-E02, UB-E03 or UB-R03 embedded <ul style="list-style-type: none"> * TM-T88V * TM-T70 * TM-T70II * TM-T90 * TM-L90
Number of printers	20 printers at maximum

Printing Specifications

Printing method	Thermal line printing	
Cutting method	Partial cut (cutting one point in left edge left uncut)	
Dot density	180 × 180 dpi	
Printing direction	Unidirectional with friction feed (Reverse feed is not supported.)	
Printing width	72.2 mm (2.84"), 512 dots	
Characters per line	Font A (12 × 24)	42
	Font B (9 × 17)	56
Maximum print speed* ¹	250 mm/s	
Line spacing	4.23 mm {1/5"} (Initial setting)	
Character spacing	0.28 mm {0.0110"} (2 dots)	

dpi: dots per inch

*1: When printing with the default print density level at 24V and 25°C {77°F}.

NOTE

Printing speed may be slower, depending on the such items as the data transmission speed.

Character Specifications

Number of characters	Font A (initial setting)	Alphanumeric characters: 95 Extended graphics: 128 × 43 pages (including user-defined page) International characters: 18 sets
	Font B	
Character structure	Font A (initial setting)	12 × 24 (including 2-dot horizontal spacing)
	Font B	9 × 17 (including 2-dot horizontal spacing)
Character size	Font A	Standard: 1.41 × 3.39 mm Double-height: 1.41 × 6.77 mm Double-width: 2.82 × 3.39 mm Double-width, double-height: 2.82 × 6.77 mm
	Font B	Standard: 0.99 × 2.40 mm Double-height: 0.99 × 4.80 mm Double-width: 1.98 × 2.40 mm Double-width, double-height: 1.98 × 4.80 mm
Characterh per line Standard/Double-height/ Double-width/Double-width, double-height(mm)	Font A	42/42/21/21
	Font B	56/56/28/28

NOTE

Space between characters is not included. Characters can be scaled up to 64 times as large as the standard size.

Printable Area

The printable area of paper with a width of 79.5 ± 0.5 mm { 3.13 ± 0.02 "} is 72.2 ± 0.2 mm { 2.84 ± 0.008 "} (512 dots), and the space on the right and left sides is approximately 3.7 mm {0.15"}.

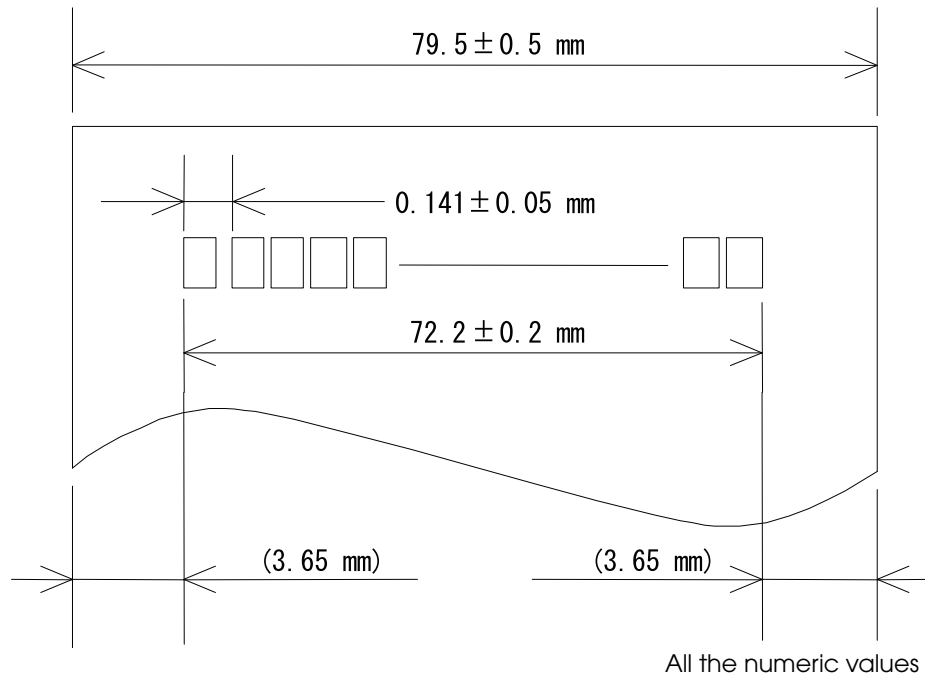

CAUTION

- In 2-divided energizing, the print position within the printable area of the thermal elements for dots 1 to 256 and 257 to 512 is shifted approximately 0.07 mm {0.0028"} in the paper feed direction as shown in the figure below.



Printing and Cutting Positions

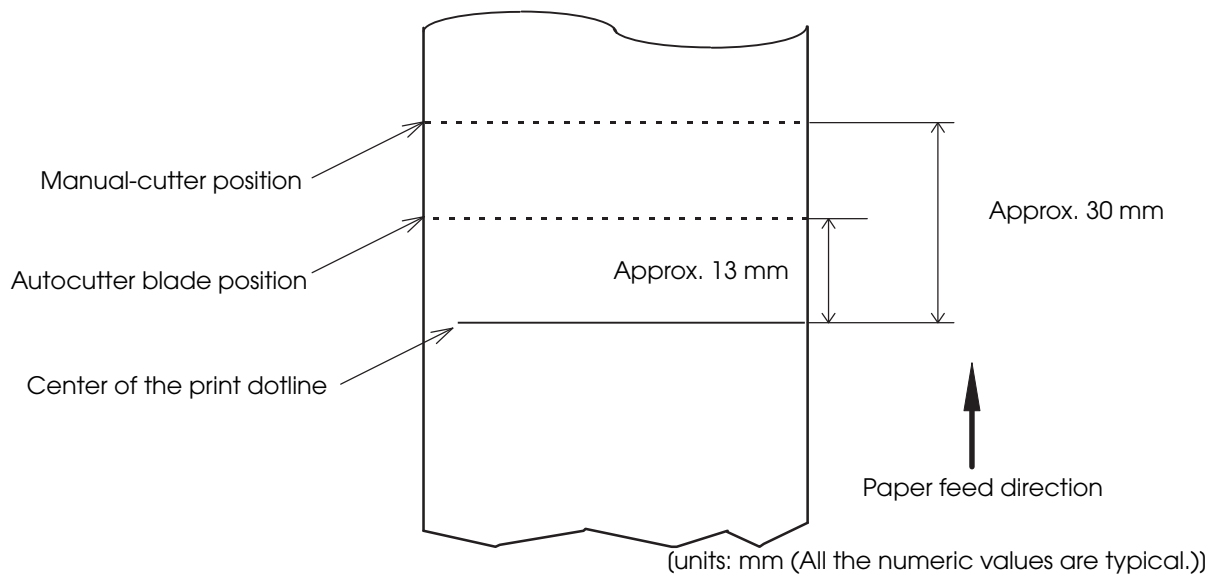

CAUTION

The values above may vary slightly as a result of paper slack or variations in the paper. Take this into account when setting the cutting position of the autocutter.

Paper Specifications

Paper types	Specified thermal paper	
Form	Roll paper	
Size	Roll paper diameter	83 mm {3.27"} maximum
	Roll paper core	Inside: 12 mm {0.47"}, Outside: 18 mm {0.71"}
	Roll width when taken up	80 + 0.5/-1.0 mm
	Paper width	79.5 ± 0.5 mm
Specified roll paper type	NTP080-80	
Specified original paper type	TF50KS-E, TF60KS-E (NIPPON Paper Industries Co., Ltd.) PD150R, PD160R, PD190R (OJI Paper Mfg. Co., Ltd.) P220AGB-1 (Mitsubishi Paper Mills Limited.) P300, P310, P350 (Kanzaki Specialty Papers) AF50KS-E (Jujo Thermal Oy) F5041 (Mitsubishi HiTec Paper Flensburg GmbH) KT55F20, KT48F20 (Koehler Paper Group)	

CAUTION

- Paper must not be pasted to the roll paper core.
- The remaining amount of the roll paper when a roll paper near-end is detected differs depending on the core type.
- For the best print quality for each paper type, it is recommended to set the print density. (See "[Setting the Memory Switches/Receipt Enhancement](#)" on page 85.)

Environmental Conditions

Temperature/ Humidity	Operating	5 to 40°C {41 to 113°F}, 10 to 90% RH (See the operating temperature and humidity range below.)
	Storage (Factory packing)	-10 to 50°C {14 to 122°F}, 10 to 90% RH (except for paper)
		<p>31°C, 90% 34°C, 90%</p> <p>34°C, 75% 40°C, 65%</p> <p>40°C, 43%</p> <p>Relative temperature (%RH)</p> <p>Operating environment range</p> <p>Environmental temperature (°C)</p> <p>----- Specified original paper: P300, P310, P350</p> <p>_____ Specified original paper other than above</p>
Acoustic noise (operating)		<p>Operating (max.): approximately 54 dB (Standing position)</p> <p>Standby (max.): approximately 42 dB (Standing position)</p> <p>Note:</p> <p>The values above are measured in the Epson evaluation condition.</p> <p>Acoustic noise differs depending on the paper used, printing contents, and the setting values, such as print speed or print density.</p>

External Dimensions

- Width: Approximately 172 mm {6.77"}
- Depth: Approximately 290 mm {11.42"}
- Height: Approximately 114 mm {4.49"}

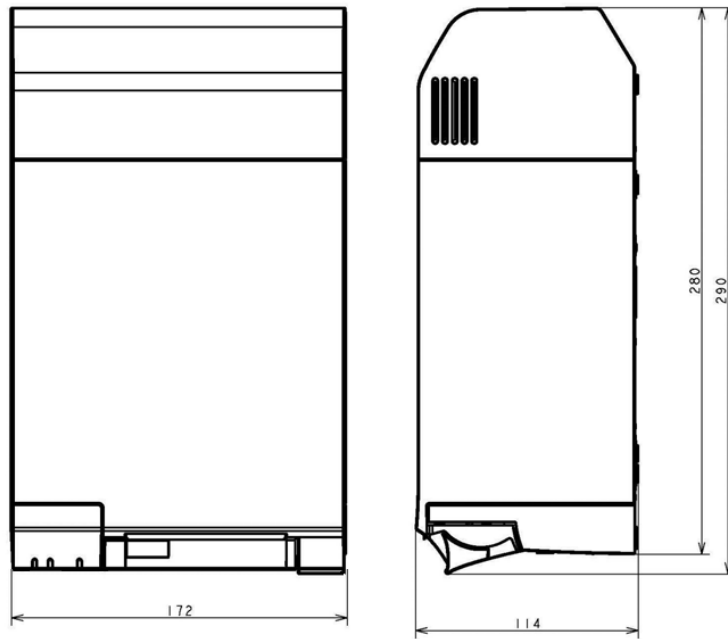

(Units: mm)

TM-T70II-DT Dedicated AC Adapter

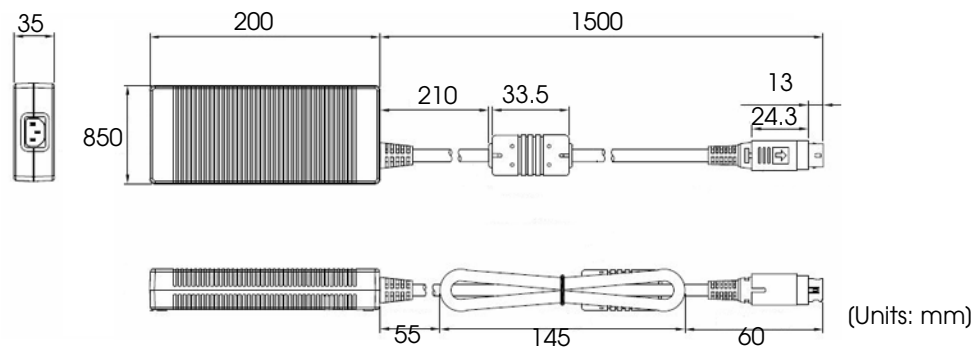

Input conditions	Input voltage: AC 100V to 240V
	Frequency: 50/60 Hz
	Input current (rating): 2.4A
Output conditions	Output voltage (rating): DC 24V \pm 5%
	Output current (rating): 4.2A

Option Specifications

Wireless LAN Cable Set (OT-WL01)

Wireless module	ELPAP07: 802.11b/g/n wireless LAN Module (EPSON)
Standard	IEEE802.11b/g/n (Wi-Fi certificated)
SSID	1 to 32 one-byte alphanumeric characters
Connection mode	Ad hoc mode, Infrastructure mode
Authentication method, Encryption algorithm	Open+WEP, Shared+WEP, WPA-PSK+TKIP, WPA-PSK+AES, WPA2-PSK+AES, WEP64, WEP128, TKIP, AES
Power voltage	DC 4.5V to 5.5V
Current consumption	300 mA at maximum
Frequency range	2.4 GHz band
Potential interference range	40 m
Overall dimensions	Wireless LAN unit: Approx. 24 mm × 51 mm × 10 mm (W × D × H) USB extension cable: 1 m long

Customer Display DM-D110 (Dedicated customer display)

Display format		Fluorescent tube display
Displayed number of characters		40 characters (20 columns x 2lines, 5 x 7 dot matrix)
Display color		Green (505 nm)
Brightness		690 cd/m ²
Types of characters		Alphanumeric characters: 95 characters International characters: 37 characters Graphic characters: 128 characters x 12 pages
Character construction		5 x 7 dot matrix, cursor
Character size		3.5 x 5.0 mm
Character pitch		5.2 mm
Interface	Standard	RS232C conformity
	Connector	USB2.0 Full-speed
Reliability		20000 houes (Half-brightness)
Power source (Voltage)		DC5V 0.5A (Maximum)
Power consumption		Approx. 2.5W
External dimensions	Display	165(W) x 50.5(D) x 69(H) mm
	Base	165(W) x 110(D) x63(H)mm
	Dimensions	165(W) x 110(D) x138(H)mm
Weight		0.67 kg {1.47 lb}
Color		White / Black
Tilt angle		Maximum 48°(4 steps, 5 position)
Morizontl rotation angle		Maximum 90°
Power supply		Supplied from TM-T70II-DT
Option		Pole unit (DP-105)

Setup

This chapter explains the installation and setting process for the product and external devices necessary before using this product and the setup for each system.

- PC-POS system ([page 44](#))
- ePOS-Device API ([page 45](#))
- ePOS-Device XML ([page 46](#))

Updating the ePOS-Device

Once you have updated the ePOS-Device, you can use the new ePOS-Device functions. For each system, refer to "[System connection examples](#)" on [page 17](#).

Confirming the ePOS-Device version

You can confirm the version of the ePOS-Device on the EPSON TMNet WebConfig title bar.

Downloading the ePOS-Device update program

Download the following file from the Epson website and save it in your local environment.

- File name: ePOS-Device System Update Package

For more information about the update method, refer to the Readme file in the ePOS-Device update package.

CAUTION

The ePOS-Device cannot be downgraded.

Flow of Setup

Setup for this product and the external devices vary depending on the system configuration method.

NOTE

In this setup flow, necessary items are in a frame with a solid line. Optional items are explained in a frame with a dotted line.

PC-POS System

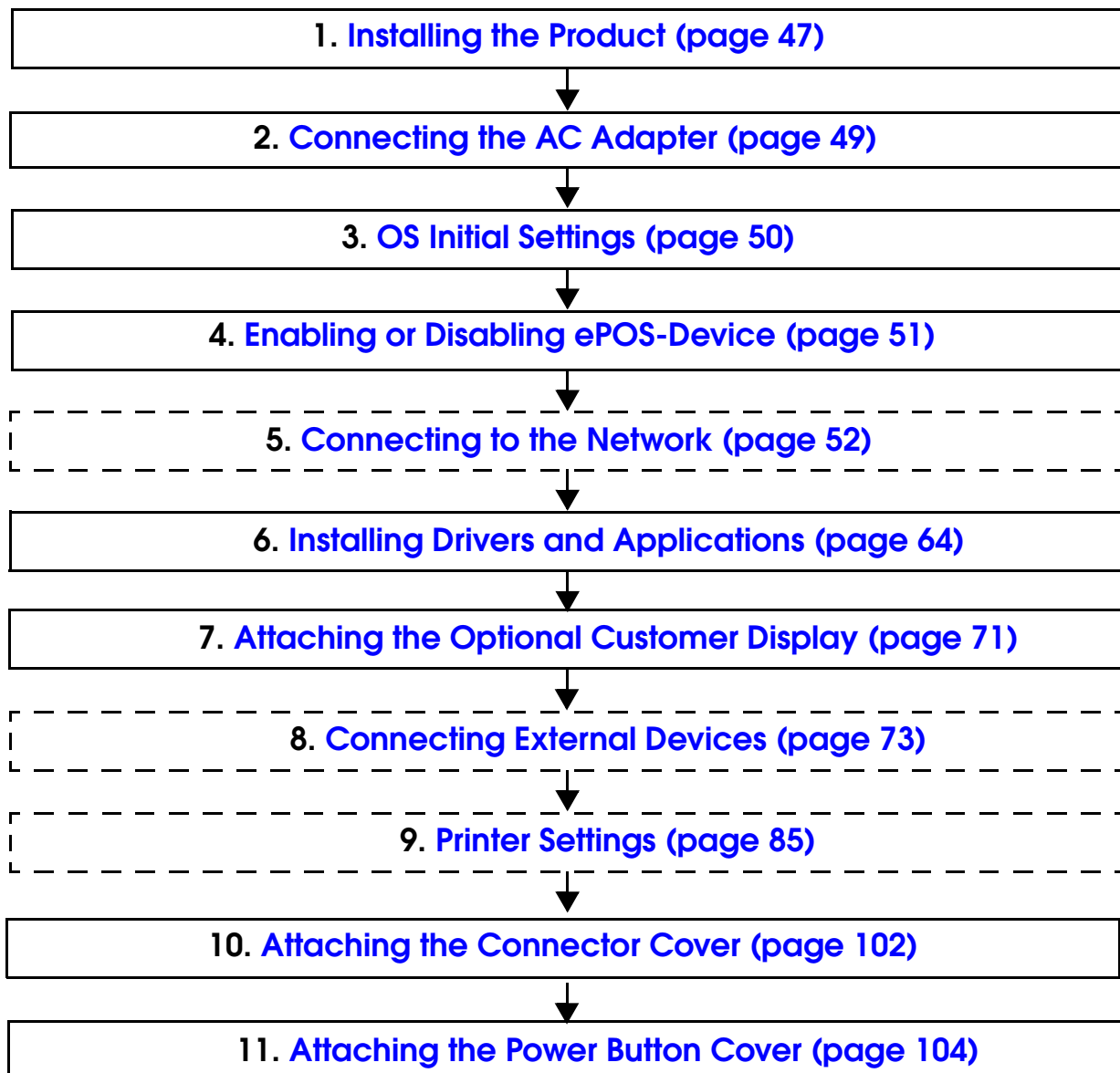

If using ePOS-Device API (Controlling the printing and external devices from a Web application)

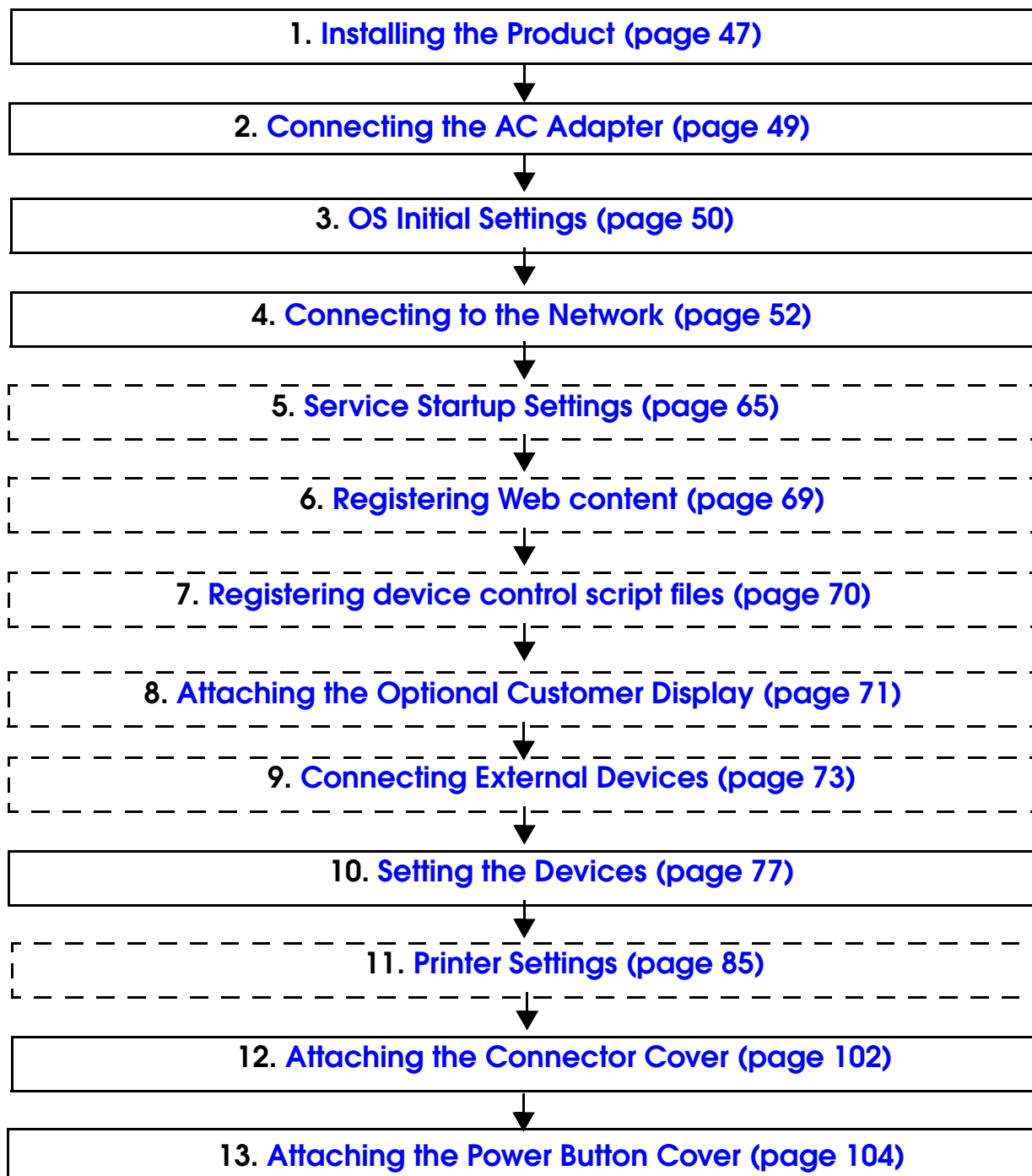

If using ePOS-Device XML (Controlling the printing and external devices from a terminal application)

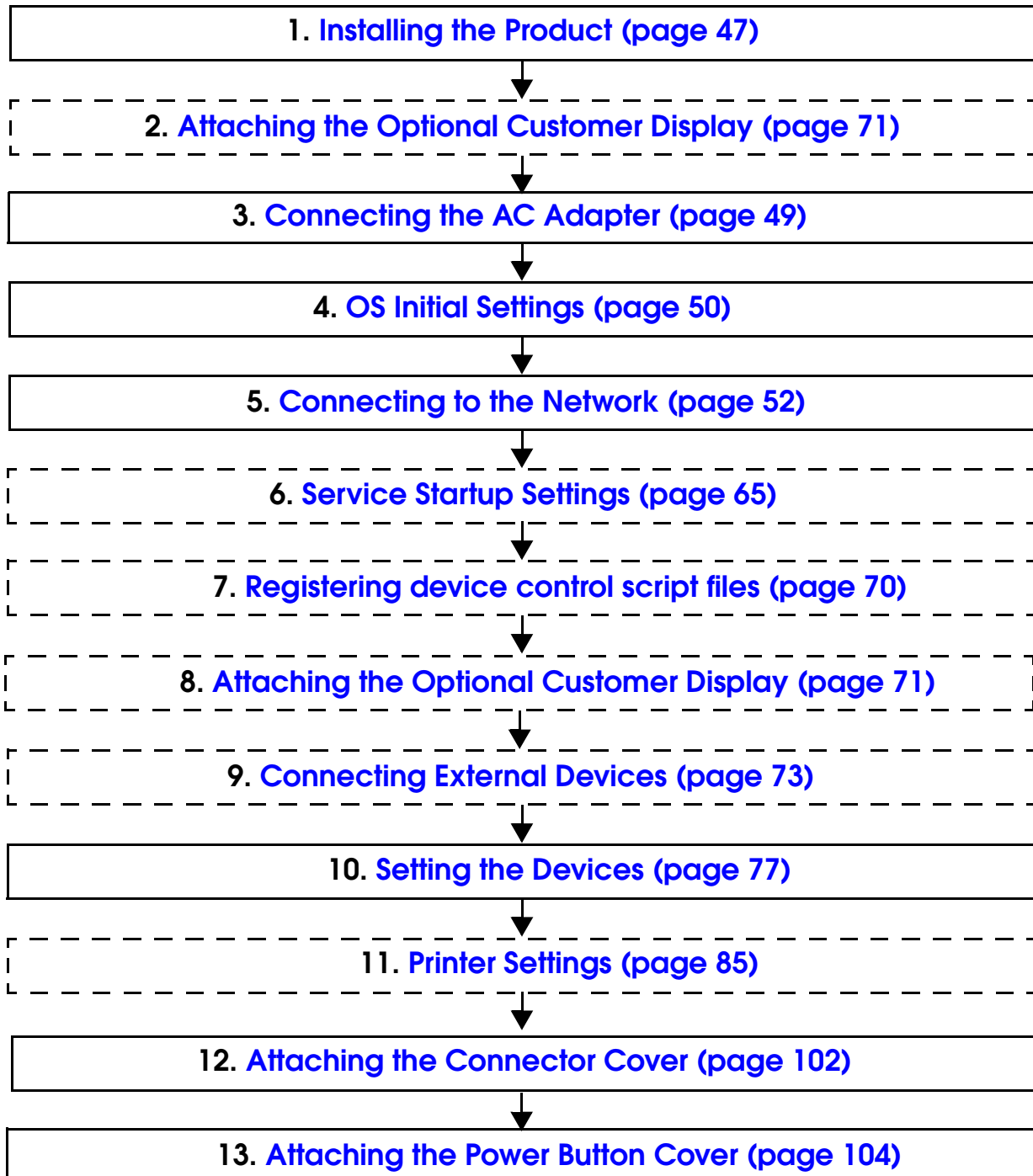

Installing the Product

You can install this printer only horizontally.

Fix the printer so that it does not move around when you open the roll paper cover and cut roll paper. A tape for fixing the printer is available as an option.

As shown in the figure below, install the printer with a maximum tilt of 3°.

Installing the printer with a tilt of more than 3° may cause the following problems.

- Roll paper near end cannot be detected.
- The roll paper cover will not close after installing roll paper.
- Roll paper cannot be taken out.

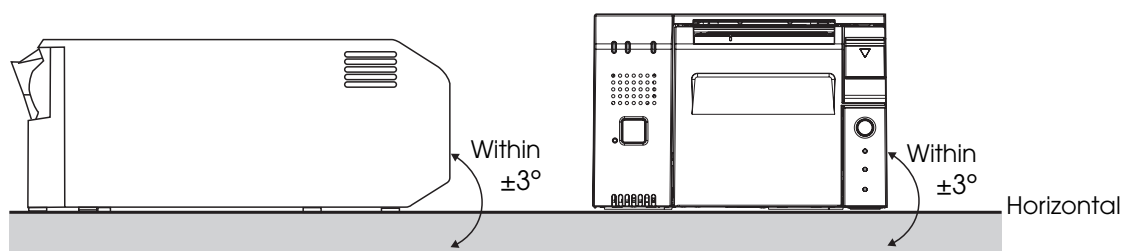

When you install the printer in an enclosed area such as a shelf, secure the following space between the printer and the shelf to avoid heat staying inside.

- Top: 15 mm or more
- Rear: 130 mm or more
- Sides: 50 mm or more (one side only)
- Front: open

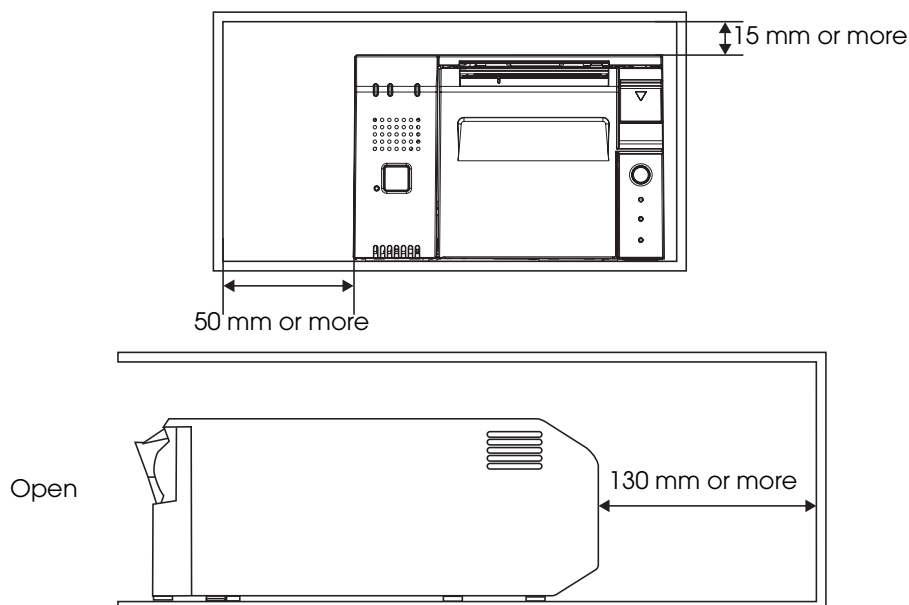

Important Notes

- The Product must be installed horizontally on a flat surface (not tilted).
- Firmly fix the printer so that it does not move when you open or close the roll paper cover or when the roll paper is cut.
- Do not place the printer in dusty locations.
- Do not knock or strike the Product. This may cause defective print.
- Do not catch cables and do not place foreign matter under the printer.
- Do not put anything that has a force of more than 32.7 N {3 kgf} on the top the printer.

Affixing Position of DF-10

When you use the affixing tapes for fixing the printer (Model: DF-10), paste them as shown in the figure below.

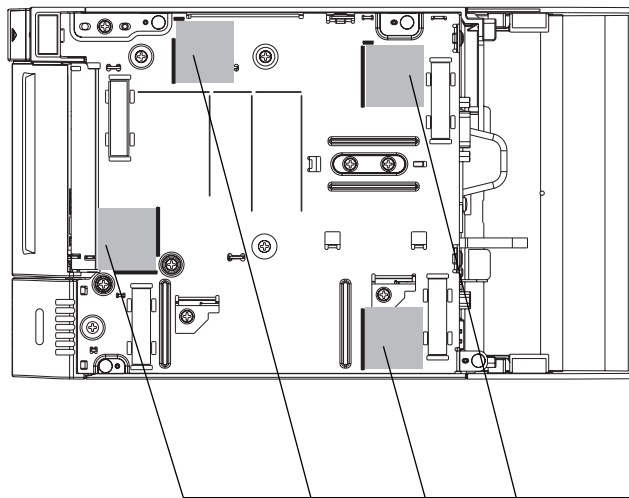

Affixing position of the DF-10

Connecting the AC Adapter

Use the dedicated AC adapter for TM-T70II-DT provided with the printer.



- **Be sure to use the included AC adapter as the power supply unit.** Using a nonstandard power supply can result in electric shock and fire.
- **Should a fault ever occur in the included AC adapter, immediately turn off the power to the printer and unplug the power supply cable from the wall socket.**

Connecting the AC adapter

- 1 Make sure that the power to the printer is turned off and that the AC adapter power cord is unplugged from the wall socket.
- 2 Insert the AC adapter power cord into the DC input connector for the printer.

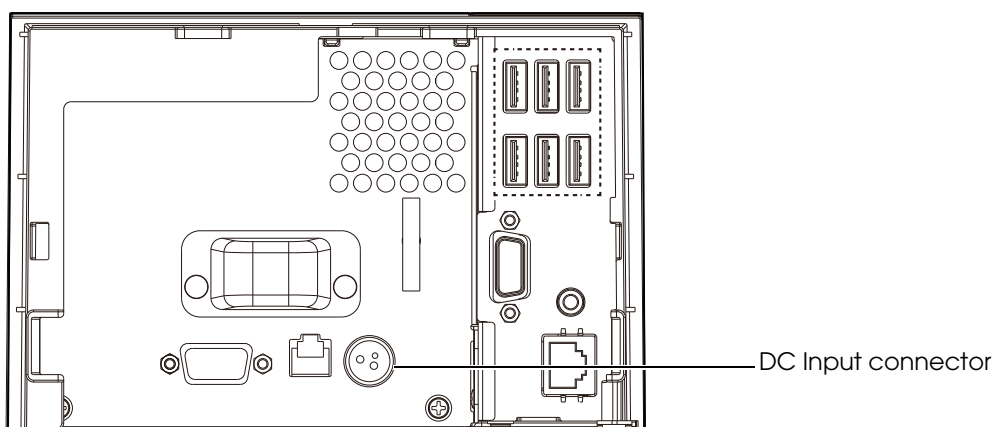

- **Be sure to unplug the power supply unit's cable from the wall socket whenever connecting or disconnecting the power supply unit to the printer.** Failure to do so may result in damage to the power supply unit or the product.
- **Make sure the wall socket power supply satisfies the rated voltage requirements of the power supply unit. Never insert the power supply cable plug into a socket that does not meet the rated voltage requirements of the power supply unit.** Doing so may result in damage to both the power supply and the product.



When you disconnect the dedicated DC cable connector for TM-T70II, make sure that the AC adapter power cord is unplugged, and hold the connector at the section marked with an arrow to pull it straight out.

- 3 Plug in the AC Adapter power cord to the wall socket.

OS Initial Settings

The following explains the procedures for setting the OS when you turn on the power for this product for the first time.

CAUTION

- When performing setup for the OS, you need a display and a keyboard and a mouse.
- Connect the display when this product is off.
If you connect the display when this product is on, data may not be properly displayed.

- 1** Check that the product's power is not on, and connect the display, a keyboard, and a mouse.
- 2** Turn on the product.
- 3** The items shown below, including this resolution information, are displayed as start options when the printer (main body) is started.

You can select from the following resolutions.

- openSUSE 640x480
- openSUSE 800x600
- openSUSE 1024x768
- openSUSE 1280x1024
- openSUSE 1600x1200
- openSUSE 12.2 (Failsafe)

NOTE

Select a resolution that is not supported by the display can result in a failure to display anything. If this occurs, restart this product and select an appropriate resolution.

- 4** The login screen is displayed. Input the password.
The initial settings are as follows.

User name	Password
EPSON-USER	TMDT

NOTE

You can change the session at the login screen. The setting at the time of factory shipment is [KDE Plasma Workspace]. Select [Menu] - [Session Type]. Select [GNOME] or [KDE Plasma Workspace] from the list.

- 5** The OS desktop is displayed. Set the time, date, and the timezone.

NOTE

You can also set the date, time, and the timezone using EPSON TMNet WebConfig.

Enabling or Disabling ePOS-Device

Use the desktop shortcut to enable or disable ePOS-Device.

Enable it if you are using ePOS-Device.

NOTE

- If you enabled ePOS-Device, it uses 100 MB or more of memory. If you are using this product with a PC-POS system or in a virtual environment, we recommend disabling e-POS-Device.
- ePOS-Device is set to [Enabled] in the default settings.

Enabling ePOS-Device

Run [Enabling ePOS-Device] from the shortcut on the desktop.

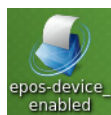

Disabling ePOS-Device

Run [Disabling ePOS-Device] from the shortcut on the desktop.

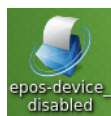

Connecting to the Network

For Ethernet Interface

Connect the product to a network by a LAN cable via a hub.

Connecting the Ethernet interface cable



- **When LAN cables are installed outdoors, make sure devices without proper surge protection are cushioned by being connected through devices that do have surge protection.**
Otherwise, the devices can be damaged by lightning.
- **Never attempt to connect the customer display cable, drawer kick-out cable, or a standard telephone line cable to the Ethernet connector.**

Insert a category 5e or higher LAN cable into the Ethernet connector until you hear a click.

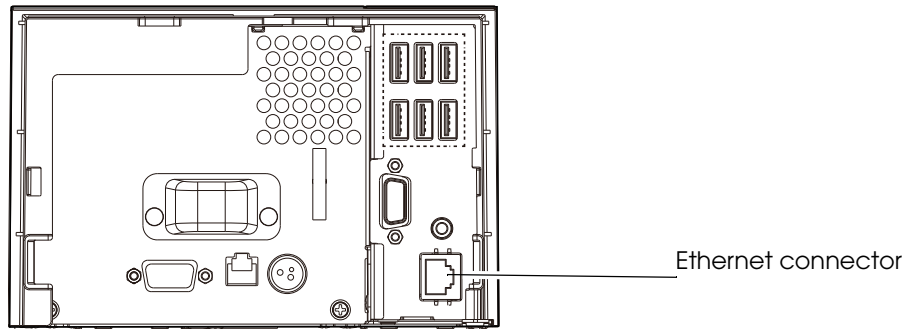

Network settings

Perform network settings, such as the IP address. These settings are the same as a Linux PC. You can perform settings in the following ways.

- Setting in a local environment: Setting with YaST
- Setting on web browser from remote/local PC: Setting with EPSON TMNet WebConfig

Setting with YaST

- 1 Start YaST.
- 2 Select (Network Devices) - (Network Settings).
- 3 The "Network Settings" screen is displayed. Select the device to set from the list of the (Overview) tab, then click (Edit).

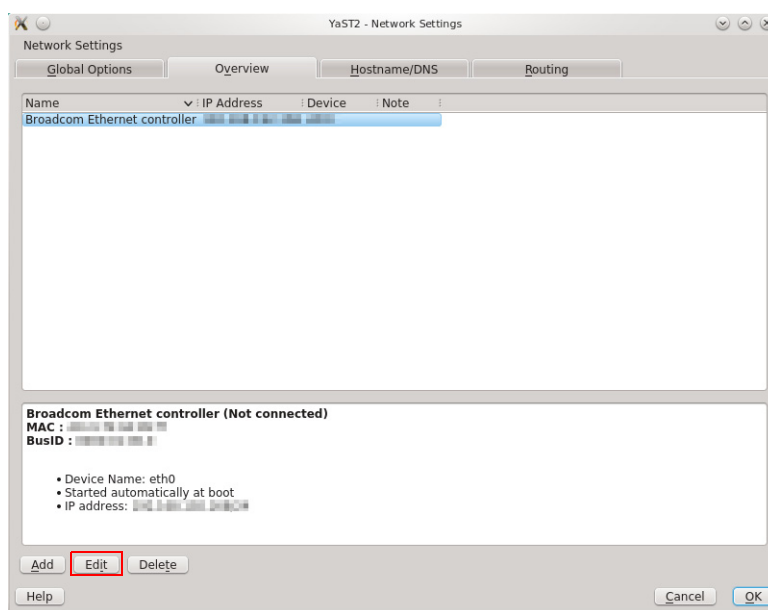

- 4 The "Network Card Setup" screen is displayed. Change the settings, then click (Next).

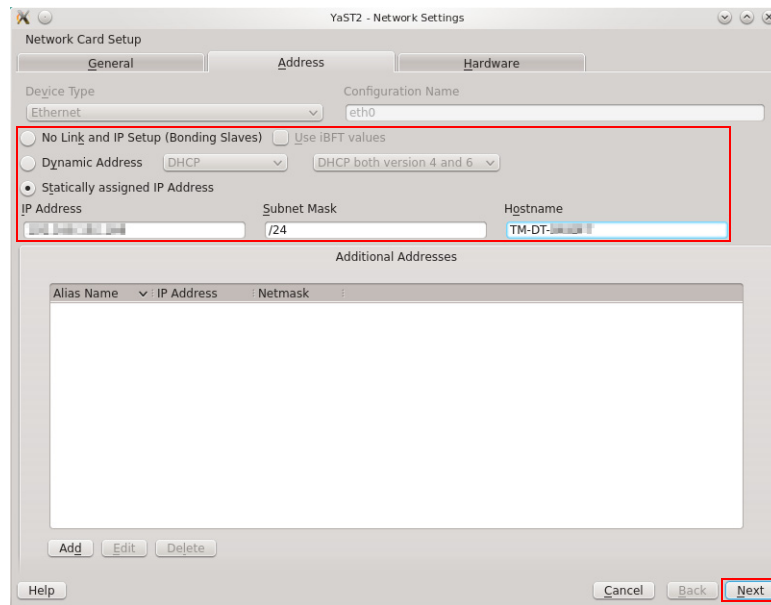

EPSON TMNet WebConfig

You can perform settings from a PC for settings via the network. You can also set the IP address without connecting a display to this product.

- 1 Start the Web browser of the PC for settings, and input the following.
<http://This product's IP address/webconfig/>
 EPSON TMNet WebConfig starts.
 The default IP address for this product is "192.168.192.168".
- 2 Select (Wired), then (TCP/IP).
 The "TCP/IP setting (Wired)" screen is displayed.

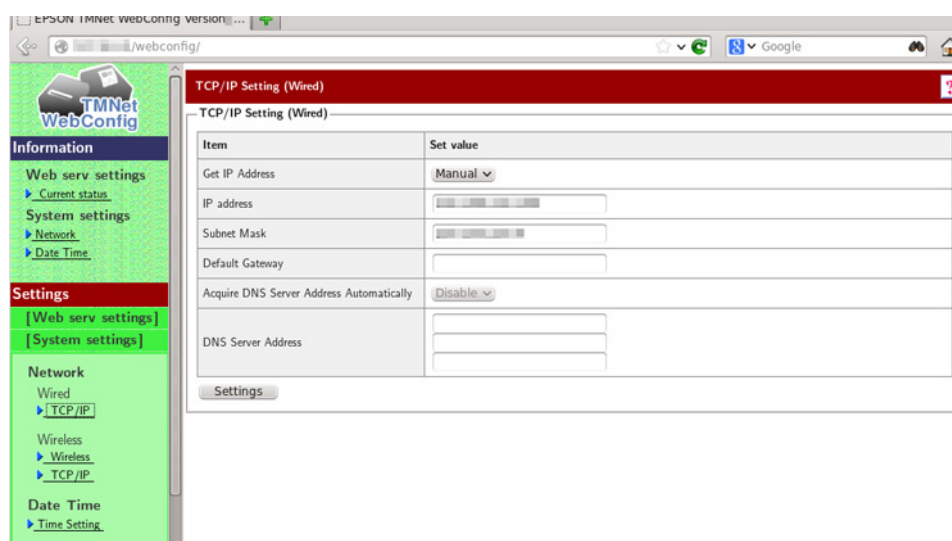

- 3 Set the IP address and other network settings, then click (Settings).

For Wireless LAN Interface

The optional wireless LAN cable set (OT-WL01) enables you to use the product with a wireless LAN connection.

Connecting the wireless LAN cable set

Check whether the following items are included. If any item is damaged, contact your dealer.

- Wireless LAN unit
- USB extension cable
- Affixing tape (1 pair, 2 pieces)
- Rubber cover
- User's manual

- 1** Attach the included rubber cover to the connector of the USB extension cable into which the wireless LAN unit will be inserted, to prevent the unit from coming off.

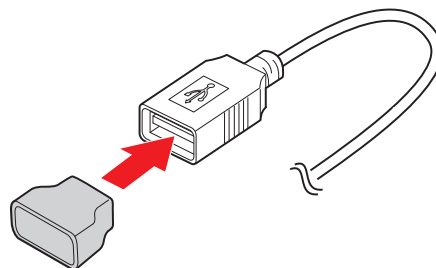

- 2** Insert the wireless LAN unit into the connector of the cable.

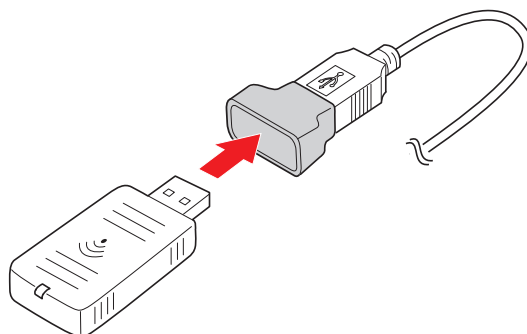

CAUTION

Adjust the position of the rubber cover so that the description on the label on the back side of the wireless LAN unit is not covered.

- 3** Connect the USB extension cable to the USB connector of the printer.

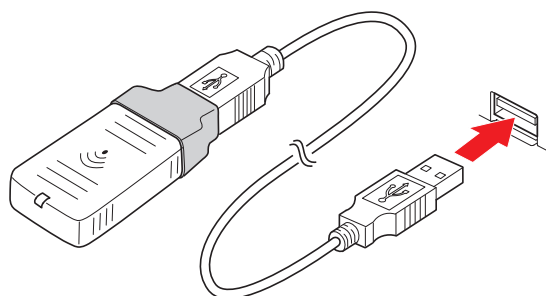
**NOTE**

If you want to fix the wireless LAN unit, cut the included affixing tape to fit and put on the unit, and fix the unit in a place with good communication.

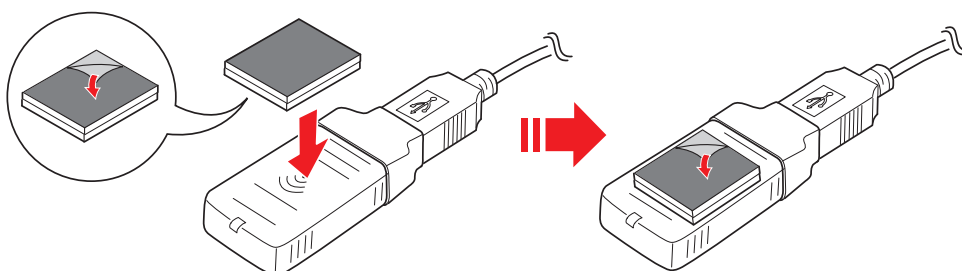

Wireless LAN indicator

The position of the wireless LAN indicator is shown in the illustration below.

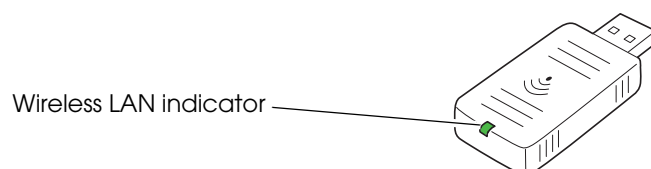

Wireless LAN indicator (Green)	Status
Off	The wireless LAN unit is not connected to the printer. Or the printer power is OFF.
Flashing	This wireless LAN unit is connected to the printer and is in operation.
Flashing rapidly	This wireless LAN unit is connected to the printer and is in operation. This unit is communicating on a network.

Network settings

Perform network settings, such as the IP address. These settings are the same as a Linux PC. You can perform settings in the following ways.

- Setting with YaST
- Setting with EPSON TMNet WebConfig

NOTE

- This product cannot use ad hoc mode and infrastructure mode at the same time.
- Perform network settings the devices you will connect to this product via ad hoc.

Setting with YaST

- 1** Start YaST.
(For details on starting YaST, refer to ["Starting YaST" on page 98.](#))
- 2** Select (Network Devices) - (Network Settings).
- 3** "Network Settings" screen is displayed. Click (Add) in (Overview) tab.

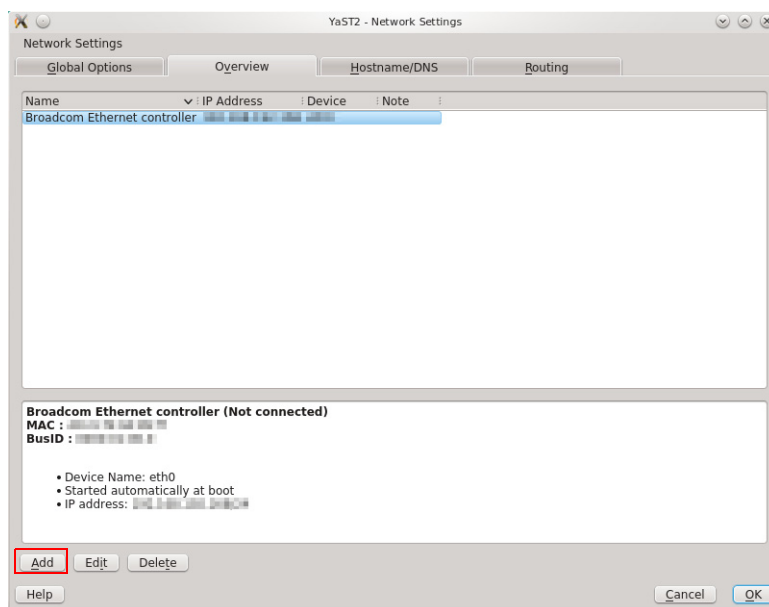

- 4 “Hardware Dialogue” screen is displayed. Set (Device Type) and (Module Name), then click (Next).

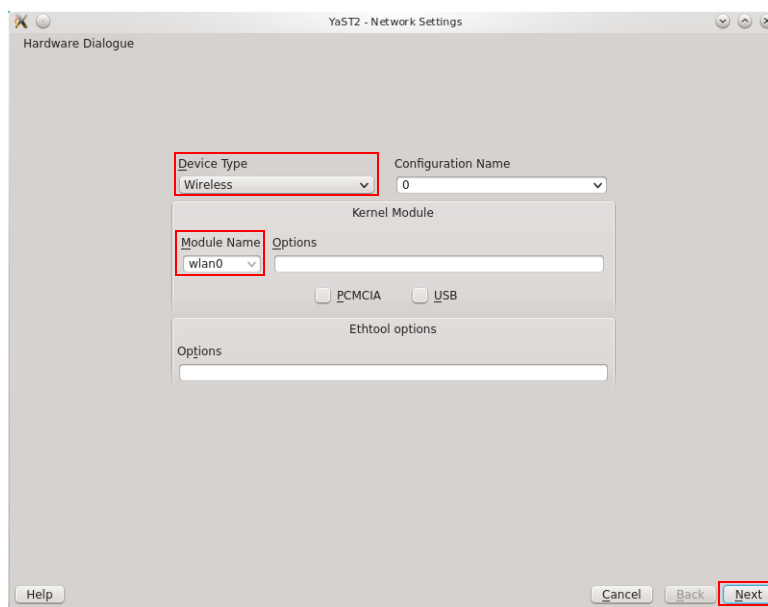

Item	Setting
Device Type	Select “Wireless” from pulldown menu.
Module Name	Input “wlan0”.

- 5 “Network Card Setup” screen is displayed. Select (Dynamic Address) or (Statically assigned IP Address).

When select (Dynamic Address)	Go to step 7.
When select (Statically assigned IP Address)	Go to step 8.

- 6 When Select (Dynamic Address), then set about dynamic address settings. Click (Next). Go to step 8.

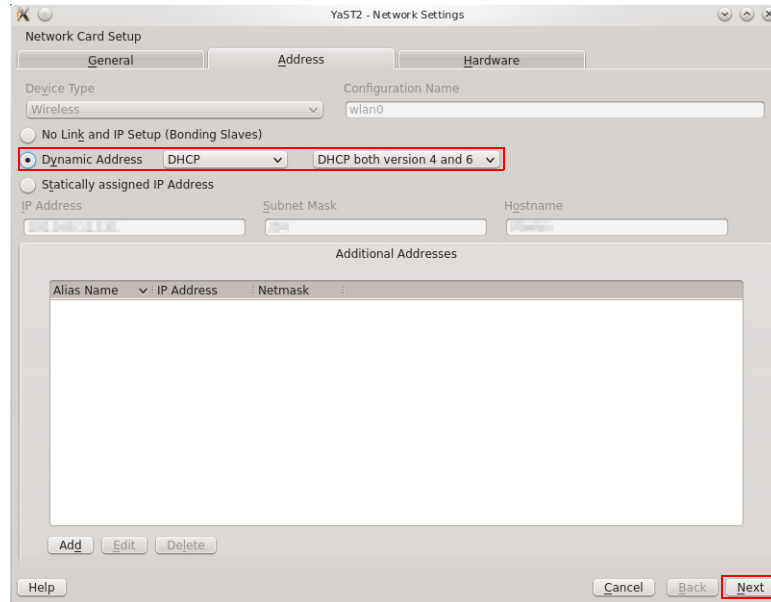

- 7 When Select (Statically assigned IP Address), then set (IP Address), (Subnet Mask), and (Hostname). Click (Next).Go to step 8.

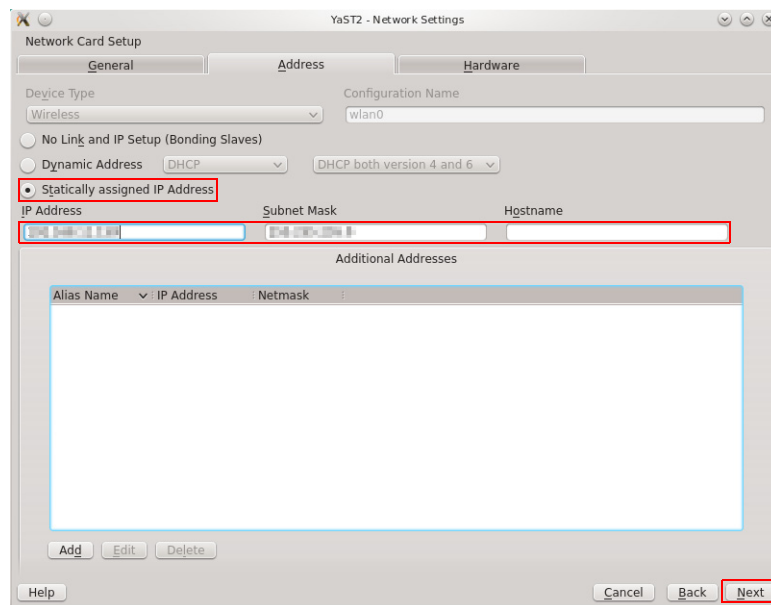

- 8 “Wireless Network Card Configuration” screen is displayed. After selecting (Operating Mode), specify the security settings. Click (Next).

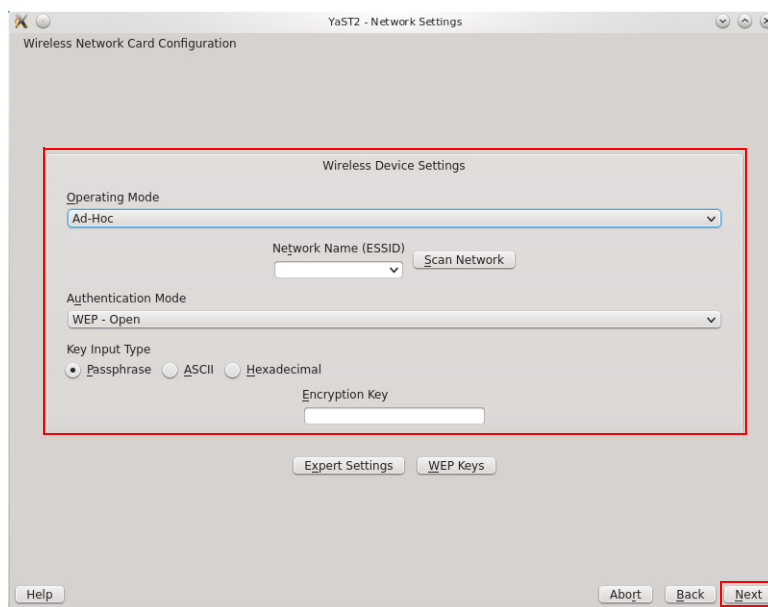

Item		Setting
Operating Mode	Ad-Hoc	Select if using Ad-Hoc Mode.
	Managed	Select if using Infrastructure Mode.
Network Name (ESSID)		Input the network ESSID. If the network has already been configured, click (Scan Network) to display the ESSID.
Authentication Mode		For specifying the security setting. Set in accordance with the network environment.

- 9 “Network Settings” screen is displayed.
The device added to the list in the (Overview) tab is displayed.
Click (OK).

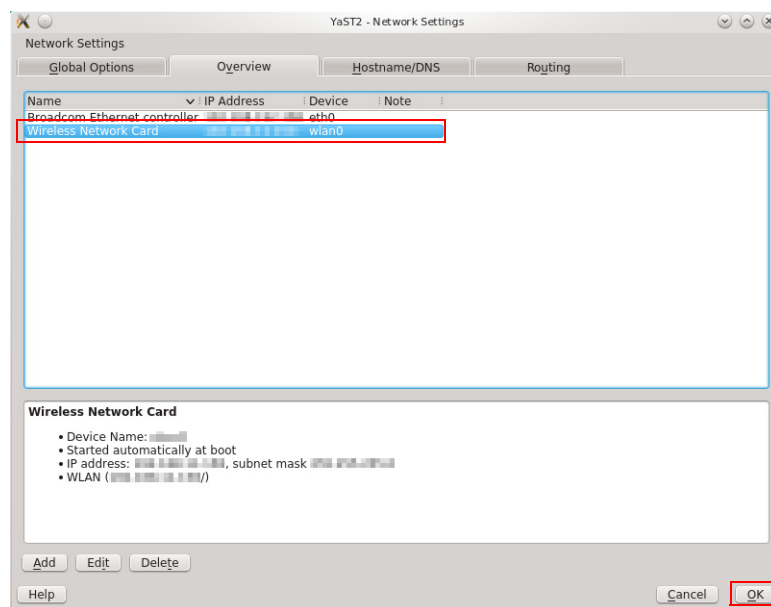

- 10 The following file is created if settings of a wireless LAN module are specified.
`/etc/sysconfig/network/ifcfg-wlan0`

- 11 Edit the ifcfg-wlan0 file. Open the file and edit as shown below.

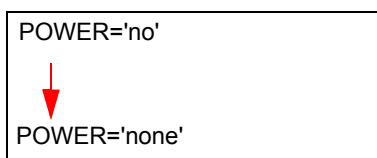

Setting with EPSON TMNet WebConfig

You can perform settings from a PC for settings via the network. You can also set the IP address without connecting a display to this product.

- 1 Start a Web browser of the PC for the settings, and input the following.
<http://This product's IP address/webconfig/>
 EPSON TMNet WebConfig starts.
 The default IP address for this product is "192.168.192.168".
- 2 Select (Wireless), then (Wireless).
 The "Wireless Settings" screen is displayed.

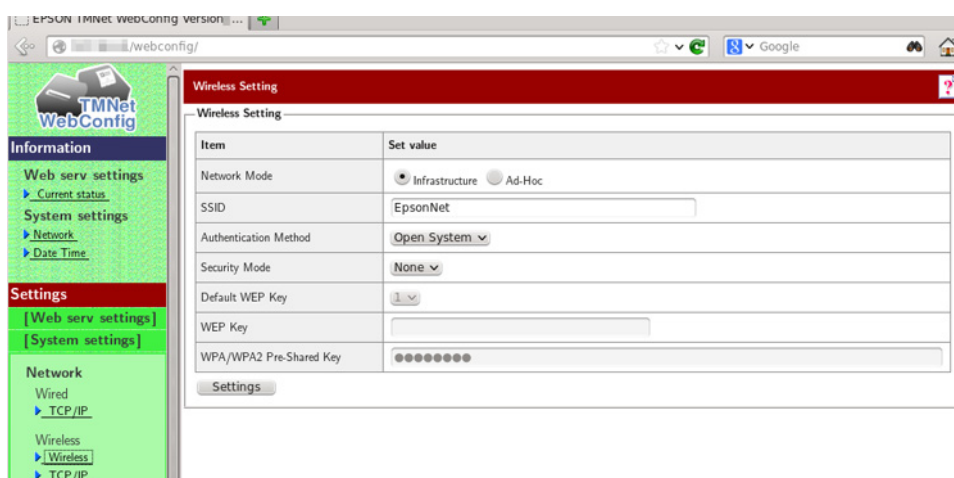

- 3 Perform network settings for a wireless LAN, then click (Settings).
- 4 Select (Wireless), then (TCP/IP).
 The "TCP/IP Settings (Wireless)" screen is displayed.

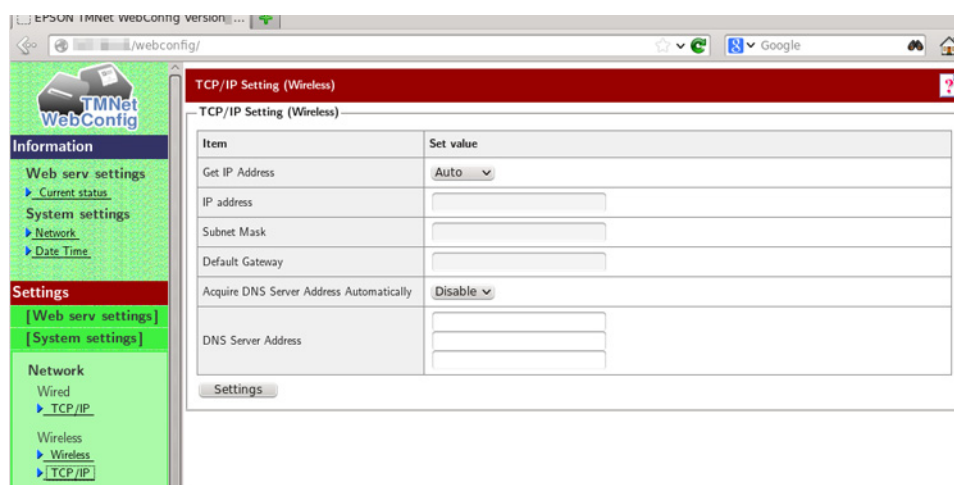

- 5 Set the IP address and other network settings, then click (Settings).

Installing Drivers and Applications

Installing the Drivers

You must install drivers depending on the type of external devices.

When you want to control an external TM printer with a printer driver, install CUPS driver.

For more about how to install and set the drivers, refer to the manual for each driver.

CAUTION

- Printer settings can not be specified at [Printer] of YaST but at CUPS. The CUPS access procedure is as follows.
Input the following in the browser address bar.
`http://localhost:631`
- CUPS driver is installed in this product. (factory default state)
The location of the installer is as follows.
`/opt/epson/tmt-cups/tmt-cups-1.4.2.0.tar.gz`
- The location of the CUPS manual is as follows.
`/opt/epson/tmt-cups/manual/...`
- The installers for JavaPOS ADK is included. Install them as necessary. The location of the installer is as follows.
`opt/epson/UPOSforDT/Epson_JavaPOS_ADK_11310.tar.gz`

NOTE

It is not necessary to install printer drivers for the models shown below. By specifying settings using CUPS, you can select the PPD file corresponding to the model. It is necessary to install printer drivers if adding any printers other than those listed below.

- TM-T20
- TM-T70II
- TM-T82
- TM-T82II
- TM-T88V

Installing Applications

Install the applications you want to use.

Service Startup Settings

It is necessary to perform service setup settings for the TM-T70II-DT depending on the system operation method.

Use EPSON TMNet WebConfig to perform the service setup settings, following the procedures below.

CAUTION

Items to be set differ depending on the versions of EPSON TMNet WebConfig.

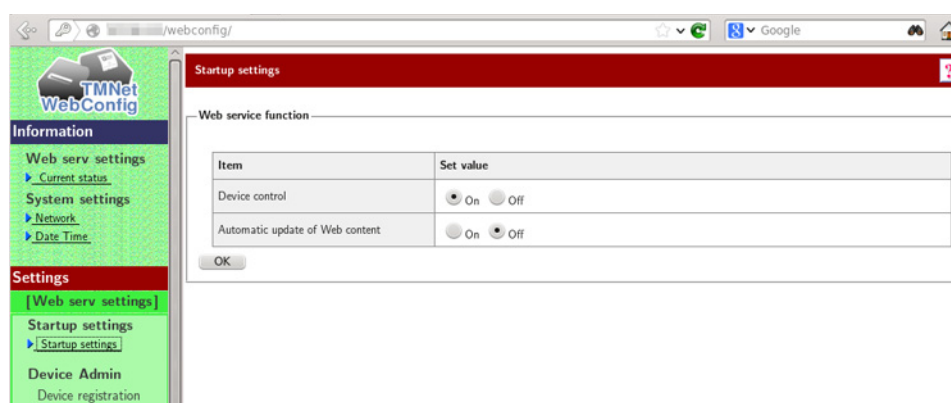

- 1 Start a Web browser of the PC for the settings, and input the following.
<http://This product's IP address/webconfig/>
 EPSON TMNet WebConfig starts.
- 2 Select (Web serv settings), then (Startup settings).
 The "Startup settings" screen is displayed.

3 Set the following, then click (OK).

Item	Description
Device control	Set whether to control POS peripherals using this product or not.
Automatic update of Web content	Set whether to use the automatic update for Web content or not.

Support system and startup settings for each service are as follows.

System	Device control	Automatic update of Web content
ePOS-Device API	Enabled (default)	Disable / Enable
ePOS-Device XML	Enabled (default)	Disable

Registering Web Contents

Perform registration as follows, depending on the system and method in use.

If placing Web content in this product's Web server using ePOS-Device API, register the Web content.

CAUTION

When you upload Web content, the existing registered Web content is discarded.
(The folders under U_data remain.)

Specifications of the file to be registered

- You can register the following for Web content.
HTML files, CSS files, JavaScript, image data, Perl scripts, php scripts
- You can use SQLite3 as a database.
- If including scripts in Web content, follow the naming rules below.
For Perl scripts: *.cgi
For php scripts: *.php
- Zip the files to be registered all together. The zip file name is arbitrary.

CAUTION

- Use one-byte alphanumeric characters (ASCII characters) for a zip file name and sub-folder name.
- The maximum size of the files before zipping is 100 MB. Otherwise, registering fails.

Cautions for the files to be registered

- Web contents cannot be registered additionally. All files are overwritten and registered. Zip web contents before registering.

<Example for sample program>

```
ePOS-Device_UM_E_Sample.zip ..... : Zip file
├─ index.html
├─ css
│  └─ *.css
├─ img
│  ├── *.bmp
│  ├── *.jpg
│  └─ *.png
├─ js
│  └─ *.js
└─ sample
   └─ *.html
```

- When you access to registered web contents from an input terminal and so on, the URL differs depending on the folder structure of the zip file.

① `http://[the product's IP address]/index.html`

② `http://[the product's IP address]/webpage/index.html`

①

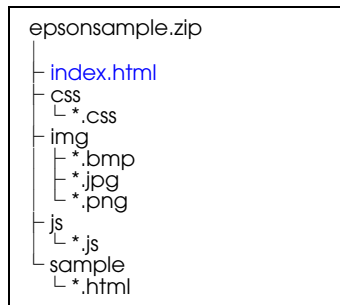

②

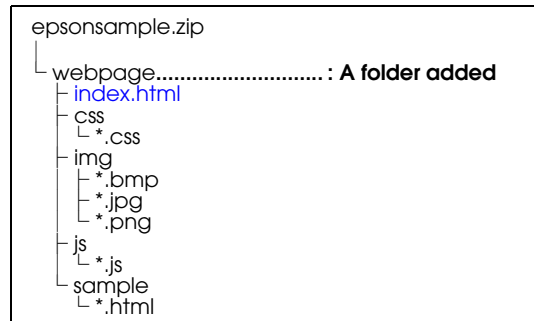

Registering Web content

Use EPSON TMNet WebConfig to register Web contents on this product, following the procedures below.

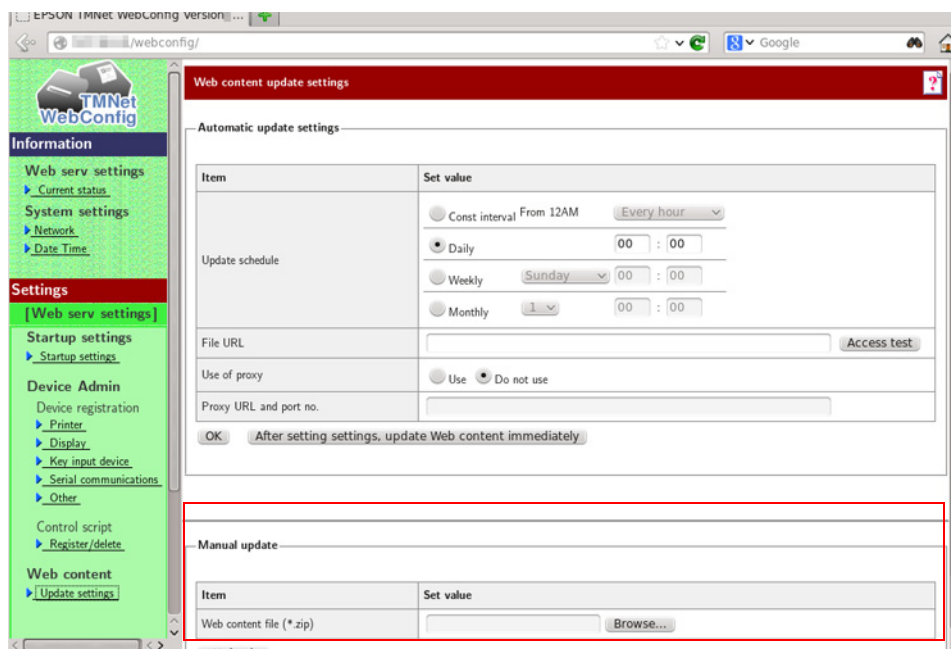

- 1 Start a Web browser of the PC for the settings, and input the following.
`http://This product's IP address/webconfig/`
 EPSON TMNet WebConfig starts.
- 2 Select (Web serv settings), then (Update settings).
 The "Web content update settings" screen is displayed.
- 3 Select (Browse...), and specify the file (zip file format) you want to register, then click (Upload).

Registering device control script files

Use EPSON TMNet WebConfig to register device control scripts on this product, following the procedures below.

NOTE

This registration is used when registering device control script files, such as serial communication devices, using ePOS-Device.

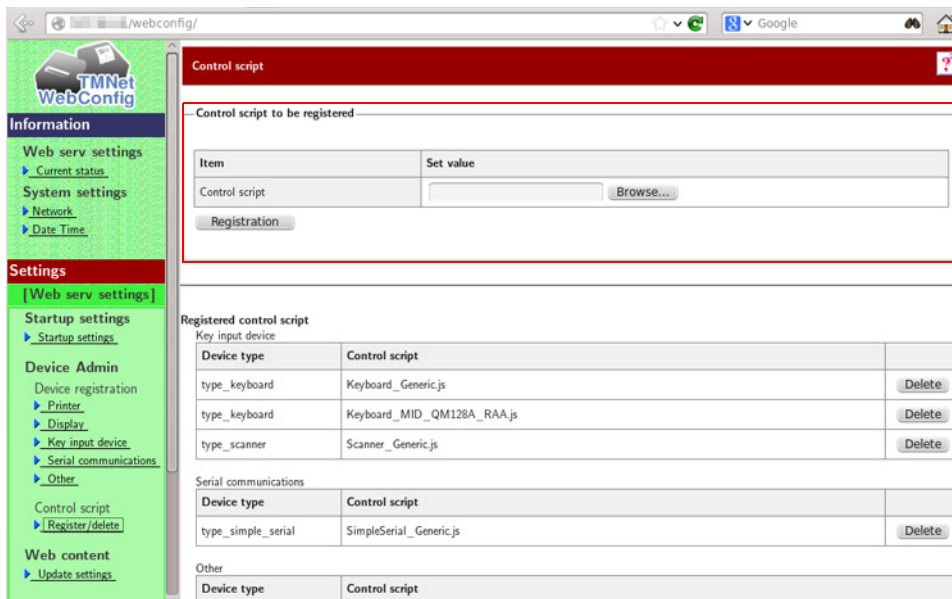

- 1 Start a Web browser of the PC for the settings, and input the following.
`http://This product's IP address/webconfig/`
EPSON TMNet WebConfig starts.
- 2 Select (Web serv settings), then (Register/delete).
The "Control script" screen is displayed.
- 3 Select (Browse...), and specify the control script you want to register,
then click (Registration).

Attaching the Optional Customer Display

Setting the Customer Display

DM-D110 (Dedicated Model) has the DIP switches. The functions are follows.

- Displaying self-test
- Setting the communication speed (Serial communication)

In normal use, you do not need to change the settings. If you change this setting, match the setting to that of the product. When used in ePOS-Device API / XML, you need to set with WebConfig.

DIP Switch Functions

CAUTION

- Remove the USB cable from the computer and remove the cover of the dip switch. If the USB cable is still connected to the computer during operation, this product may break down due to a short circuit, etc.
- If you open the DIP switch cover, be sure to close the cover after setting the DIP switch. When used without the cover, it may cause a malfunction.

DSW No.	Function	ON	OFF	Default
1-1	Received Error Data	Ignore	Displays "?"	OFF
1-2	Receive Data Length	7bit	8bit	OFF
1-3	Parity	With Parity	No Parity	OFF
1-4	Parity Selection	Even	Odd	OFF
1-5	Communication Speed Switching	Refer to " Communication Speed Switching"		ON
1-6				OFF
1-7				ON
1-8	Execution of Self-Test *1	Yes	No	OFF

*1: Executes the self-test once only when the power is turned on.

Communication Speed Switching

SW1-5	SW1-6	SW1-7	Communication Speed (bps)
ON	ON	ON	2400
OFF	ON	ON	4800
ON	OFF	ON	9600
OFF	OFF	ON	19200
ON	ON	OFF	38400
OFF	ON	OFF	57600
ON	OFF	OFF	115200
OFF	OFF	OFF	(Reserved)

How to set the DIP switch

- 1** Disconnect the cable connecting the DM-D110 (Dedicated Model).
- 2** Remove the DIP switch cover.
- 3** Switch the switch with something pointy.
- 4** Close the DIP switch cover.

Connecting the Customer Display

Connect the optional customer display (DM-D110 (Dedicated Model)) to this product with a USB cable.

When you want to use the product without any customer display, skip this section and go to the next procedures.

Connecting External Devices

NOTE

Connect external devices as necessary.

Connecting a Mouse and Keyboard

Connect a USB mouse and USB keyboard to the USB connectors.

NOTE

When connecting the USB keyboard, keymap specified on the OS might not match the keymap of the connected keyboard. If this occurs, specify the keymap settings.

Connecting a Display

Connect a display to the VGA connector.

CAUTION

Connect the display when this product is off.
If you connect the display when this product is on, data may not be properly displayed.

Connecting a Printer

Connect a printer that is supported by the system and applications. You can connect it using the following methods.

- USB connection
- Serial connection
- Network connection

(For network printers, we recommend setting the IP address in advance.)

NOTE

The connection method varies depending on your system in operation. For details, refer to ["Development Information for Each System" on page 135](#).

Connection POS Peripherals

- Connect POS peripherals with USB interface to the USB connectors.
- Connect POS peripherals with serial interface to the COM connector or use USB-serial conversion cables to convert them and connect them to the USB connectors, and install the drivers for each model. For details such as the order in which to connect them, refer to each device's user's manual.
- You can perform the connection test from EPSON TMNet WebConfig. For details, refer to "[Setting the Devices](#)" on page 77.

NOTE

Dedicated drivers are necessary, depending on the devices. Acquire and install the drivers as necessary.

Connecting the Cash Drawer

When using a cash drawer, connect the cash drawer.

Use the cash drawer handled by EPSON or your dealer.

Connecting the Drawer Kick-out Cable



- **Specifications of drawers differ a great deal, depending on makers or models. When you use a drawer other than the specified, make sure its specifications meet the following conditions.**

Otherwise, devices may be damaged.

- * The load, such as a drawer kick-out solenoid, must be connected between pins 4 and 2 or pins 4 and 5 of the drawer kick-out connector.
- * When the drawer open/close signal is used, a switch must be provided between drawer kick-out connector pins 3 and 6.
- * The resistance of the load, such as a drawer kick-out solenoid, must be $24\ \Omega$ or more or the input current must be 1A or less.
- * Be sure to use the 24V power output on drawer-kick out connector pin 4 for driving the equipment.
- **Use a shield cable for the drawer connector cable.**
- **Two driver transistors cannot be energized simultaneously.**
- **Leave intervals longer than 4 times the drawer driving pulse when sending it continuously.**
- **Be sure to use the printer power supply (connector pin 4) for the drawer power source.**
- **Do not insert a telephone line into the drawer kick-out connector.**
Doing so may damage the telephone line or printer.

Connect the connector of the drawer kick-out cable to the printer.

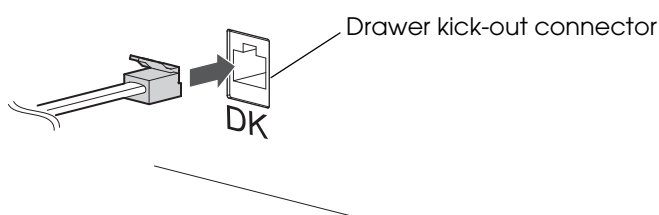

Drawer Connection Circuitry

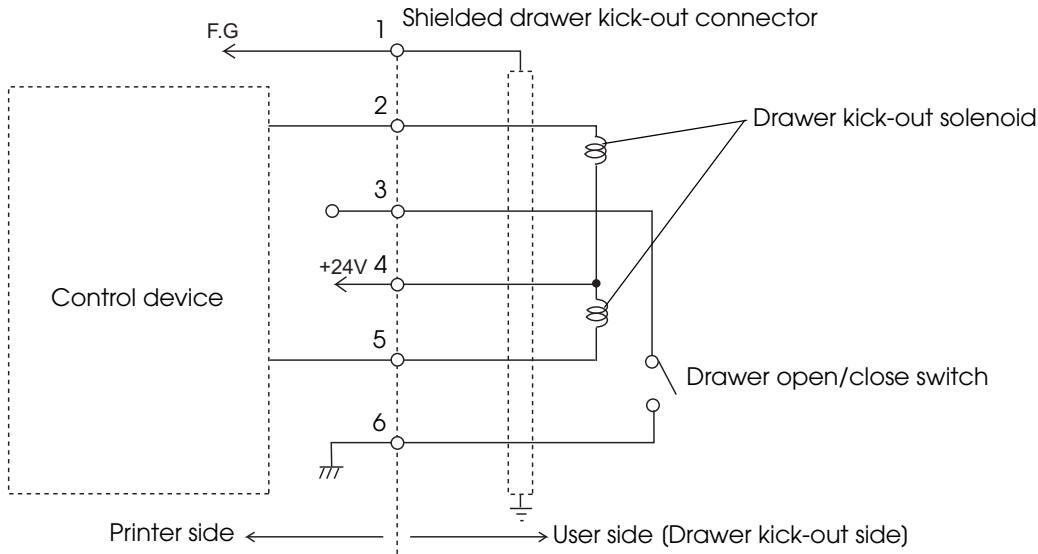

Setting the Devices

Registering a Printer

Use EPSON TMNet WebConfig to register a network printer on this product, following the procedures below. This product's printer is already registered, so settings are not necessary.

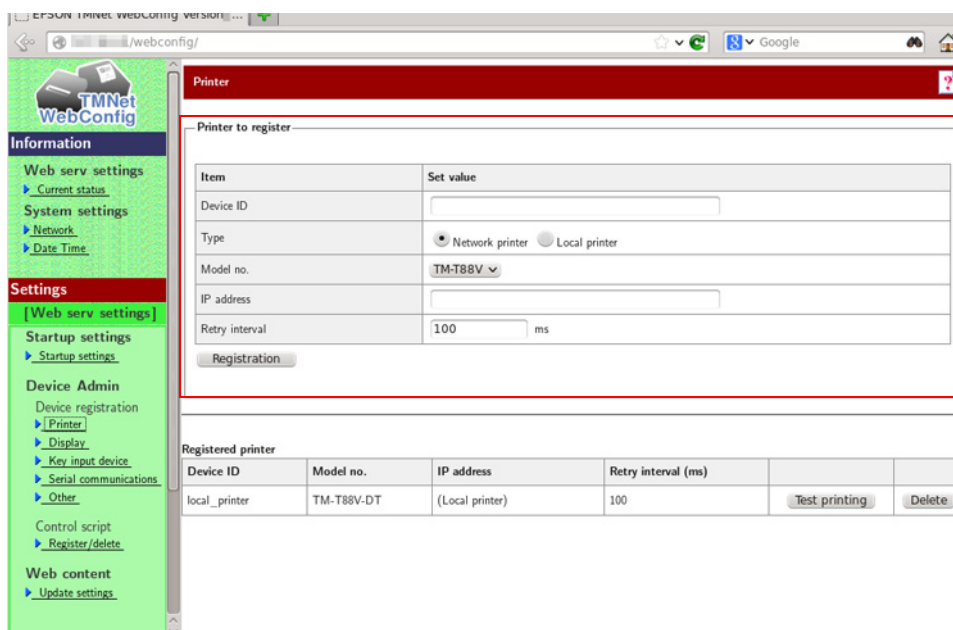

- 1 Start a Web browser of the PC for the settings, and input the following.
<http://This product's IP address/webconfig/>
 EPSON TMNet WebConfig starts.
- 2 Select (Web serv settings), then (Printer).
 The "Printer" screen is displayed.

-
- 3** Set the following, then click (Registration).
The information for the registered device is displayed in (Registered printer).

Item	Description
Device ID	Set the device ID for the printer you want to register. (Any character string)
Type	Select network printer.
Model no.	Select the printer model.
IP address	Input the IP address of the printer you want to control.
Retry interval	Set the printer's retry interval.

- 4** Click (Test printing) and check if the registered printer operates properly.

Customer Display Settings

Use EPSON TMNet WebConfig to register the dedicated customer display DM-D110, following the procedures below.

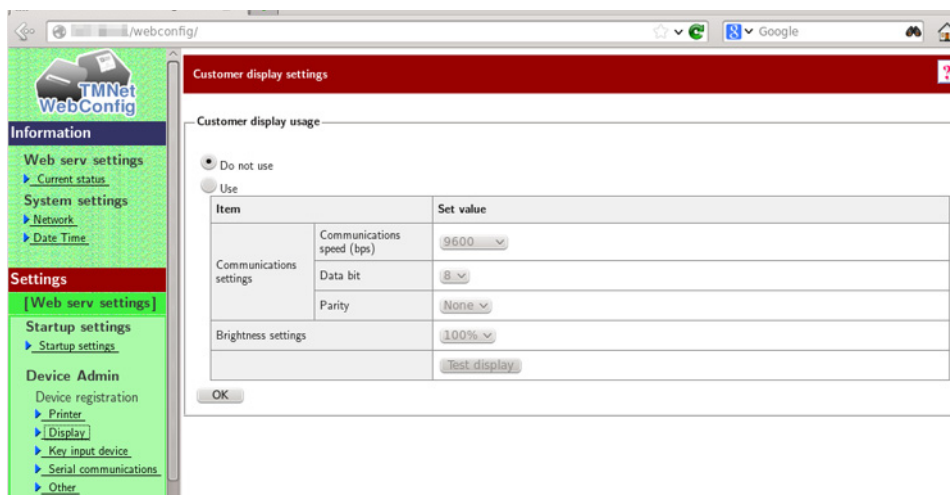

- 1 Start a Web browser of the PC for the settings, and input the following.
http://This product's IP address/webconfig/
EPSON TMNet WebConfig starts.
- 2 Select (Web serv settings), then (Display).
The "Customer display settings" screen is displayed.
- 3 Select (Use) and perform the following settings.

Item	Description
Communications settings	Used for customer display communication settings. If you changed the DM-D110 (Dedicated Model) dip switch settings, change the communication settings in accordance with those changes. (If you do not change the dip switch settings, use the default settings.)
Brightness settings	Set the brightness of the customer display in percentages. You can set 20%, 40%, 60%, or 100%. The maximum brightness is 100%.

Device ID for the dedicated customer display is fixed to "local_display".

- 4 Check the settings and click (OK).

Registering a Key Input Device

Use EPSON TMNet WebConfig to register a key input device on this product, following the procedures below.

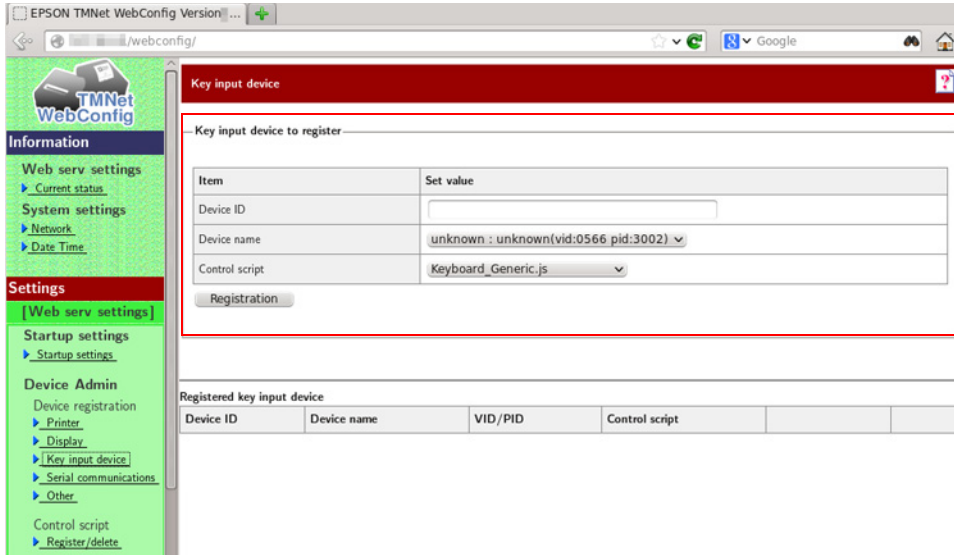

- 1 Start a Web browser of the PC for the settings, and input the following.
<http://This product's IP address/webconfig/>
 EPSON TMNet WebConfig starts.
- 2 Select (Web serv settings), then (Key input device).
 The "Key input device" screen is displayed.
- 3 Set the following, then click (Registration).
 The information for the registered device is displayed in (Registered key input device).

Item	Description
Device ID	Set the device ID for the key input device you want to control.
Device name	Select the key input device model. Unregistered key input devices that are currently connected to the unit are listed.
Control script	Select the script to control the device.

- 4 Click the (Operating test).
The (Operating test -- Webpage Dialog) screen is displayed.



- 5 Use the key input device, and check if the registered key input device operates properly.

Serial Communication Device Registration

Use EPSON TMNet WebConfig to register a serial communication device with this product, following the procedures below.

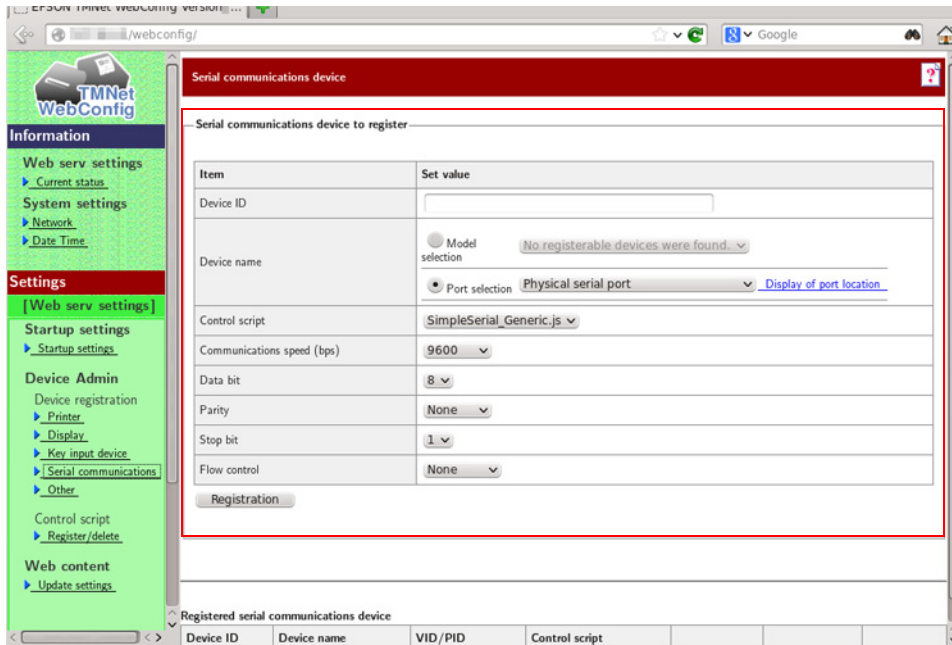

- 1 Start a Web browser of the PC for the settings, and input the following.
`http://This product's IP address/webconfig/`
EPSON TMNet WebConfig starts.
- 2 Select (Web serv settings), then (Serial communications).
The "Serial communications devices" screen is displayed.
- 3 Set the device ID. (Any character string)

4 Select the product name or port for the serial communication device.

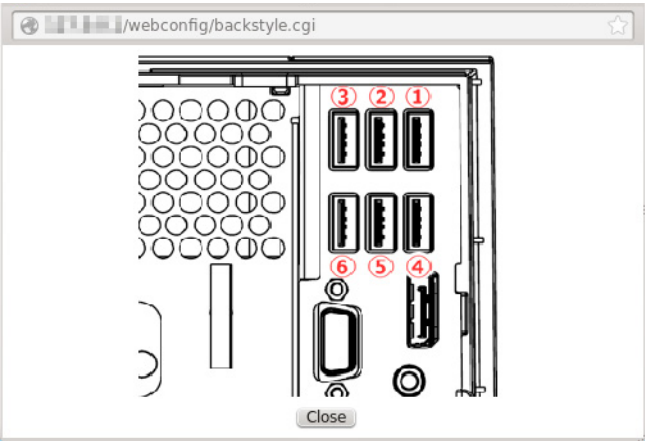
Item	Description
Physical serial port	This is the serial port on the back of this product.
USB port 1 to 6	<p>These are the USB ports on the back of this product.</p> <p>If connecting a serial device using a COM-USB cable, select the corresponding USB port. You can check the USB port number using (Display port locations).</p> 

5 Set the following, then click (Registration). Information of the registered device is displayed in the (Registered serial communications device).

Item	Description
Control script	Select the control script to control the serial communication device.
Communications speed (bps)	Select the communication speed.
Data bit	Select the data bit.
Parity	Select the parity.
Stop bit	Select the stop bit.
Flow control	Select whether there is flow control or not.

Registering Other Devices

Use EPSON TMNet WebConfig to register other devices on this product, following the procedures below.

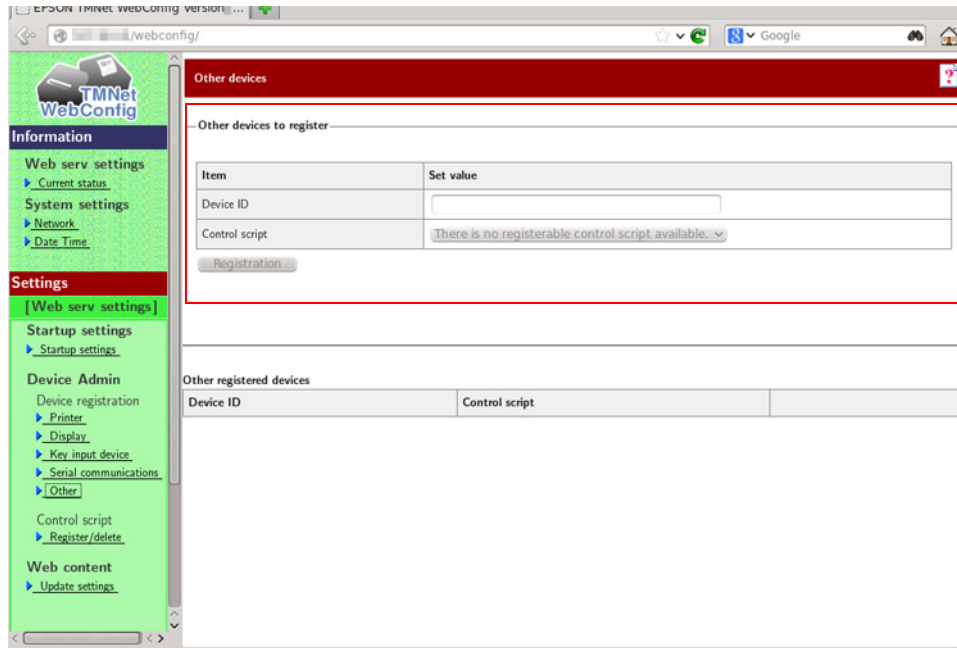

- 1 Start a Web browser of the PC for the settings, and input the following.
<http://This product's IP address/webconfig/>
EPSON TMNet WebConfig starts.
- 2 Select (Web serv settings), then (Other).
The "Other devices" screen is displayed.
- 3 Set the following, then click (Registration).
The information for the registered device is displayed in (Other registered devices).

Item	Description
Device ID	Set the device ID for the device you want to control.
Control script	Select the control script to control the other devices.

Printer Settings

Setting the Memory Switches/Receipt Enhancement

With the memory and R/E (receipt enhancement) function, which are software settings for this printer, you can set the various functions.

For an outline of the functions, see the following section. Use the methods shown in the table below; TM-T70II Utility, Memory Switch Setting Mode, or ESC/POS commands, to set the memory switches and R/E functions.

CAUTION

Start the TM-T70II Utility by using the same Windows computer on the same network as this product. When specifying settings, check that this printer and the computer used for specifying settings are connected to the same network.

Item \ Method		TM-T70II Utility	Memory Switch Setting Mode	ESC/POS Commands	
Memory Switches	Receive buffer capacity	✓	✓	✓	
	BUSY condition	✓	✓	✓	
	Processing when data receive error	✓	✓	✓	
	Auto line feed	✓	✓	✓	
	USB power-saving function	✓	✓	✓	
	Release condition of receive buffer BUSY	✓	✓	✓	
	Error signal output	✓	✓	✓	
	Customized Values	Print density	✓	✓	✓
		Multi-tone print density	✓	✓	✓
		Print speed	✓	✓	✓
		Number of head energizing parts	-	-	✓
		Character code table default	✓	✓	✓
		International character default	✓	✓	✓
		Autocutting after closing cover	✓	✓	✓
		Paper reduction	✓	✓	✓
		Font A auto replacement	-	✓	✓
		Font B auto replacement	-	✓	✓
		Buzzer*	✓	✓	✓
	Communication condition of USB Interface	✓	✓	✓	
Receipt Enhancement	Auto top logo	✓ (Excluding some functions)	-	✓	
	Auto bottom logo	✓	-	✓	
	Auto top/bottom logo extended functions	✓ (Excluding some functions)	-	✓	

*: Not used for this product.

NOTE	<ul style="list-style-type: none"> • For information about the TM-T70II Utility, see the TM-T70II Utility User's Manual. • For information about how to use the memory switch setting mode, see "Memory Switch Setting Mode" on page 155. • For information about ESC/POS commands, see the ESC/POS Command Reference.
-------------	---

Functions

Receive buffer capacity

- 4KB (initial setting)
- 45bytes

BUSY condition

- Receive buffer full/Offline (initial settings)
- Receive bufferfull

CAUTION

- In either case above, the printer enters the BUSY state after power is turned on, and when a self-test is being run.
- If BUSY condition is set to "Receive buffer full," the printer will not become BUSY
 - * When the cover is open
 - * When power is fed by the Feed button
 - * When printing has stopped for paper out
 - * When macro execution ready state
 - * When error has occurred

Processing when data receive error

- Prints "?" (initial setting)
- Ignored

Auto line feed

- Always disabled(initial setting)
- Always enabled

USB power-saving function

- Disabled
- Enabled (initial setting)

CAUTION

The USB power-saving function is valid only when the USB interface communication condition is set to the vendor-defined class and the system configuration is set so that the USB driver can support the USB power-saving function.

Release condition of receive buffer BUSY

- Releases when the remaining receive buffer capacity becomes 256 bytes (initial setting)
- Releases when the remaining receive buffer capacity becomes 138 bytes

CAUTION

This function is enabled only when Receive buffer capacity is set to 4KB.

Error signal output

- Enabled (initial setting)
- Disabled

Print density

Selectable from levels 1 to 13 (70% ~ 130%)

Initial setting: level 7 (100%)

Depending on the paper type, it is recommended to set the print density as shown in the table below for the best print quality.

Original Paper type	Density Level
TF50KS-E, P220AGB-1, AF50KS-E	Level 5 (90%)
TF60KS-E, PD150R, PD160R, PD190R, KT48F20, KT55F20, F5041	Level 7 (100%)
P300, P310, P350	Level 8 (105%)

CAUTION

When the print density level is increased, printing speed may be reduced.

Multi-tone print density

Selectable from levels 1 to 13 (70% ~ 130%)

Initial setting: level 7 (100%)

CAUTION

- First change the print density, and then configure the Multi-tone density.
- In you set the density too high, the contrast becomes lower. Select the density level checking the overall tone balance of your image.

Print speed

Selectable from levels 1 to 13 (Slow ~ Fast)

Initial setting: level 13

NOTE

Depending on print conditions, such as print duty, print head temperature, and data transmission speed, print speed is automatically adjusted, which may cause white lines due to intermittent print (the motor sometimes stops).
To prevent them from occurring, select the print speed to a slow setting value to produce stable print speed.

Selecting the number of head energizing parts

- One-part energizing (initial setting)
- Two-part energizing

NOTE

- Usually, the number of head energizing parts does not need to be changed.
- When printing at the maximum speed, select "One-part energizing."

Character code table default

Selectable from 43 pages including user defined page

Initial setting: Page (PC437: USA, Standard Europe)

NOTE

For the character code table, see ["Character Code Tables" on page 165](#).

International character default

Selectable from 18 sets

Initial setting: USA

NOTE

For the International character sets, see ["International Character Sets" on page 209](#).

Autocutting after closing cover

- * Cuts
- * Does not cut (initial setting)

Paper reduction

- Extra upper space reduction
 - * Disabled (initial setting)
 - * Enabled
- Extra lower space reduction
 - * Disabled (initial setting)
 - * Enabled
- Line space reduction rate
 - * Not reduced (initial setting)
 - * 25%
 - * 50%
 - * 75%
- Line feed reduction rate
 - * Not reduced (initial setting)
 - * 25%
 - * 50%
 - * 75%
- Barcode height reduction rate
 - * Not reduced (initial setting)
 - * 25%
 - * 50%
 - * 75%

CAUTION

- Paper reduction is not performed for space dot lines of graphics printing data.
- When reducing barcode height, be sure to check reading a barcode with your barcode reader in advance.

Font A auto replacement

- * Does not replace (initial setting)
- * Font B

Font B auto replacement

- * Does not replace (initial setting)
- * Font A

Buzzer

Do not change the default setting.

Communication condition of USB interface

- * USB printer class
- * USB vendor-defined class (initial setting)

Auto top logo



TM-T70II Utility does not support the function for Number of lines to be deleted below top logo.

- Key-code
Selectable from key-codes of registered logos
- Alignment
 - * Left (initial setting)
 - * Center
 - * Right
- Number of lines to be deleted below top logo

Auto bottom logo

- Key-code
Selectable from key-codes of registered logos
- Alignment
 - * Left (initial setting)
 - * Center
 - * Right

Auto top/bottom logo extended functions



TM-T70II Utility does not supported the following functions.

- Top logo print while paper feed to the cutting position
- Top logo print while cleaning the buffer to recover from a recoverable error
- Top logo print after paper feeding with the Feed button has finished

- Top logo print while paper feeding to the cutting position
 - * Disabled

- * Enabled (initial setting)
- Top logo print when printer is powered on
 - * Disabled (initial setting)
 - * Enabled
- Top logo print when roll paper cover is closed
 - * Disabled
 - * Enabled (initial setting)
- Top logo print while clearing the buffer to recover from a recoverable error
 - * Disabled
 - * Enabled (initial setting)
- Top logo print after paper feeding with the Feed button has finished
 - * Disabled (initial setting)
 - * Enabled

Registering Logos

You can register logos in the NV (non volatile) memory area in the printer unit and print them. Registering of logos is performed from the TM-T70II Utility on the Windows computer via the network.

NOTE

You can also directly print raster format image data as logos without registering them on the product.

Register Procedures

Follow the steps below to register logos.

CAUTION

Check that this printer and the computer used for specifying settings are connected to the network.

NOTE

It is recommended to write all logos together in the printer when you register more than one logo.

- 1 On the computer used for specifying settings, select (Start)- (All Programs) - (TM-T70II Utility). The TM-T70II Utility is started.
- 2 Click (Add Port).

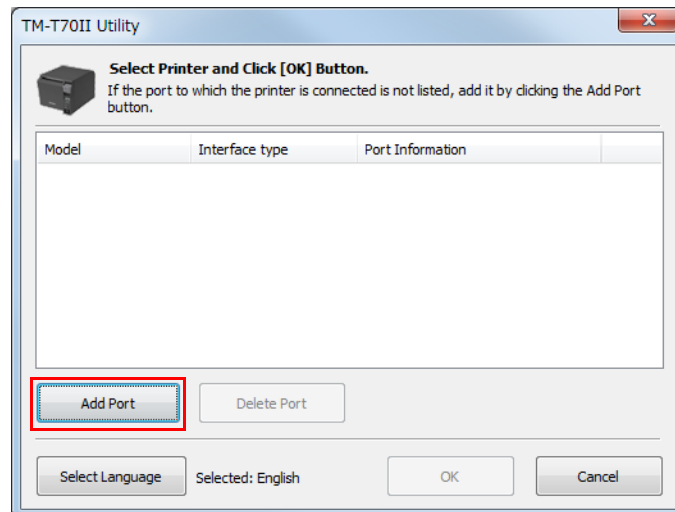

3 Select (Ethernet).

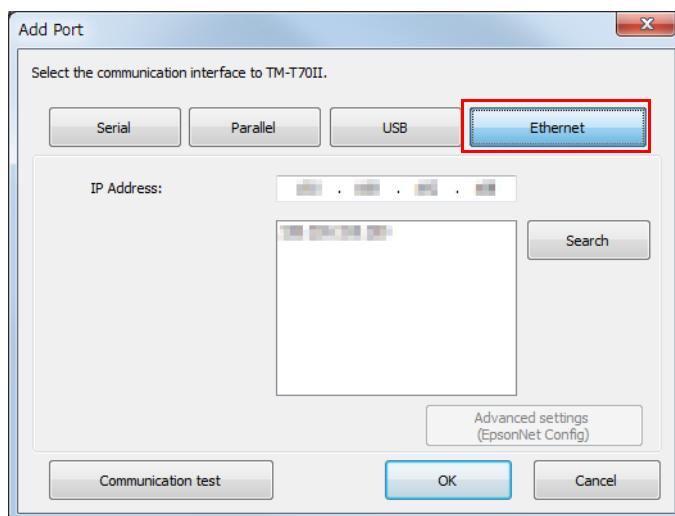

4 Click (Search) and select the IP address of this printer from the displayed IP addresses. Click (OK).

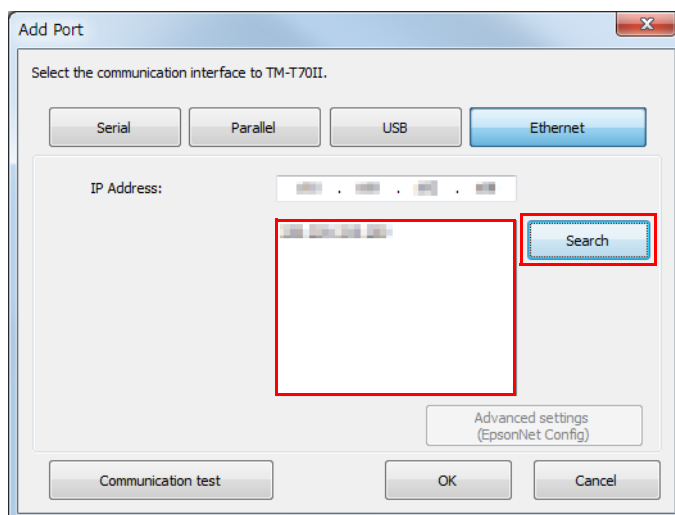

Display returns to the port selection screen.

NOTE

- If the IP address of this printer is not displayed when [Search] is clicked, input the IP address of this printer in the [IP Address:] input field, then click [OK].
- Click [Communication Test] to perform a communication test for this printer. Epson recommends performing a communication test before adding this printer.

5 Select this printer. Click (OK).

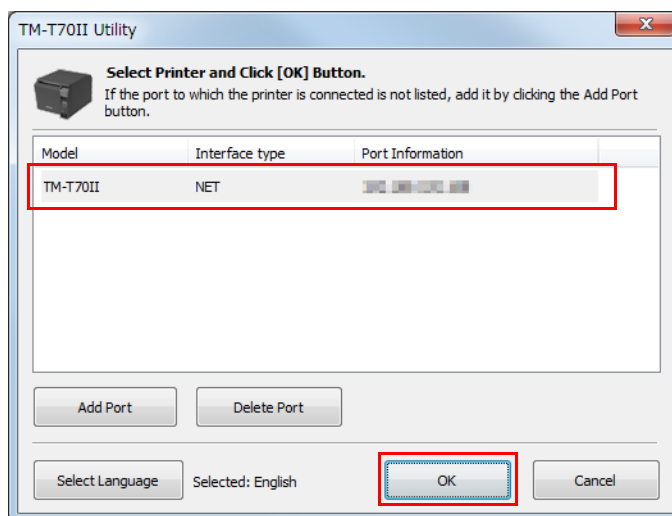

6 Select (Storing Logos), and then click (Add).

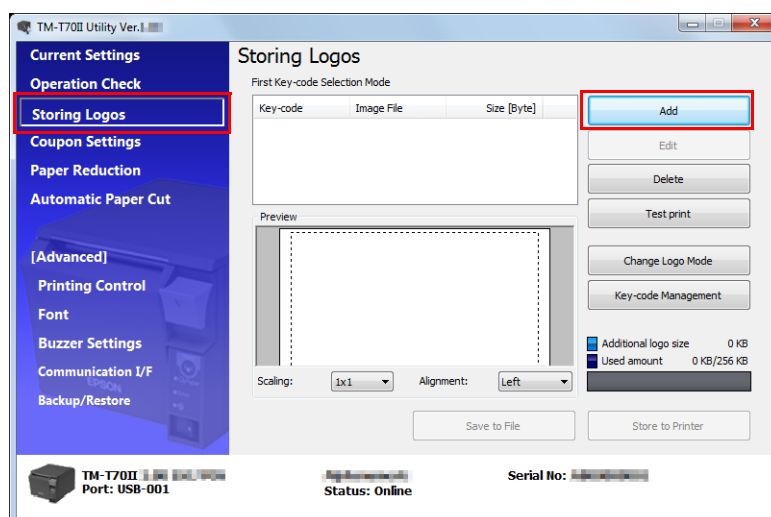

7 Specify the image data file for logo.

The file must be smaller than W: 2047 × H: 831 pixels (dots) in bmp, jpeg, gif, or png format.

NOTE

If the logo width exceeds the paper width (80 mm printing: 512 dots, 58 mm printing: 360 dots), an error message appears. Click [OK], and go to Step 4 to reduce the size in the [Logo Edit] screen.

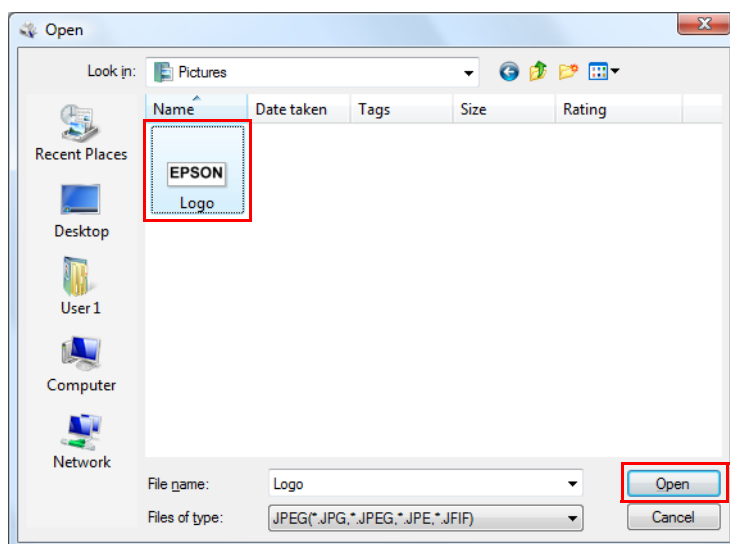

8 On the (Logo Edit) screen, click (Monochrome) or (Multi-tone) to select the image format to output.

[Monochrome] reduces the colors to black and white. [Multi-tone] reduces the colors to 16 colors (graduation) in grayscale.

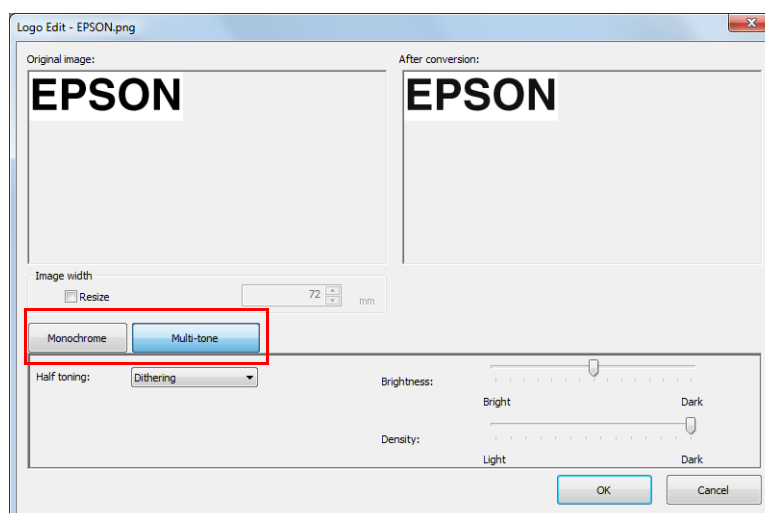

NOTE

When the Mode for Storing Logo is set to “Key-code Nonuse Mode (not recommended),” [Multi-tone] does not appear.

- 9 Edit the image data checking the preview window on the right, and then click (OK).

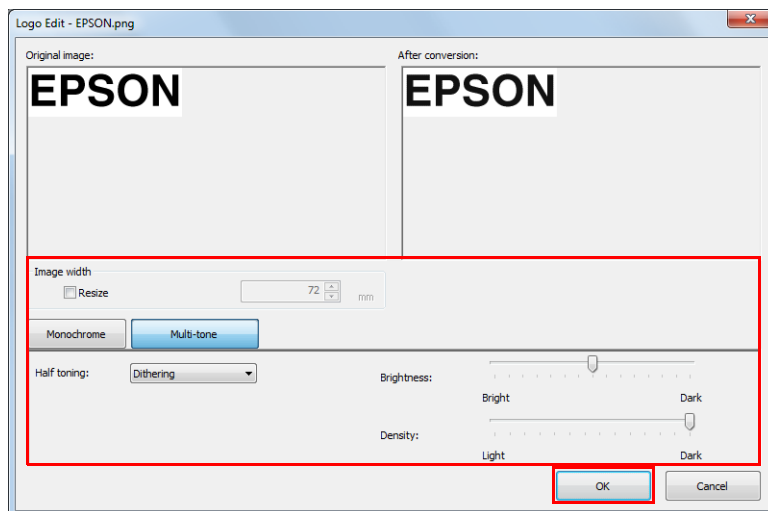

Item	Description
Resize	Set whether you will resize the image or not and the image size after resizing. (Units: mm) If the image size is wider than the paper width and it is not resized, the part out of the paper width will not be printed.
Half toning	Select from Dithering, Error diffusion, or None. If Monochrome is selected in Step 4, Halftoning cannot be changed.
Brightness	Set the brightness.

When Mode for Storing Logo is set to “First Key-code Selection Mode” and the checkbox for [Automatically set the key-code for the logo to be stored] is not checked, the [Key-code Settings] screen appears (Step 6).

- 10 Set a key code, and then click (OK).
Logo data is added to the list.

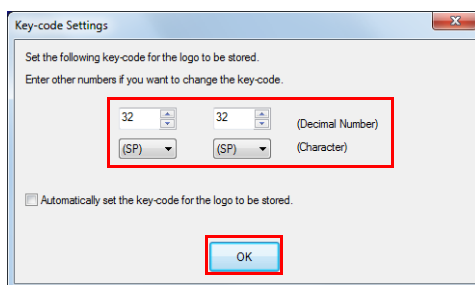

- 11 When you register more than one logo, repeat the Steps 1 to 6.
- 12 After registering all logo data, check the indicator on the right to make sure that the data size is small enough to write in the printer, and then click (Store to Printer).

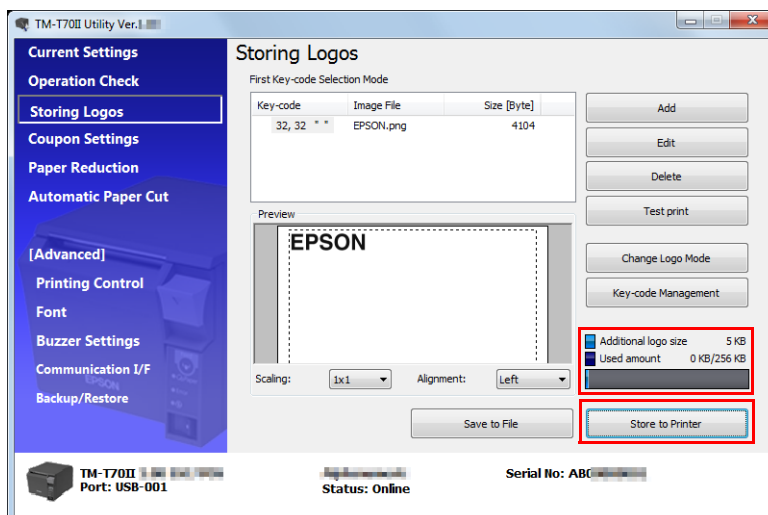

The logo data is stored in the printer.

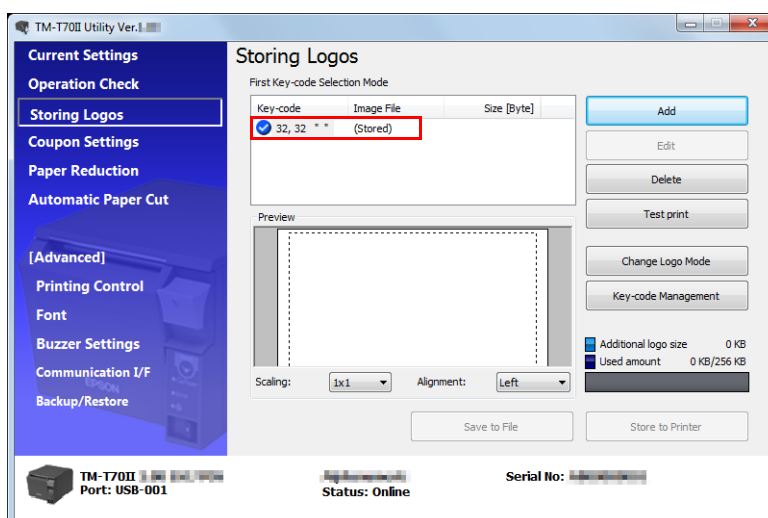

Product Settings

Changing the Session

You can change the session at the login screen. The setting at the time of factory shipment is [KDE Plasma Workspace].

At the login screen, select [Menu] - [Session Type]. Select [GNOME] or [KDE Plasma Workspace] from the list. Log in to display the selected session screen.

The selected session is stored in memory and applied from your next login and thereafter.

Starting YaST

How to start YaST from the GUI of KDE:

Click the icon at the lower-left of the screen, then select [Computer] - [YaST].

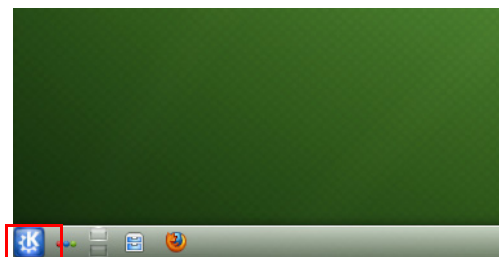

The password is the root user password of "TMDT".

How to start YaST from the command line:

You can start YaST by using the following commands.

```
>su
```

```
Password:(root user's password "TMDT")
```

```
#!/sbin/yast2
```

Resolution settings

The items shown below, including this resolution information, are displayed as start options when the printer (main body) is started. Select the item that corresponds to the display that you are using.

- openSUSE 640x480
- openSUSE 800x600
- openSUSE 1024x768
- openSUSE 1280x1024
- openSUSE 1600x1200
- openSUSE 12.2 (Failsafe)

NOTE

openSUSE 12.2 (Failsafe) is the mode used when a system fault occurs. The system is started with the selected optimal resolution.

Default resolution setting

- 1** Start YaST.
(For details on starting YaST, refer to ["Starting YaST" on page 98.](#))
- 2** Select (System) - (Boot Loader).
- 3** "Boot Loader" screen is displayed. Select the resolution you want to set as the default, then click (Set as Default). After selecting, click (OK).

CAUTION

- Using [Set as Default] sets the specified resolution as the default resolution. The computer might not start if the kernel start option for edit is changed. Only change this option if you fully understand the affects of making such a change.
- Starting is not affected by changing the order of the options or by the [Set as Default] operation.

Changing DisplayLanguage

You can change the display language according to the procedures described below.

CAUTION

Always be sure to change the display language on YaST.

- 1 Start YaST.
(For details on starting YaST, refer to ["Starting YaST" on page 98.](#))
- 2 Select (System) - (Language).
- 3 "Language" screen is displayed. Set "Primary Language" and "Secondary Language", then click (OK).
- 4 Log out once and then log in again.

NOTE

The language will not be changed unless you log in again.

Power button settings

KDE

- 1 Click the icon at the lower-left of the screen, select (Applications) - (System Settings).

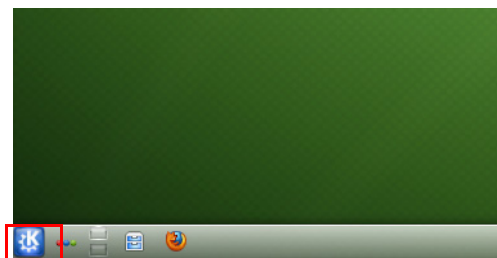

- 2 "System Settings" screen is displayed. Click (Power Management).
- 3 "Power Management" screen is displayed. Set for (Button events handling).

GNOME

- 1** Start the dconf editor.
- 2** Select (org) - (gnome) - (settings-daemon) - (plugins) - (power).
- 3** Settings are displayed on the light-side of the screen. Set for (Power button action).

Time settings

- 1** Start YaST.
(For details on starting YaST, refer to ["Starting YaST" on page 98.](#))
- 2** Select (System) - (Date and Time).
- 3** "Date and Time" screen is displayed. Set (Region), (Time Zone), and (Date and Time), then click (OK).

Auto-mount settings

- 1** Start the dconf editor.
- 2** Select (org) - (gnome) - (desktop) - (media-handling).
- 3** Settings are displayed on the light-side of the screen. Set for auto-mount.

Attaching the Connector Cover

Attach the connector cover to protect the cables by following the steps below.

- 1 Align the tab on the connector cover with the dent on the main body.

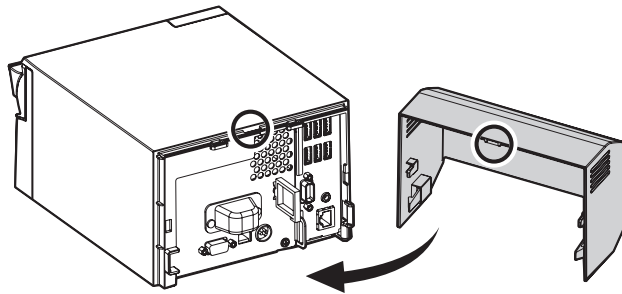

- 2 Push the connector cover with the dent on the main body.

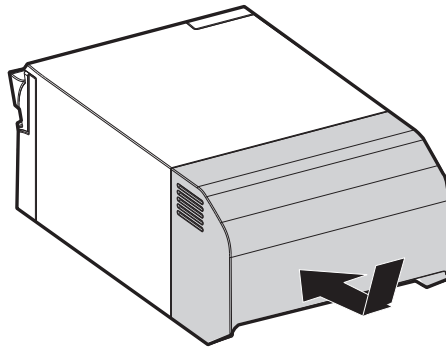

- 3 Make sure the cables are not pinched.

Removing the Connector Cover

Lift up the lower part of the connector cover while pushing down the center of the connector cover to detach it from the main body.

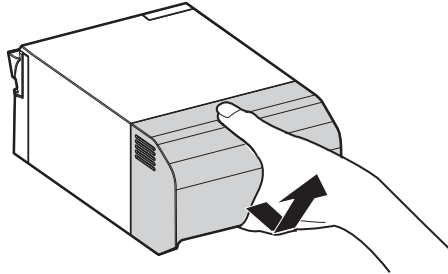

Attaching the Power Button Cover

Attach the power button cover that comes with the product onto the power button to prevent accidental operation of the power button.

Follow the steps below to attach the power button cover.

NOTE

It is recommended to clean the area around the power button with a cloth moistened with alcohol before you attach the cover.

- 1 Open the power button cover.

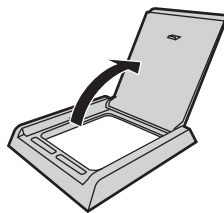

- 2 Peel off the backing paper.

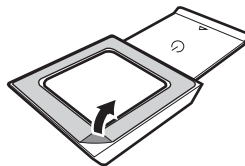

- 3 Attach the power button cover as shown in the illustration.

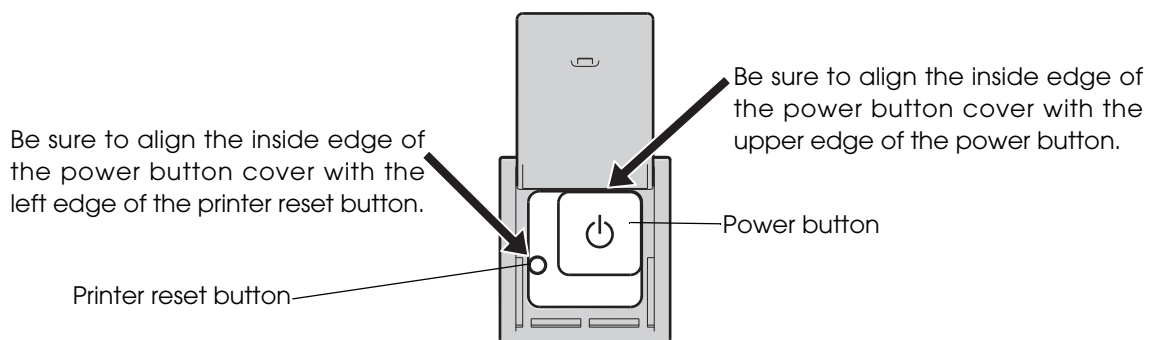

Preinstalled OS Information

openSUSE

Preinstallation information

Item	Details	
SSD format		
	File system	ext3
	Volume label	TM-DT
Preinstalled software*		
	OS	Linux [®] based on openSUSE
	Driver	N2600+NM10
		Embedded VGA driver
		Sound driver
		Network controller driver
		OT-WL01 driver (Wireless LAN driver)
		Virtual COM port driver
		LED control driver
	Tool	TMT-CUPS driver (Driver for EPSON TM printer)
		JavaPOS (The installer is bundled)
		ePOS-Device Version 2.00
		Mozilla Firefox Version 19.02
Network information (Default)		
	IP address	192.168.192.168
	Subnet mask	255.255.255.0
User information (Default)		
	User Name	EPSON-USER
	User Password	TMDT
EPSON TMNet WebConfig Information (Default)		
	User Name	epson
	User Password	epson

*: This product is based on openSUSE 12.2. The following software is excluded from standard installation. You can add software by mounting the openSUSE 12.2 DVD.

- Multimedia

- Office Software
- Graphics
- Games
- Disc Proprietary branding-openSUSE package

Recovery

Follow the steps below to perform the recovery.

NOTE

- When the recovery procedure is performed, all data will be deleted. Back up any necessary data before performing the procedure.
- Recovery requires about 10 minutes.

- 1** Turn off the power of the product.
- 2** Connect a DVD drive, and a USB keyboard to the product's USB connectors.
- 3** Connect a display to the product's VGA connector.
- 4** Turn on the power of the product, and insert the recovery disk into the DVD drive.
- 5** Restart the product.
- 6** The system starts using the recovery disk. When a message that says "Do you really want to recover internal storage?" is displayed, select (Yes).

CAUTION

You can not cancel recovery by the [*] key.

- 7** A confirmation message that says "All data on the storage will be deleted?" is displayed. Click (Yes).
Recovery is performed.

- 8 The "Ejecting sr0..." message is displayed. The recovery disk is ejected.
- 9 The product automatically starts and the resolution selection screen is displayed.

NOTE

Before the resolution selection screen is displayed, the printer (main body) restarts once to perform initial settings. The resolution selection screen is displayed followed by the login screen being displayed and then the login screen is displayed for only approximately five seconds. After that, the system automatically shuts down and then restarts.

- 10 The login screen is displayed. Input the password to log in.

NOTE

The initial password is "TMDT".

- 11 Set the date, time, and time zone.



Utility

The following explains the utilities equipped in this product.

EPSON TMNet WebConfig

Starting EPSON TMNet WebConfig

Start EPSON TMNet WebConfig using the method below.

- 1 Connect a display and keyboard to the product.
Log in as the Administrator.
- 2 Start TMNet WebConfig from the shortcut on the desktop.
EPSON TMNet WebConfig starts.

NOTE

If you are making settings from an external device, start the Web browser, and input the following.

<http://This product's IP address/webconfig/>

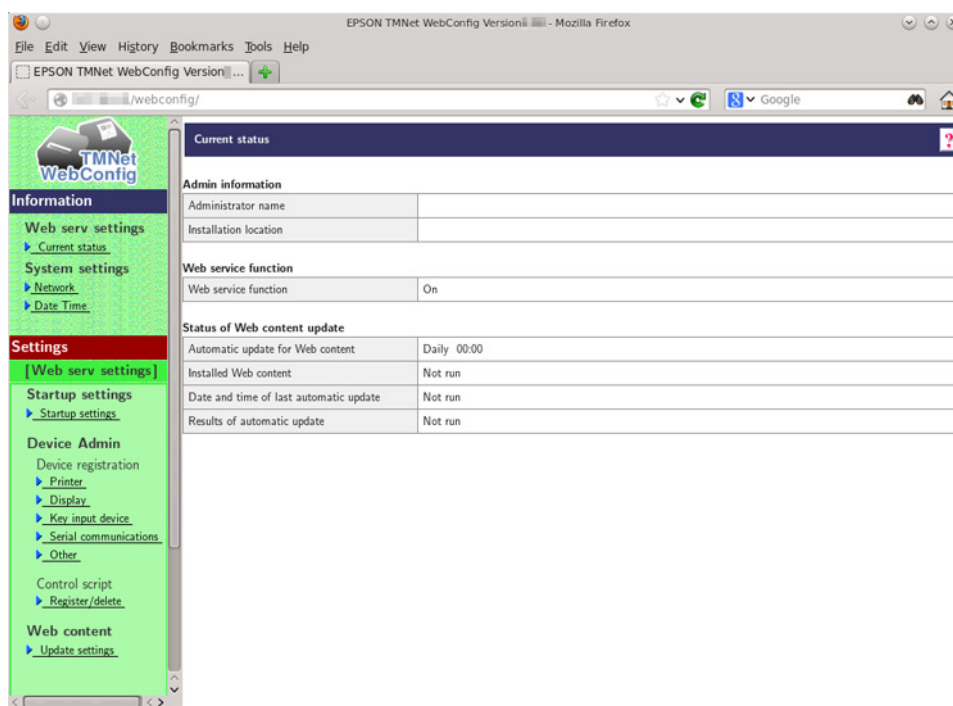

Information - Web serv settings - Current status

You can check the basic settings for this product.

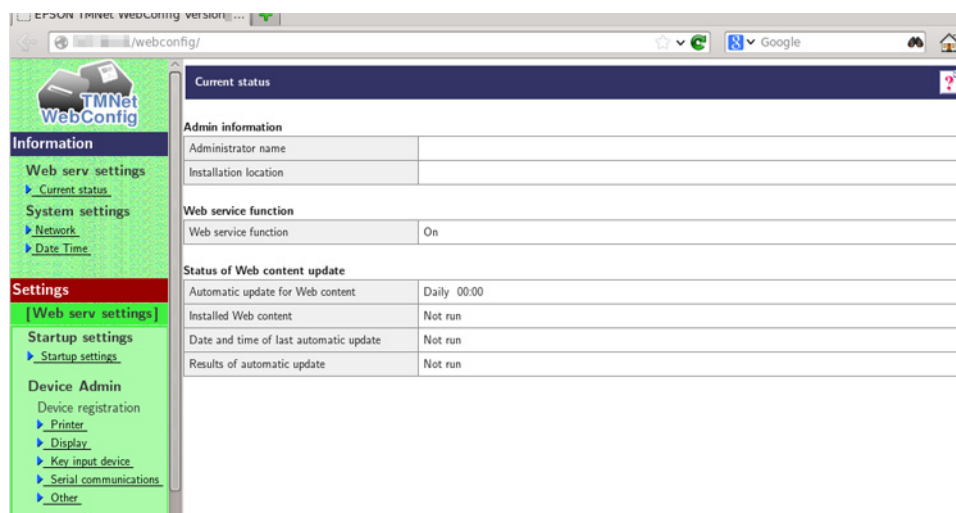

	Item	Description
Admin information	Administrator name	Displays the administrator name for this product.
	Installation location	Displays the installation location for this product.
Web service function	Web service function	Displays whether the Web service function is enabled or not.
Status of Web content update	Automatic update for Web content	Displays the schedule for automatic updates for Web content.
	Installed Web content	Displays the installed Web content.
	Date and time of last automatic update	Displays the date and time of the last automatic update performed.
	Results of automatic update	Displays the results of the automatic update.

Information - System settings - Network

You can check the network settings for this product.

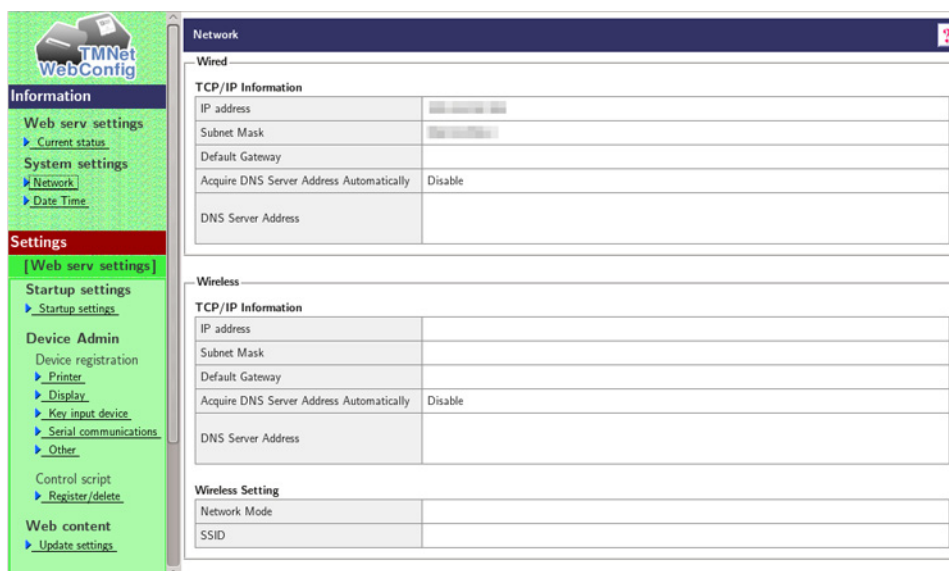

	Item	Description
TCP/IP Information (Wired)	IP address	Displays this product's IP address for a wired LAN network.
	Subnet Mask	Displays the subnet mask.
	Default Gateway	Displays the default gateway.
	Acquire DNS Server Address Automatically	Displays whether the Acquire DNS Server Address Automatically function is enabled or not.
	DNS Server Address	Displays automatically acquired DNS server addresses in the order they are used.

Item		Description
TCP/IP Information (Wireless)	IP address	Displays this product's IP address for a wireless LAN network.
	Subnet Mask	Displays the subnet mask.
	Default Gateway	Displays the default gateway.
	AcquireDNS Server Address Automatically	Displays whether the Acquire DNS Server Address Automatically function is enabled or not.
	DNS Server Address	Displays automatically acquired DNS server addresses in the order they are used.
Wireless Setting	Network Mode	Displays this product's wireless LAN network mode.
	SSID	Displays the SSID for the registered wireless LAN network.

Information - System settings - Date Time

You can check this product's time settings.

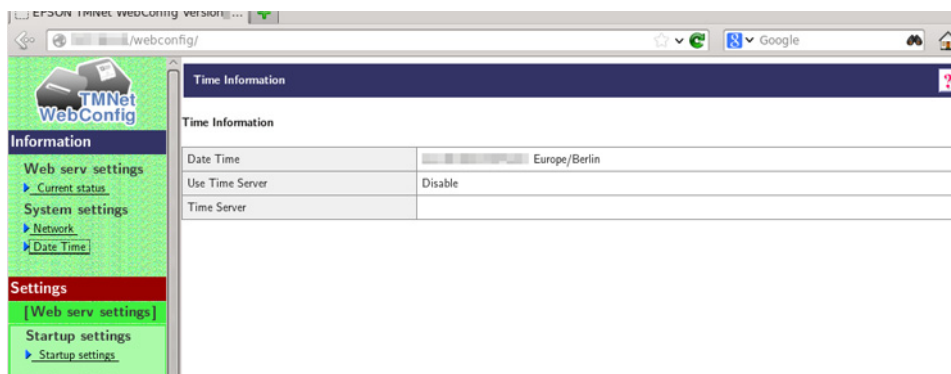

Item	Description
Date Time	Displays the time and the timezone set for this product.
Use Time Server	Displays whether the function to use a time server is enabled or not.
Time Server	Displays the address set as a time server.

Settings - Web serv settings - Startup settings

Performs startup settings for various Web service functions.

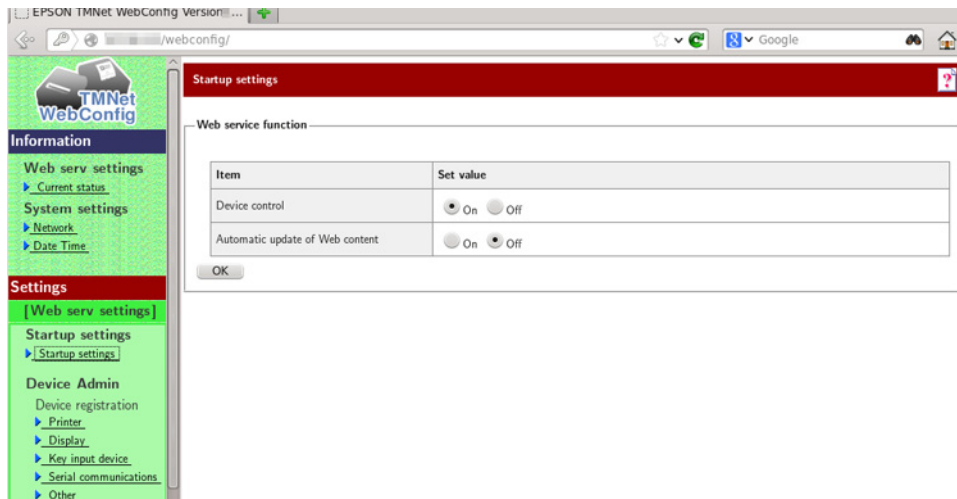

Item	Description
Device control	Enables or disables device control functions that use Web service. Used for ePOS-Device.
Automatic update of Web content	Enables or disables the automatic update function for Web content.
OK	Registers the settings on this product.

Settings - Web serv settings - Printer

Performs the settings for printers controlled by this product.

The screenshot shows the EPSON TMNet WebConfig interface. The browser address bar shows `/webconfig/`. The page title is "Printer".

Printer to register

Item	Set value
Device ID	<input type="text"/>
Type	<input checked="" type="radio"/> Network printer <input type="radio"/> Local printer
Model no.	TM-T88V
IP address	<input type="text"/>
Retry interval	100 ms

Registration

Registered printer

Device ID	Model no.	IP address	Retry interval (ms)		
local_printer	TM-T88V-DT	(Local printer)	100	Test printing	Delete

Item	Description
Device ID	Set the ID for the controlled printer. (Any character string)
Type	Select the type for the controlled printer.
Model no.	Select the model number for the controlled printer.
IP address	Set the printer IP address for each device ID.
Retry interval	Set the timeout retry interval.
Registration	Registers the printer on this product.
Registered printer	Displays a list of registered printers.
Test printing	Performs a test printing. "TEST_PRINT" is printed.
Delete	Deletes a registered printer.

NOTE

The initial value for the device ID for the printer equipped in this product is "local_printer."

Settings - Web serv settings - Display

Performs the settings for the customer display controlled by this product.

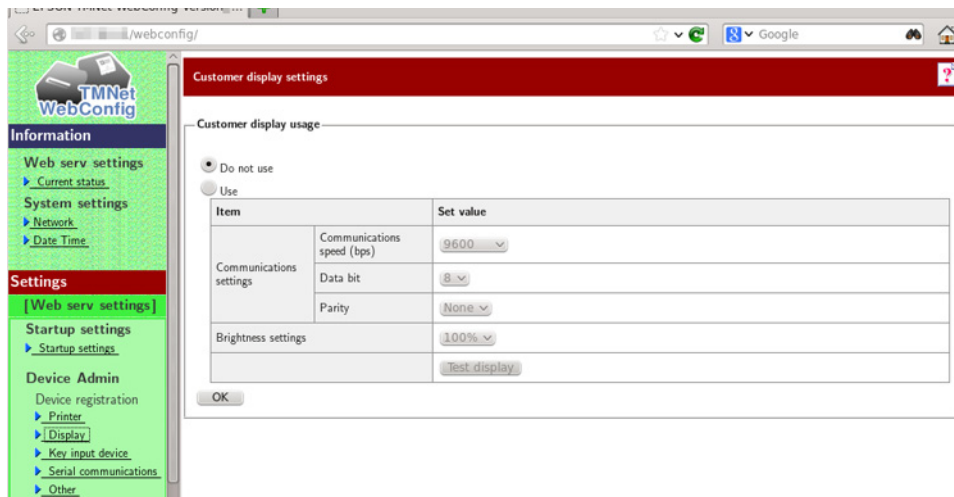

Item		Description
Do not use		Do not use a customer display.
Use		Use a customer display.
Communications settings	Communications speed (dps)	Set the communication speed.
	Data bit	Set the data bit.
	Parity	Set the parity.
Brightness settings		Set the brightness of the customer display in percentages. You can set 20%, 40%, 60%, or 100%. The maximum brightness is 100%.
OK		Registers the settings on this product.

Settings - Web serv settings - Key input device

Performs the settings for the key input device controlled by this product.

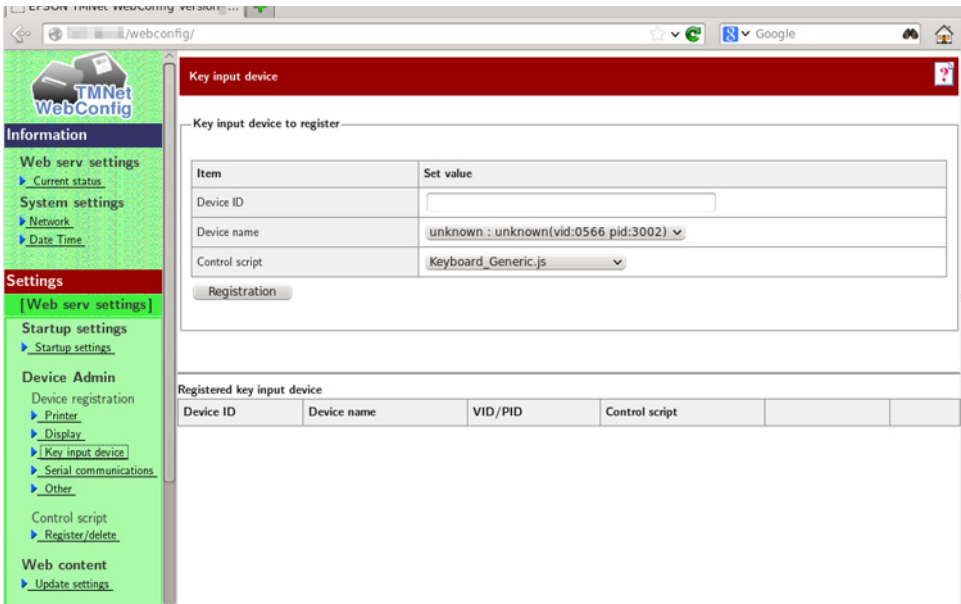

Item	Description
Device ID	Set the ID for the key input device.
Device name	Set the device name for the key input device.
Control script	Set the device control script to control the key input device.
Registration	Registers the key input device.
Registered key input device	Displays a list of registered key input devices.
Operating test	Performs an operating test for a registered key input device.
Delete	Deletes a registered key input device.

NOTE Register device control scripts as necessary. For details, refer to ["Settings - Web serv settings - Register/delete"](#) on page 120.

Settings - Web serv settings - Serial communications

Performs the settings for serial communication devices controlled by this product.

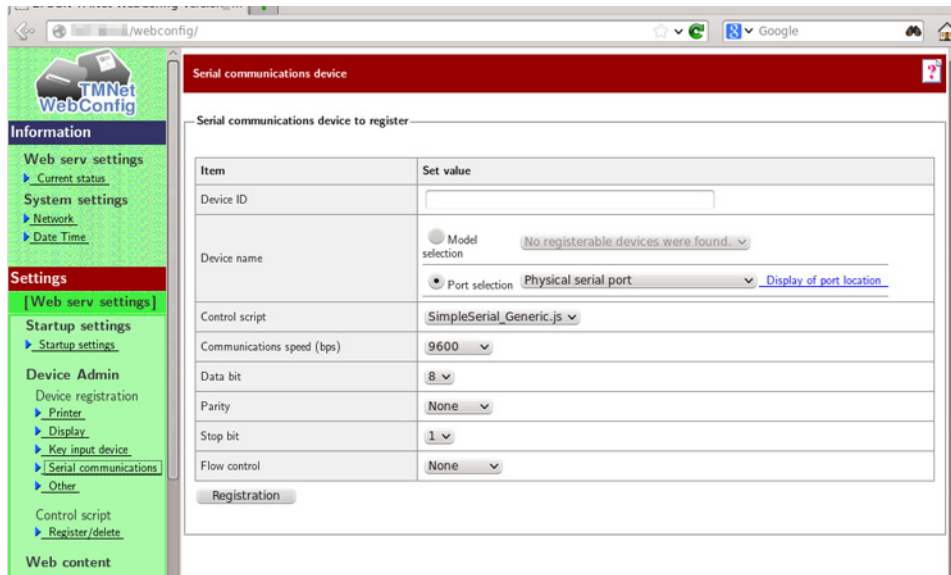

Item		Description
Device ID		Set the device ID.
Device name	Model selection	Select the device model name.
	Port selection	Select the device port.
Control script		Select the device control script for controlling the serial communication device.
Communications speed (bps)		Set the device communication speed.
Databit		Set the data bit.
Parity		Set the parity.
Stop bit		Set the stop bit.
Flow control		Set the flow control.
Registration		Registers the set serial communication device on this product.
Registered serial communications device		Displays a list of registered serial communication devices.

NOTE

Register device control scripts as necessary.
For details, refer to "[Settings - Web serv settings - Register/delete](#)" on page 120.

Settings - Web serv settings - Other

Performs settings for other devices controlled by this product.

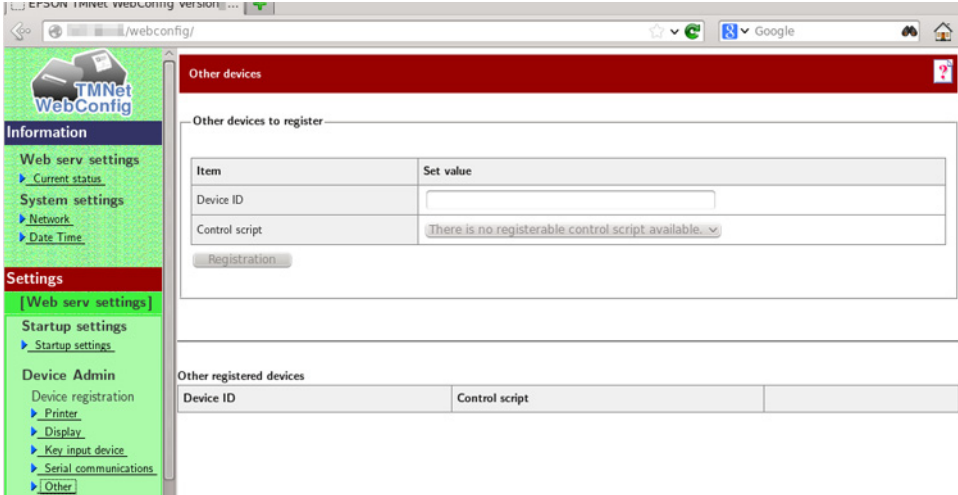

Item	Description
Device ID	Set the ID for the controlled device.
Control script	Set the device control script to control the device.
Registration	Registers the device on this product.
Other registered devices	Displays other devices registered on this product.

NOTE Register device control scripts as necessary. For details, refer to "[Settings - Web serv settings - Register/delete](#)" on page 120.

Settings - Web serv settings - Register/delete

Performs registration or deletion for device control scripts used by this product.

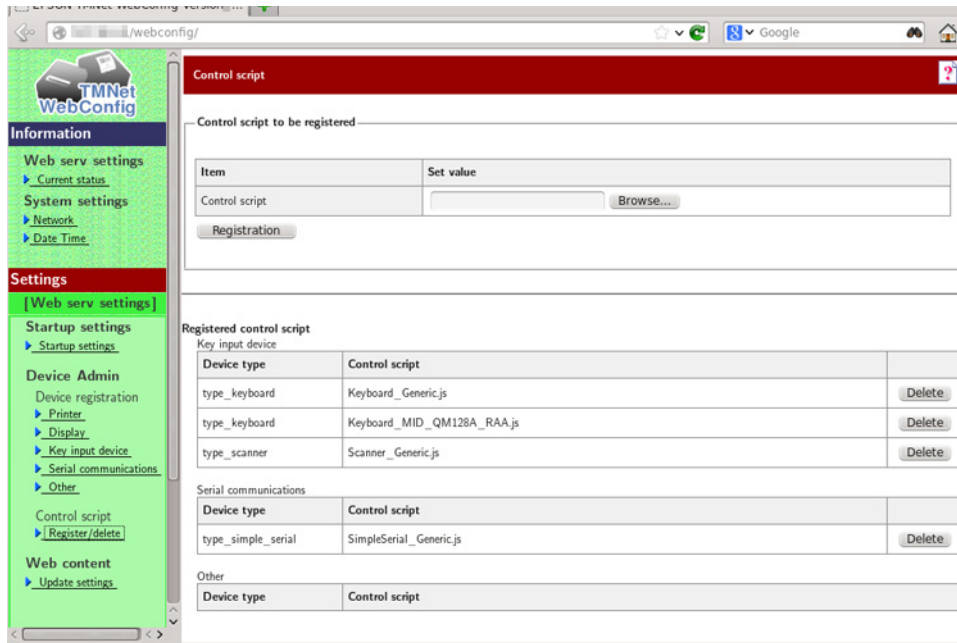

Item	Description
Control script	Set the control script to be registered.
Registration	Registers the device control script on this product.
Registered control script	Displays a list of device control scripts registered on this product based on the device type. Delete: Deletes the corresponding device control script from this product. In use: The corresponding device control script is in use.

Settings - Web serv settings - Update settings

Performs settings for the installation method and update settings for the Web content registered on this product.

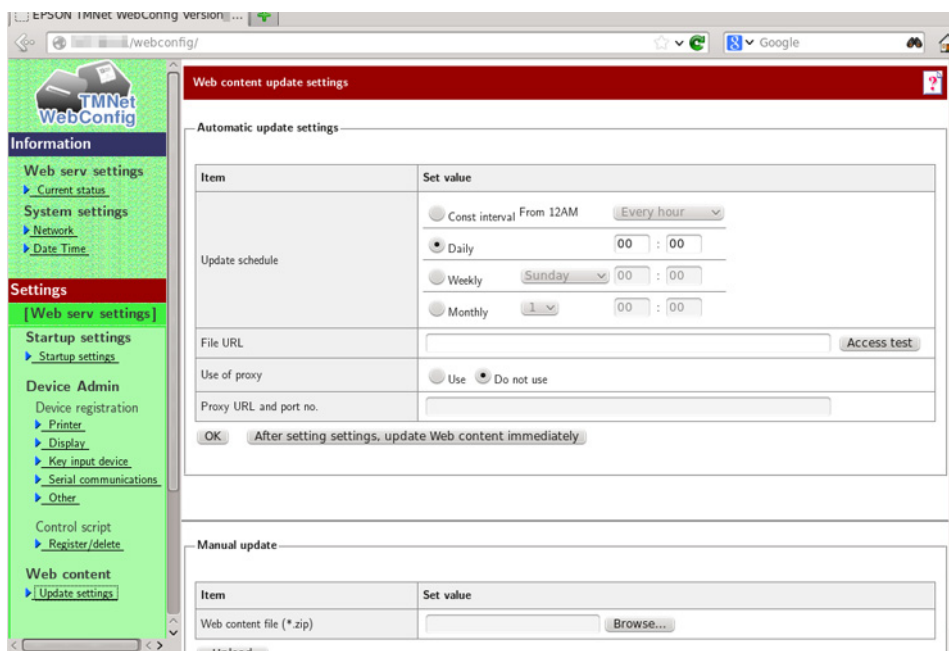

	Item	Description
Automatic update settings	Update schedule	Set the schedule for automatic update of the Web content.
	File URL	Specify a URL for the file to automatically update. After designating it, click "File Access Test" and check if the URL is properly specified.
	Use of proxy	Set whether you are using a proxy server or not. If you selected "Use", set "Proxy URL and port no."
	Proxy URL and port no.	Set the URL and port number for the proxy server in use.
	OK	Registers the automatic update settings on this product.
	After setting settings, update Web content immediately	After the automatic update settings are registered on this product, the Web content will be updated.
Manual update	Web content file (*.zip)	Specify the Web content to be installed.
	Upload	Uploads the specified Web content.

Settings - System settings - TCP/IP (Wired)

Performs TCP/IP settings for this product's wired LAN.

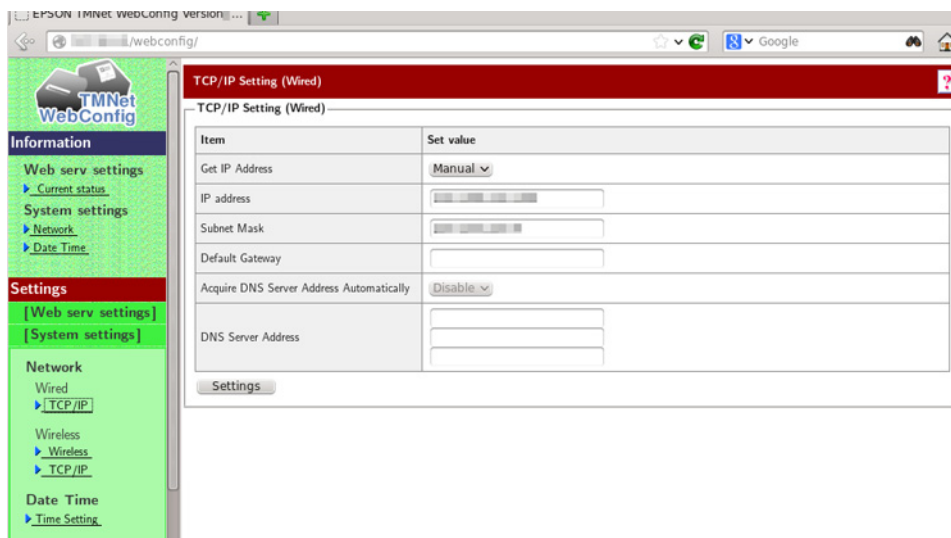

Item	Description
Get IP Address	Selects (Auto) or (Manual) for the method for acquiring the IP address.
IP Address	Specifies the IP address. Only enabled when the method for acquiring the IP address is (Manual).
Subnet Mask	Specifies the subnet mask. Only enabled when the method for acquiring the IP address is (Manual).
Default Gateway	Specifies the default gateway. Only enabled when the method for acquiring the IP address is (Manual).
Acquire DNS Server Address Automatically	Selects (Enable) or (Disable) for automatically acquiring the DNS server address. Only enabled when the method for acquiring the IP address is (Auto).
DNS Server Address	Specifies DNS server addresses in order of use. Can be specified only when (Disable) is selected for automatically acquiring the DNS server address.
Settings	Registers the settings on this product.

Settings - System settings - Wireless Setting

Performs settings for this product's wireless LAN.

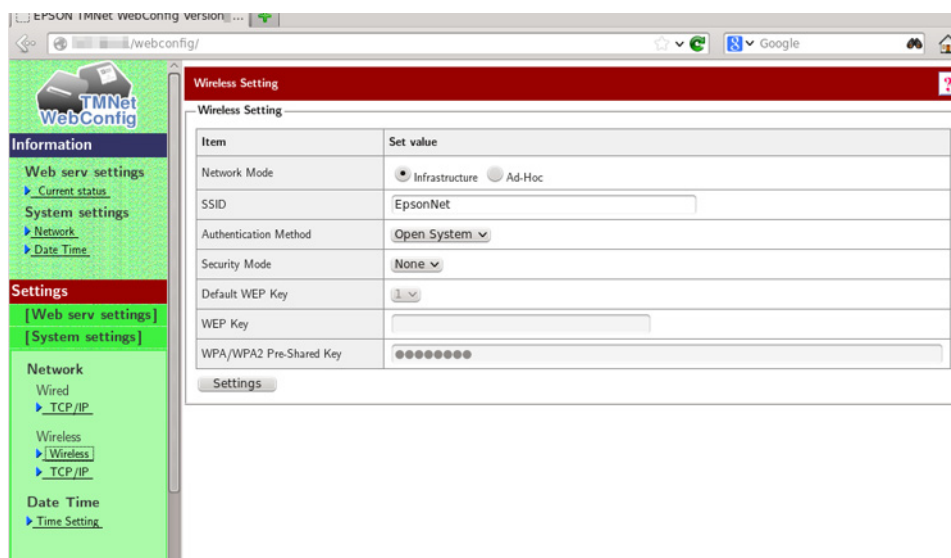

Item	Description
Network Mode	Specifies this product's network mode.
SSID	Specifies the SSID for the SSID network.
Authentication Method	Specifies the authentication method for the wireless LAN network.
Security Mode	Specifies the encryption method for the wireless LAN network.
Default WEP Key	Selects the WEP key used in the wireless LAN network.
WEP Key	Inputs the network WEP key.
WPA/WPA2 Pre-Shared Key	Inputs the pre-shared key used if the encryption method is "WPA" or "WPA2".
Settings	Registers the settings on this product.

Settings - System settings - TCP/IP (Wireless)

Performs TCP/IP settings for this product's wireless LAN.

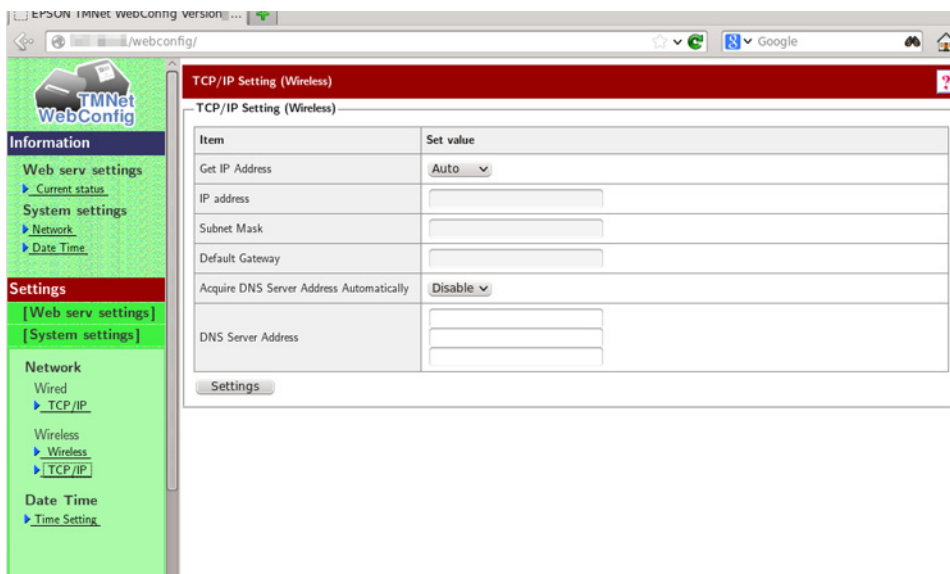

Item	Description
Get IP Address	Selects (Auto) or (Manual) for the method for acquiring the IP address.
IP address	Specifies the IP address. Only enabled when the method for acquiring the IP address is (Manual).
Subnet Mask	Specifies the subnet mask. Only enabled when the method for acquiring the IP address is (Manual).
Default Gateway	Specifies the default gateway. Only enabled when the method for acquiring the IP address is (Manual).
Acquire DNS Server Address Automatically	Selects (Enable) or (Disable) for automatically acquiring the DNS server address. Only enabled when the method for acquiring the IP address is (Auto).
DNS Server Address	Specifies DNS server addresses in order of use. Can be specified only when (Disable) is selected for automatically acquiring the DNS server address.
Settings	Registers the settings on this product.

Settings - System settings - Time Setting

Performs time settings for this product.

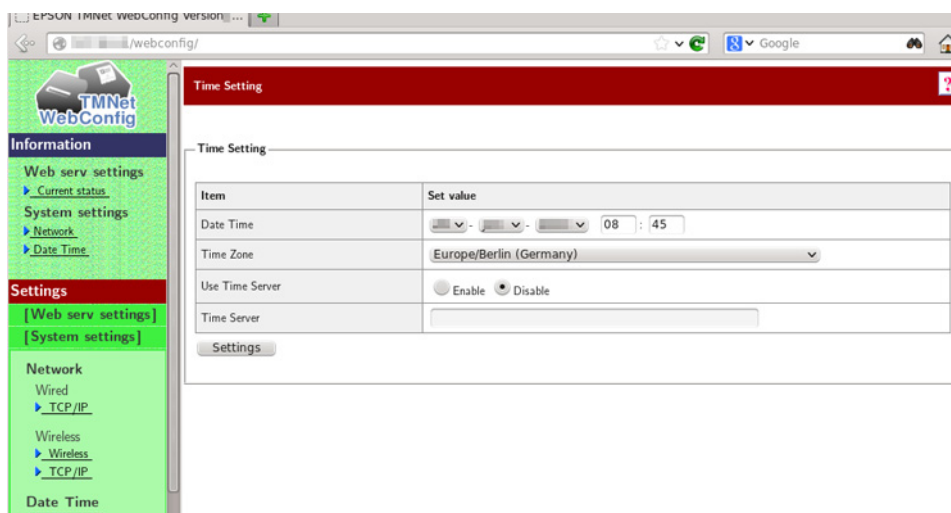

Item	Description
Date Time	Sets the time.
Time Zone	Sets the area. Sets the time difference from Coordinated Universal Time.
Use Time Server	Selects whether to use a time server.
Time Server	Specifies the URL for the time server.
Settings	Registers the settings with this product.

Settings - Admin settings - Save/restore settings

Saves and restores various settings for this product.

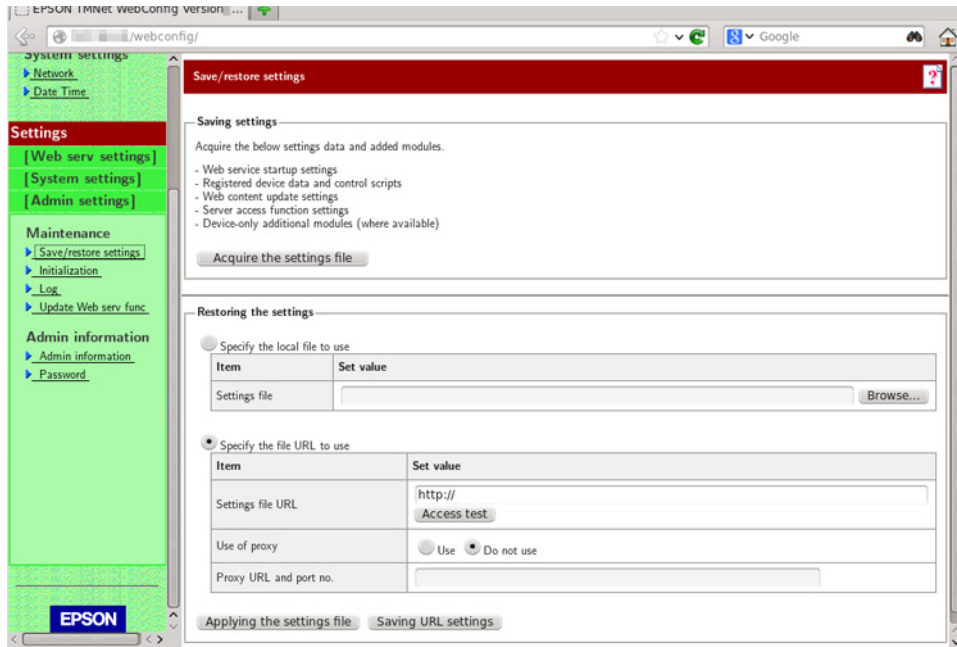

Item		Description
Acquire the settings file		Acquires the settings file for this product.
Specify the local file to use	Settings file	Specify the location of the local settings file.
Specify the file URL to use	Settings file URL	Specify the URL of the settings file.
	Use of proxy	Set whether you are using a proxy server or not.
	Proxy URL and port no.	Set the proxy URL and port number.
Applying the settings file		Applies the settings file.
Saving URL Settings		Saves the setting file URL and proxy settings.

Restored items

Items to be restored in the [Restore the settings] are as follows.

Item			Saved / Not Saved
Wired	TCP/IP Settings (Wired)	<ul style="list-style-type: none"> • Get IP Address • IP address • Subnet Mask • Default Gateway • Acquire DNS Server Address Automatically • DNS Server Address 	Not Saved
Wireless	Wireless Setting	<ul style="list-style-type: none"> • Network Mode • SSID • Authentication Method • Security Mode • Default WEP Key • WEP Key • WPA/WPA2 Pre-Shared Key 	Not Saved
	TCP/IP Settings (Wireless)	<ul style="list-style-type: none"> • Get IP Address • IP address • Subnet Mask • Default Gateway • Acquire DNS Server Address Automatically • DNS Server Address 	Not Saved
Date Time	Time Setting	<ul style="list-style-type: none"> • Date time • Time Zone • Automatically adjust clock for Day light Saving Time • Use Time Server • Time Server 	Not Saved
Maintenance	Save/restore settings	<ul style="list-style-type: none"> • Specify the local file to use/Specify the file URL to use • Settings file URL • Use of proxy • Proxy URL and port no. 	Saved
	Update Web service function	<ul style="list-style-type: none"> • Specify the local file to use/Specify the file URL to use • Settings file URL • Use of proxy • Proxy URL and port no. 	Saved

Item			Saved / Not Saved
Admin Information	Administrator information	<ul style="list-style-type: none">• Administrator name• Installation location	Saved
	Password	<ul style="list-style-type: none">• Password	Not Saved

Settings - Admin settings - Initialization

Initializes the Web service settings for this product.

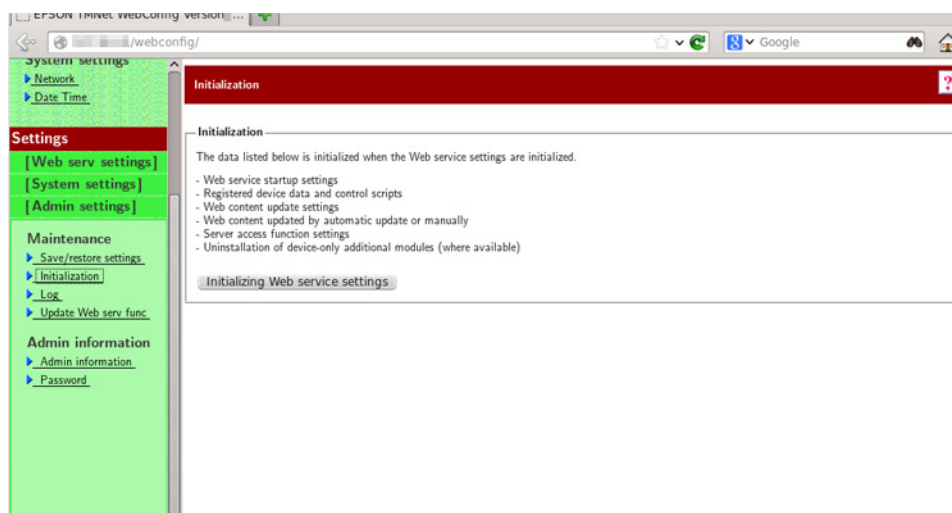

Item	Description
Initializing Web service settings	Initializes the Web service settings.

CAUTION

If you initialize the Web service, the password for EPSON TMNet WebConfig will also be initialized.

The initial values are below.

User name: epson

Password: epson

Settings - Admin settings - Log

Acquires this product's log file.

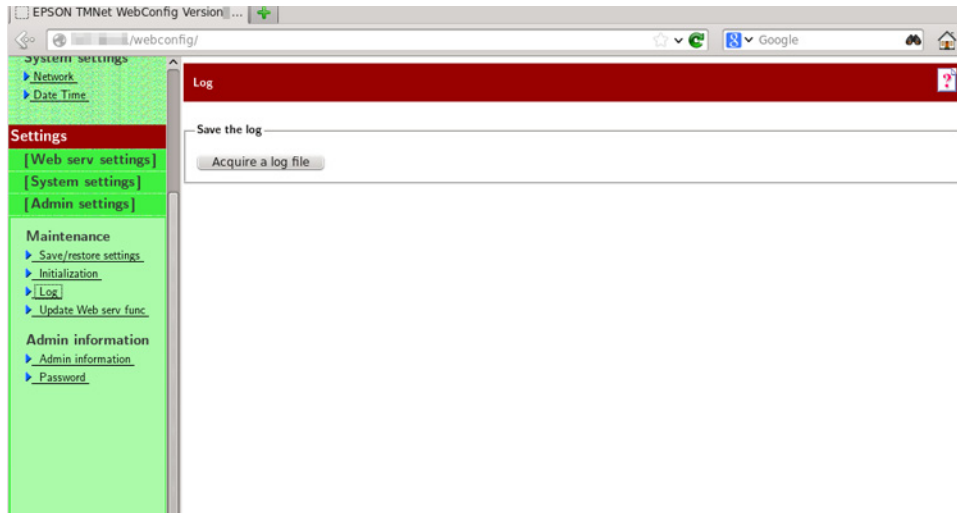

Item	Description
Acquire a log file	Acquires this product's log file.

Settings - Admin settings - Update Web service function

Updates the Web service function used in this product.

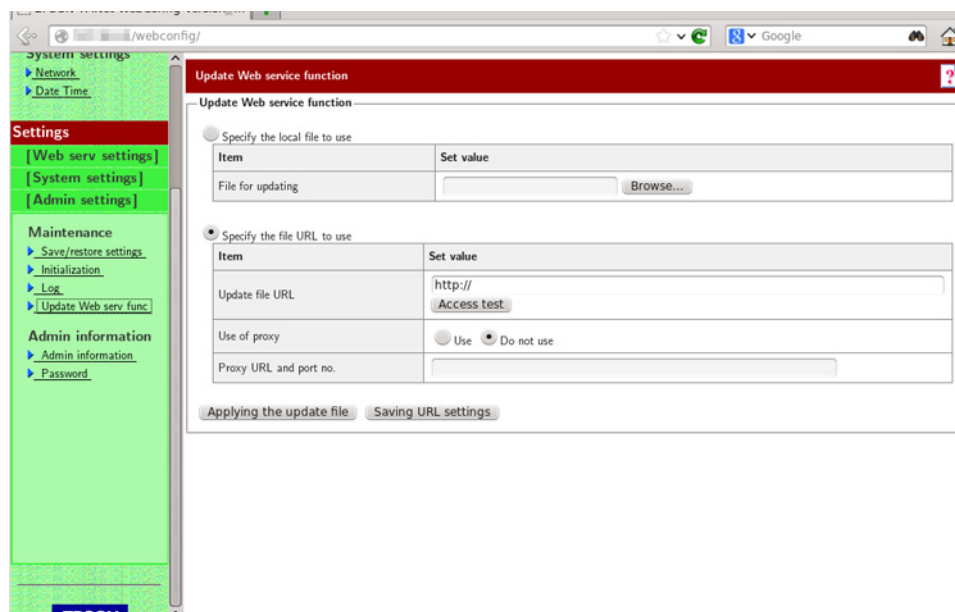

Item		Description
Specify the local file to use	File for updating	Specify the local file for updating.
Specify the file URL to use	Update file URL	Specify the URL of the file for updating.
	Use of proxy	Set whether you are using a proxy server or not.
	Proxy URL and port no.	Set the proxy URL and port number.
Applying the update file		Applies the update file.
Saving URL Settings		Saves the URL settings for the Web service function.

Settings - Admin settings - Admin information

Sets the administrator information for this product.

The screenshot shows a web browser window with the URL `/webconfig/`. The page title is "Administrator information". The sidebar on the left contains the following menu items:

- Information
 - Web serv settings
 - Current status
 - System settings
 - Network
 - Date Time
- Settings
 - Web serv settings
 - System settings
 - Admin settings
- Maintenance
 - Save/restore settings
 - Initialization
 - Log
 - Update Web serv func
- Admin information
 - Admin information
 - Password

The main content area contains a table with the following structure:

Item	Set value
Administrator name	<input type="text"/>
Installation location	<input type="text"/>

Below the table is an "OK" button.

Item	Description
Administrator name	Set the administrator.
Installation location	Set the installation location.
OK	Sends the settings to this product.

Settings - Admin settings - Password

Sets the password for this utility.

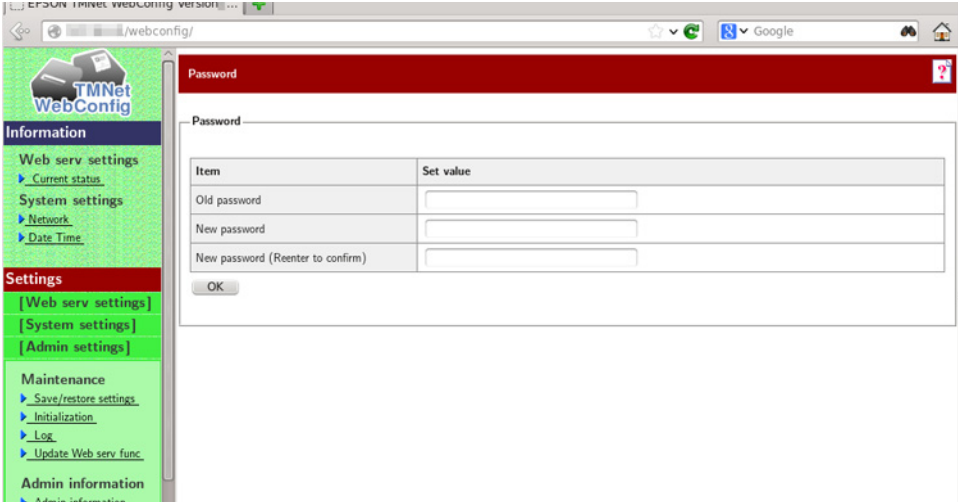

Item	Description
Old password	Input the current password.
New password	Input the new password.
New password (Reenter to confirm)	For confirmation, input the new password again.
OK	Registers the set password on this product.

CAUTION After setting the password, you will be asked for your user name and password on the certification screen displayed when this utility starts. Input "epson" for the user name and input the set password for the password. The initial value for the password is "epson".

TM-T70II Utility

This TM-T70II Utility is provided as a utility for setting this product's printer. You can set the following.

CAUTION

Start the TM-T70II Utility by using the same Windows computer on the same network as this product. When specifying settings, check that this printer and the computer used for specifying settings are connected to the same network.

- Storing Logos
- Coupon settings
- Paper Reduction settings
- Automatic Paper Cut settings
- Printing Control settings
- Font settings
- Option Buzzer settings
Not used in this product.
- Communication Interface settings
Not used in this product.
- Backup / Restore

For details about how to use TM-T70II Utility, refer to the TM-T70II Utility User's Manual.

Application Development Information

This chapter explains the control method for printers and necessary information for developing applications that use this product.

Development Information for Each System

TM-T70II-DT application development information varies based on the system.

- PC-POS System
- ePOS-Device API
- ePOS-Device XML
- Virtual environments system

Download

Drivers, utilities, and manuals can be downloaded from one of the following URLs.

For customers in North America, go to the following web site:

<http://www.epsonexpert.com/> and follow the on-screen instructions.

For customers in other countries, go to the following web site:

<http://www.epson-pos.com/>

PC-POS System Development Information

This system uses the same development environment as a Linux PC.

Interfaces and External Devices

Category	Device	Interface	Description
Printer	TM-T70II-DT (This product's printer)	USB	Recognized as a USB-connection TM-T70II. The printer name is "TM-T70II". The device file is /dev/usb/lp(0-9).
	TM printer	USB	For details, refer to the CUPS driver manual.
	TM printer	network	For details, refer to the CUPS driver manual.
Cash drawer	-	Drawer	Recognized as connected to this TM-T70II.
Customer display	DM-D110 (Dedicated Model)	USB	Connect a USB to access from the following device file. *1 /dev/DM-D110-USB
	DM-D110-USB (USB)		
	DM-D110/210/ 500 (serial)	Serial	Customer display connected via the serial interface. You can access from the following device. /dev/ttyS0
USB communication device	Barcode reader, etc.	USB	For a USB serial device, a device file is created in one of the /dev/tty/USB* directories. For a USB HID device, a device file is created in one of the /dev/input/event* directories. Refer to the corresponding device manual for other USB devices.
Serial communication device	-	Serial	For more on settings, refer to each device's manual.
Display	-	VGA	Used in operating the application. For more on settings, refer to each device's manual.

*1:For detail, refer to "[Linux command control](#)" on page 137.

*2: The number starts at zero ("0") and increases accordingly in order as devices are connected.

Linux command control

This section describes information for controlling devices using Linux commands.

TM-T70II-DT (This product's printer)

"TM-T70II" is specified as the name of the built-in printer by CUPS.

The CUPS driver specifies "TM-T70II" as the printer name and it is specified as the default printer. The following two commands are equivalent if printing by specifying the internal printer.

- `# lpr -PTM-T88V sample.txt`
- `#lpr sample.txt`

(Print "sample.txt")

The internal printer can also be accessed from the following device file.

- `/dev/USB/lp0`

Using example

```
# echo "testABCD" > /dev/usb/lp0
```

(The character string "testABCD" is sent to the printer.)

Others Printer

Specify the printer name by using the CUPS driver.

The TM printer can also be accessed from the following device file.

- `/dev/USB/lp1*`

The number starts at one ("1") and increases accordingly in order as devices are connected.

DM-D110 (Dedicated Model) / DM-D110-USB

You can access from the following device when only one DM-D110 unit is connected.

- /dev/DM-D110-USB

Using example

```
# echo "testABCD" > /dev/DM-D110-USB  
("testABCD" is displayed by the DM-D110.)
```

When a DM-D110 is connected, it is mounted to one of /dev/ttyUSB* directories as a virtual serial device, and a symbolic link designated as /dev/DM-D110-USB is created for the device file of the mounted virtual serial device.

/dev/ttyUSB* directories are mounted with any virtual serial device, not limited to DM-D110. If two DM-D110 (Dedicated Model) printers are connected, the last connected device is mounted to /dev/DM-D110-USB. In such cases, you can directly the first device from /dev/ttyUSB0.

Control Method for Devices

The following are methods for controlling devices.

- ESC/POS command:
This can control the EPSON TM printer, cash drawer, and customer display. (For details, refer to ["ESC/POS command" on page 139.](#))
- CUPS (Common Unix Printing System):
This is a Linux printer driver for use with Epson TM printers.
The driver controls paper cut , buzzer and cash drawer.
You cannot use any other customer display except for the DM-D110 (Dedicated Model). This driver has been installed in this product.
- JavaPOS ADK:
JavaPOS is the standard specification which defines an architecture and device interface (API) to access various POS devices from a Java based system. Using JavaPOS standard API allows control with Javabased applications of functions inherent to each device. A flexible design with Java language and JavaPOS enables many different types of computer sys-tems, such as stand alone or network configura-tion, to use a same application. You can use JavaPOS to build applications and drivers inde-pendently of platforms. This allows flexible configurations using thin clients to meet the system requirements.

ESC/POS command

ESC/POS is the Epson original printer command system. With ESC/POS commands, you can directly control all the TM printer functions, but detailed knowledge of printer specifications or combination of commands is required, compared to using a driver.

To use ESC/POS commands, you need to agree to a nondisclosure contract first and obtain the ESC/POS Application Programming Guide. Ask your dealer for details.

The ESC/POS command functions are listed below. See the ESC/POS Application Programming Guide for more details.

ESC/POS command functions

Commands for printing
Print and line feed
Print and feed <i>n</i> lines
Print data in page mode
Print and return to standard mode (in page mode)
Commands for line spacing
Set line spacing
Select default line spacing
Commands for print character
Select character code table
Select an international character set
Set right-side character spacing
Set all character fonts and styles
Turn underline mode on/off
Turn emphasized mode on/off
Select character font
Select character size
Turn smoothing mode on/off
Turn upside-down print mode on/off
Turn white/black reverse print mode on/off
Set character fonts and styles

Select/cancel user-defined character set
Define/delete user-defined characters
Cancel print data in page mode
Commands for panel buttons
Enable/disable panel buttons
Commands for paper sensors
Select paper sensor(s) to stop printing
Select paper sensor(s) to output paper-end signals
Commands for print positions
Horizontal tab
Set horizontal tab positions
Set left margin
Set print area width
Select justification
Set absolute print position
Set relative print position
Set print area in page mode
Select print direction in page mode
Set absolute vertical print position in page mode
Set relative vertical print position in page mode
Commands for bit image
Transmit the NV graphic memory capacity
Print the graphics data in the print buffer
Transmit the remaining amount of NV graphics
Transmit the key code list for defined NV graphics
Delete the specified NV graphics data
Define the NV graphics data
Print the specified NV graphics data
Store the graphics data in the print buffer
Select bit-image mode

Define downloaded bit image
Print downloaded bit image
Define the BMP in the NV graphics memory
Define downloaded BMP NV graphics
Commands for status
Enable/disable Automatic Status Back (ASB)
Transmit status
Transmit real-time status
Commands for barcode
Print barcode
Set barcode height
Set barcode width
Select print position of HRI characters
Select font for HRI characters
Commands for two-dimensional codes
PDF417: Set the number of columns in the data region
PDF417: Set the number of rows
PDF417: Set the width of module
PDF417: Set the row height
PDF417: Set the error correction level
PDF417: Select the options
PDF417: Store the data in the symbol storage area
PDF417: Print the symbol data in the symbol storage area
PDF417: Transmit the size information of the symbol data in the symbol storage area
QR Code: Select the model
QR Code: Set the size of module
QR Code: Select the error correction level
QR Code: Store the data in the symbol storage area
QR Code: Print the symbol data in the symbol storage data area
QR Code: Transmit the size information of the symbol data in the symbol storage area

MaxiCode: Select the mode
MaxiCode: Store the data in the symbol storage area
MaxiCode: Print the symbol data in the symbol storage area
MaxiCode: Transmit the size information of the symbol data in the symbol storage area
Two-dimensional GS1 DataBar: Set the width of module
Two-dimensional GS1 DataBar: Set the maximum width of GS1 DataBar Expanded Stacked
Two-dimensional GS1 DataBar: Store the data in the symbol storage area
Two-dimensional GS1 DataBar: Print the symbol data in the symbol storage area
Two-dimensional GS1 DataBar: Transmit the size information of the symbol data in the symbol storage area
Composite Symbology: Set the width of module
Composite Symbology: Set the maximum width of GS1 DataBar Expanded Stacked
Composite Symbology: Select font for HRI characters
Composite Symbology: Store the data in the symbol storage area
Composite Symbology: Print the symbol data in the symbol storage area
Composite Symbology: Transmit the size information of the symbol data in the symbol storage area
Commands for mechanical control
Select cut mode and cut paper
Commands for customization
Set the customized setting values
Transmit the customized setting values
Set the configuration item for the serial interface
Transmit the configuration item for the serial interface
Delete the specified record of NV user memory
Store the data in the specified record of NV user memory
Transmit the data in the specified record of NV user memory
Transmit capacity of the NV user memory currently being used
Transmit the remaining capacity of the NV user memory
Transmit the key code list of the records stored in the NV user memory
Delete all data in the NV user memory

Commands for sub-functions
Initialize printer
Transmit printer ID
Set horizontal and vertical motion units
Select peripheral device
Generate pulse to drawer
Generate pulse to drawer in real-time
Execute power-off sequence
Clear buffer(s)
Enable/disable real-time command
Send real-time request to printer
Select page mode
Select standard mode
Set the process ID response
Execute test print
Select the print speed
Select the number of parts for the thermal head energization
Initialize maintenance counter
Transmit maintenance counter

ePOS-Device API

The following explains the items required to develop a system that uses ePOS-Device API. For details about ePOS-Device API, refer to the ePOS-Device API User's Manual.

NOTE

You can download the latest version of ePOS-Device and update the device.

External Devices

The following is information as of May, 2013. For the latest information, refer to the ePOS-Device API User's Manual.

Printer

- TM-T70II-DT: This product's printer
- Network printer: TM printer connected to the same network as this product. Applicable models:
 - TM-T88V
 - TM-T70
 - TM-T70II
 - TM-T90
 - TM-L90

CAUTION

TM printers connected to this product via USB interface cannot be used.

Cash drawer

Recognized as connected to this product's printer.

Customer display

- DM-D110 (Dedicated Model)

CAUTION

Other customer displays connected to this product via USB or serial interface cannot be used.

Key input device

Device with the device control script prepared in advance

- MSR
- barcode scanner
- USB keyboard device

You must acquire the device control script files for the following devices

- Input device that can operate with the OS standard HID driver

Serial communication device

You must acquire the device control script files for the following devices

- Serial communication device that can operate with the OS standard serial communication driver:
A separate serial-USB conversion driver is necessary.
- USB devices that can be controlled the same as a serial communication device

Other devices

These can be used if you create a device control script file and register the device.

Application Information

Web applications

Register (install) a Web application (contents) that uses ePOS-Device API in any of the following Web servers.

- TM-T70II-DT Web server
- Web server in the network
- Web server via the Internet

If registering a Web application on the TM-T70II-DT, use EPSON TMNet WebConfig to register it.

Device control

Specify a device ID for each device. The initial value for the device ID for this product's printer is "local_printer".

You do not need to specify one for DM-D110 (dedicated model). Device ID for the dedicated customer display is fixed to "local_display".

Make the device control setting with EPSON TMNet WebConfig.

ePOS-Device XML

The following explains the items required to develop a system that uses ePOS-Device XML. For details about ePOS-Device XML, refer to the ePOS-Device XML User's Manual.

NOTE

You can download the latest version of ePOS-Device and update the device.

External Devices

The following is information as of May, 2013. For the latest information, refer to the ePOS-Device XML User's Manual.

Printer

- TM-T70II-DT: This product's printer
- Network printer: TM printer connected to the same network as this product.
Applicable models:
 - TM-T88V
 - TM-T70
 - TM-T70II
 - TM-T90
 - TM-L90

CAUTION

TM printers connected to this product via USB cannot be used.

Cash drawer

Recognized as connected to this product's printer.

Customer display

- DM-D110 (Dedicated Model)

CAUTION

Other customer displays connection to this product via USB or serial cannot be used.

Key input device

Device with the device control script prepared in advance

- MSR
- Barcode scanner
- USB keyboard device

You must acquire the device control script files for the following devices

- Input device that can operate with the OS standard HID driver

Serial communication device

You must acquire the device control script files for the following devices

- Serial communication device that can operate with the OS standard serial communication driver:
A separate serial-USB conversion driver is necessary.
- USB devices that can be controlled the same as a serial communication device

Other devices

These can be used if you create a device control script file and register the device.

Application Information

Environment that can use socket communication and can handle XML documents

- ❑ Examples: iOS / Android / Windows CE / Windows / Linux / Mac OS, etc.
- ❑ Java, .NET Framework

Device control

Specify a device ID for each device. The initial value for the device ID for this product's printer is "local_printer".

You do not need to specify one for DM-D110 (dedicated model). Device ID for the dedicated customer display is fixed to "local_display".

Make the control setting with EPSON TMNet WebConfig.

Setting/Checking Modes

Besides the normal print mode, the printer has the following modes to set or check settings of the printer.

- Self-test Mode
- Hexadecimal Dumping Mode
- NV Graphics Print Mode
- Receipt Enhancement Information Print Mode
- Memory Switch Setting Mode

Self-test Mode

You can confirm the following information by running the self-test mode.

- Control software version
- Receive buffer size
- Busy conditions
- Built-in character sets
- Print density
- Maintenance Information (Print head running length, count of autocutting)

Follow the steps below to run this mode.

- 1** Close the roll paper cover.
- 2** While pressing the Feed button, turn on the printer. (Keep pressing the Feed button until the printer starts printing.)
The printer starts printing the current status of the printer.
When the printer finishes printing the printer status, the following message is printed and the Paper LED flashes. (The printer is now in the self-test wait mode.):

```
"Select Modes by pressing Feed button.
Continue SELF-TEST: Less than 1 second
Mode Selection      : 1 second or more"
```
- 3** Press the Feed button while the printer is in the self-test wait mode.
If you select SELF-TEST, the printer prints a rolling pattern using only the built-in character set.
If you select the mode selection, follow the instructions printed by the printer.

After printing the following message, the printer is initialized and returns to the normal mode.

```
"*** completed***"
```

Hexadecimal Dumping Mode

In the hexadecimal dumping mode, the printer prints the data transmitted from a host computer in hexadecimal numbers and their corresponding characters.

Follow the steps below to run this mode.

CAUTION

- If there is no character corresponding to print data, "." is printed.
- If print data is less than one line, press the Feed button to print the line.
- Applications that confirm printer status may not work correctly during the hexadecimal dumping mode. The printer returns only the status for "Transmit real-time status."

- 1** Open the roll paper cover.
- 2** While pressing the Feed button, turn on the printer.
- 3** Close the roll paper cover.

The printer starts printing data received from then on in hexadecimal numbers and their corresponding characters.

Print example:

```
Hexadecimal Dump
To terminate hexadecimal dump,
press FEED button three times.

1B 21 00 1B 26 02 40 40 1B 69 . ! . . & . @ @ . i
1B 25 01 1B 63 34 00 1B 30 31 . % . . c 4 . . 0 1
41 42 43 44 45 46 47 48 49 4A A B C D E F G H I J

*** completed ***
```

Turn off the printer or press the Feed button three times to return to the normal mode.

NV Graphics Print Mode

You can confirm the following information by running NV graphics print mode:

- Capacity of the NV graphics
- Used amount of the NV graphics
- Unused capacity of the NV graphics
- Number of NV graphics that are registered
- Key code, number of dots in X direction, number of dots in Y direction, number of colors to be defined.
- NV graphics data

NOTE

For detailed information about NV graphics, see ["NV Graphics Memory" on page 29](#).

Follow the steps below to run this mode.

- 1** Close the roll paper cover.
- 2** While pressing the Feed button, turn on the printer. (Keep pressing the Feed button until the printer starts printing.)
The printer starts printing the current status of the printer.
- 3** After the printing has been completed, press the Feed button for more than one second.
The printer starts printing instructions.
- 4** After the printing has been completed, press the Feed button.
- 5** Press the Feed button for more than one second.

Turn the power off and on to return to the normal mode.

Receipt Enhancement Information Print Mode

You can confirm the following information by running the receipt enhancement (R/E) information mode:

- Automatic top logo setting
- Automatic bottom logo setting
- Extended settings for automatic top/bottom logo

Follow the steps below to run this mode.

- 1** Close the roll paper cover.
- 2** While pressing the Feed button, turn the power on. (Keep pressing the Feed button until the printer starts printing.)
The printer prints the current status of the printer.
- 3** After the printing has been completed, press the Feed button for more than one second.
The printer starts printing instructions.
- 4** After the printing has been completed, press the Feed button twice.
- 5** Then press the Feed button for more than one second.

Turn the power off and on to return to the normal mode.

Memory Switch Setting Mode

You can configure the memory switches of the printer.

- Receive buffer capacity
- Processing when data receive error
- USB power-saving function
- Error signal output
- Multi-tone print density
- Character code table default
- Interface selection
- Auto paper reduction
- Buzzer control
- BUSY condition
- Auto line feed
- Release condition of receive buffer BUSY
- Print density
- Print speed
- International character default
- Autocutting after closing cover
- Font auto replacement
- Communication condition of USB interface

NOTE

For detailed information about memory switches (customized value), see "[Setting the Memory Switches/Receipt Enhancement](#)" on page 85.

Follow the steps below to run this mode.

- 1** Close the roll paper cover.
- 2** Turn on the product while pressing the Feed button. (Keep pressing the Feed button until the printer starts printing.)
The printer prints current status of the product.
- 3** After the printing has been completed, press the Feed button for more than one second.
The printer starts printing instructions.
- 4** After the printing has been completed, press the Feed button three times.
- 5** Then press the Feed button for more than one second.
The printer starts printing instructions for settings. Follow the instructions.

After one setting has been completed, the printer stores the setting and then starts initializing. After that, the printer returns to the normal mode.



Handling

This chapter explains how to handle the TM-T70II-DT.

Turning the Power On/Off

Turning the Power On

Use the power button to turn on the power for this product. You can also turn on the power via the network.

Turning the Power Off

Use the power button to turn off the power for this product.
By default, the OS shuts down when the power button is pressed.

Forced Termination

If you cannot turn this product off using applications or the OS, you can execute forced termination as a last resort. Keep pressing the power button for approximately 4 seconds until this product is turned off. Be careful; when forced termination is executed, all unsaved data is lost.

Printer Operation

Printer Reset

Press the printer reset button with a pointed object (such as a pen) to reset the printer unit.

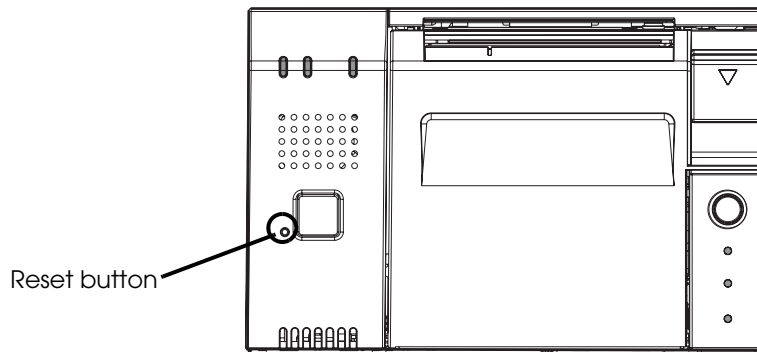

Setting and Replacing Roll Paper



- **Do not open the roll paper cover during printing.**
Doing so may damage the printer.
- **Do not touch the manual cutter when installing or replacing roll paper.**
Because the manual cutter is sharp, you may injure yourself.



- Use roll paper that fits the printer specifications. For details about paper specifications, refer to ["Paper Specifications" on page 37](#).
- Do not use a type of roll paper of which the roll paper is glued to the core.

1 Press the cover open Lever to open the roll paper cover.

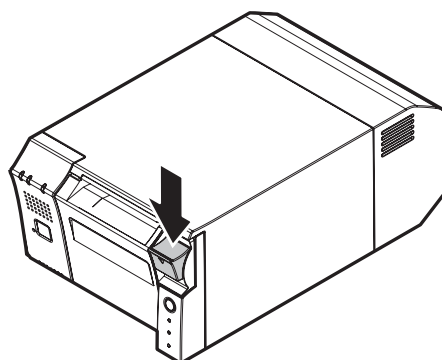

If you cannot open the roll paper cover, refer to ["Removing Jammed Paper" on page 160](#).

- 2** If there is a used roll paper core, remove it.
- 3** Be careful of the rolling direction, and set the roll paper in the printer.

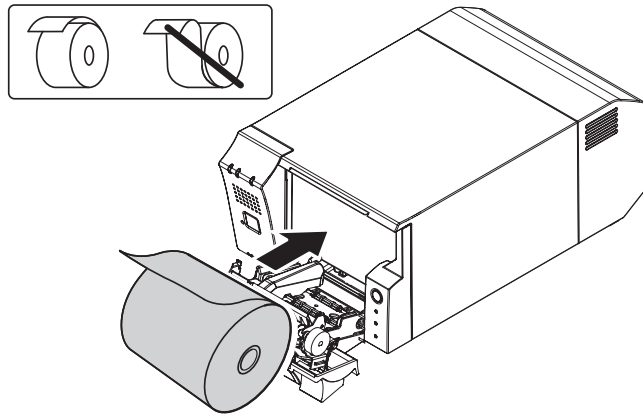

- 4** Pull the roll paper out towards you, and close the roll paper cover.

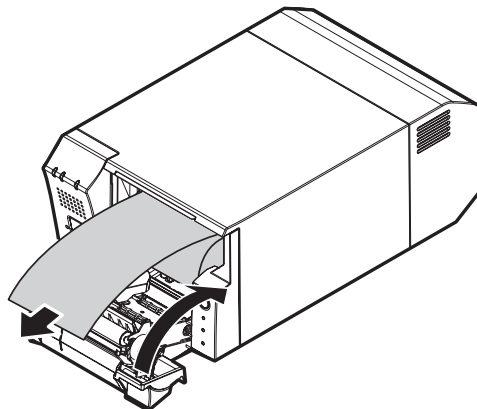

- 5** Cut the end of the roll paper using the manual cutter.

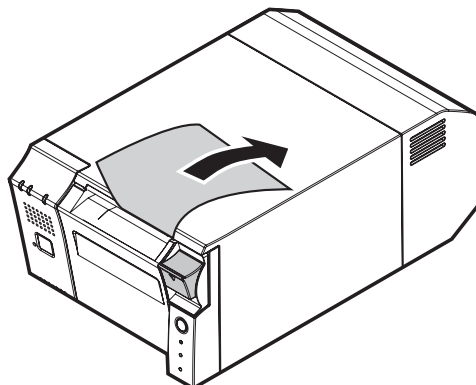

Removing Jammed Paper

When a paper jam occurs, never pull out the paper forcibly. Open the roll paper cover and remove the jammed paper.



Do not touch the thermal head (See "[Cleaning the Thermal Head](#)" on page 161.) **because it can be very hot after printing.**

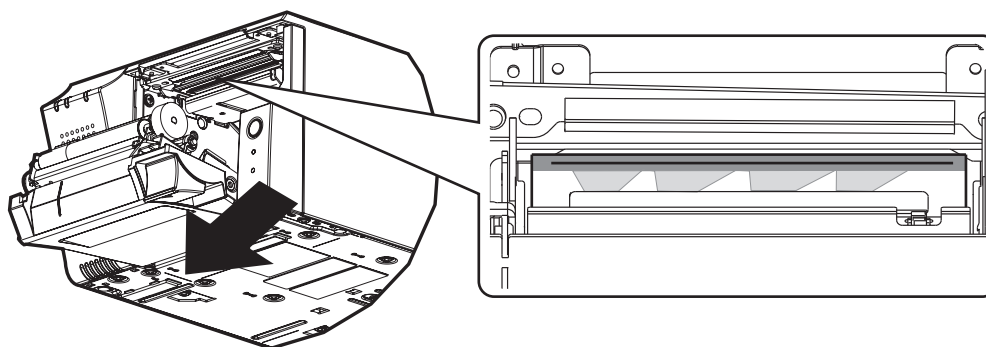

Adjusting the Speaker Volume

You can adjust the speaker volume with the speaker volume adjustment function of the OS included in the TM-T70II-DT.

Cleaning the Case

Turn off the printer before cleaning the case, and wipe the dirt off the case with a dry or slightly damp cloth. If it is very dirty, soak a cloth in a neutral liquid detergent, tightly wring it out, and wipe the dirt away.

CAUTION

Never clean the product with alcohol, benzene, thinner, or other such solvents. Doing so may damage or break the parts made of plastic and rubber.

Cleaning the Thermal Head

Epson recommends cleaning the thermal head periodically (generally every 3 months) to maintain the receipt print quality.



After printing, the thermal head can be very hot. Do not touch it and let it cool before you clean it. Do not damage the thermal head by touching it with your fingers or any hard object.

Turn off the printer, open the roll paper cover, and clean the thermal elements of the thermal head with a cotton swab moistened with an alcohol solvent (ethanol or IPA).

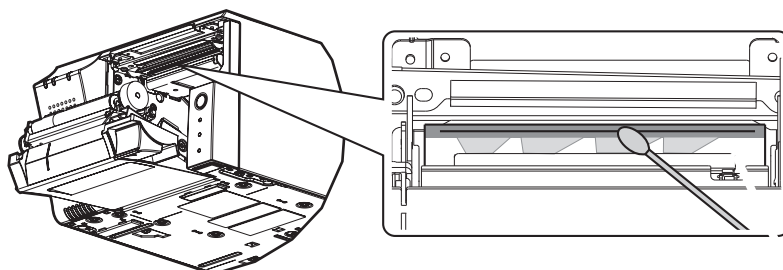

Depending on the roll paper used, paper dust may stick to the platen roller and roll paper end sensor. To remove the paper dust, clean the platen roller and roll paper end sensor with a cotton swab slightly moistened with water. Turn on the printer power only after the water has completely dried.

Connecting to External Devices

When connecting an external device to the interface unit, follow the procedures below.



When connecting an external device to a USB connector, be sure to check this product and the device's manual for the amount of power consumed by the external device.

- 1 Connect all the cables to the connectors on the back of the printer.

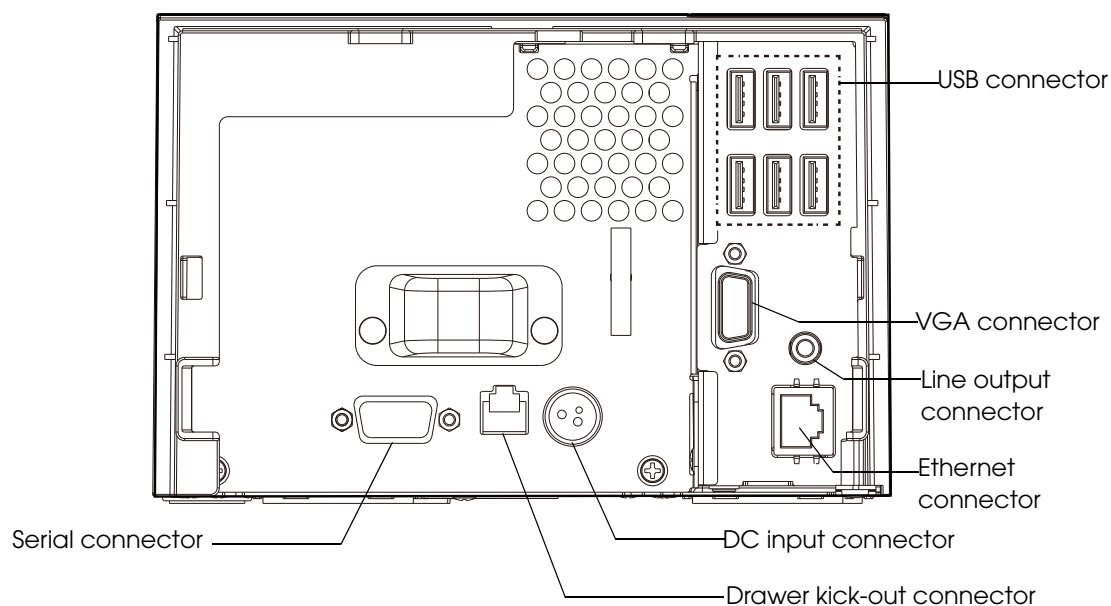

- 2 Connect the other cable connectors to the external devices.

Preparing for Transport

Follow the steps below to transport the product.

- 1** Turn off the product.
- 2** Remove the peripherals and the power connector.
- 3** Remove the roll paper.
- 4** Remove the customer display.
- 5** Pack the product upright.



Appendix

Character Code Tables

CAUTION

- The character code tables show only character configurations. They do not show the actual print pattern.
- "SP" in the table shows a space.

Common to All Pages

When International character set (See ["International Character Sets" on page 209.](#)) is USA:

HEX	0	1	2	3	4	5	6	7
0	NUL 00	DLE 16	SP 32	0 48	@ 64	P 80	` 96	p 112
1		XON 17	! 33	1 49	A 65	Q 81	a 97	q 113
2			" 34	2 50	B 66	R 82	b 98	r 114
3		XOFF 19	# 35	3 51	C 67	S 83	c 99	s 115
4	EOT 04	DC4 20	\$ 36	4 52	D 68	T 84	d 100	t 116
5	ENQ 05	NAK 21	% 37	5 53	E 69	U 85	e 101	u 117
6	ACK 06		& 38	6 54	F 70	V 86	f 102	v 118
7			' 39	7 55	G 71	W 87	g 103	w 119
8		CAN 24	(40	8 56	H 72	X 88	h 104	x 120
9	HT 09) 41	9 57	I 73	Y 89	i 105	y 121
A	LF 10		* 42	: 58	J 74	Z 90	j 106	z 122
B		ESC 27	+ 43	; 59	K 75	[91	k 107	{ 123
C	FF 12	FS 28	, 44	< 60	L 76	¥ 92	l 108	 124
D	CR 13	GS 29	- 45	= 61	M 77] 93	m 109	} 125
E		RS 30	. 46	> 62	N 78	^ 94	n 110	~ 126
F			/ 47	? 63	O 79	_ 95	o 111	SP 127

HEX	8	9	A	B	C	D	E	F
0	Ç 128	É 144	á 160	☐ 176	Ł 192	⌌ 208	α 224	≡ 240
1	ü 129	æ 145	í 161	☐ 177	⌞ 193	⌘ 209	β 225	± 241
2	é 130	Æ 146	ó 162	☐ 178	⌟ 194	⌡ 210	Γ 226	≥ 242
3	â 131	ô 147	ú 163	 179	⌠ 195	⌢ 211	π 227	≤ 243
4	ä 132	ö 148	ñ 164	⌡ 180	— 196	⌣ 212	Σ 228	∫ 244
5	à 133	ò 149	Ñ 165	⌢ 181	⌤ 197	⌤ 213	σ 229	∫ 245
6	å 134	û 150	ä 166	⌣ 182	⌥ 198	⌥ 214	μ 230	÷ 246
7	ç 135	ù 151	º 167	⌤ 183	⌦ 199	⌦ 215	τ 231	≈ 247
8	ê 136	ÿ 152	¿ 168	⌥ 184	⌧ 200	⌧ 216	Φ 232	° 248
9	ë 137	Ö 153	Г 169	⌧ 185	⌨ 201	⌨ 217	Θ 233	• 249
A	è 138	Ü 154	Г 170	⌨ 186	〈 202	〈 218	Ω 234	· 250
B	ï 139	ç 155	½ 171	〈 187	〉 203	■ 219	δ 235	√ 251
C	î 140	£ 156	¼ 172	〉 188	⌫ 204	■ 220	∞ 236	ⁿ 252
D	ì 141	¥ 157	ı 173	⌫ 189	= 205	■ 221	Φ 237	² 253
E	Ä 142	Pt 158	« 174	⌫ 190	⌬ 206	■ 222	ε 238	■ 254
F	Å 143	f 159	» 175	⌬ 191	⌭ 207	■ 223	∩ 239	SP 255

Page 1 (Katakana)

HEX	8	9	A	B	C	D	E	F
0	ー 128	㇇ 144	SP 160	ー 176	々 192	ミ 208	= 224	㇇ 240
1	■ 129	㇈ 145	。 161	ア 177	チ 193	ム 209	㇈ 225	円 241
2	■ 130	㇉ 146	「 162	イ 178	ツ 194	メ 210	㇉ 226	年 242
3	■ 131	㇊ 147	」 163	ウ 179	㇊ 195	モ 211	㇊ 227	月 243
4	■ 132	ー 148	、 164	エ 180	ト 196	ヤ 212	▲ 228	日 244
5	■ 133	ー 149	・ 165	オ 181	ナ 197	ユ 213	▲ 229	時 245
6	■ 134	丨 150	ヲ 166	カ 182	ニ 198	ヨ 214	▼ 230	分 246
7	■ 135	丨 151	㇇ 167	キ 183	ヌ 199	㇇ 215	▼ 231	秒 247
8	丨 136	「 152	イ 168	ク 184	ネ 200	リ 216	♠ 232	千 248
9	丨 137	㇇ 153	ウ 169	ケ 185	ノ 201	ル 217	♥ 233	市 249
A	丨 138	㇈ 154	エ 170	コ 186	ハ 202	レ 218	♦ 234	区 250
B	丨 139	」 155	オ 171	サ 187	ヒ 203	ロ 219	♣ 235	町 251
C	丨 140	「 156	ヤ 172	シ 188	フ 204	ワ 220	● 236	村 252
D	丨 141	㇉ 157	ユ 173	ス 189	ヘ 205	ソ 221	○ 237	人 253
E	■ 142	㇊ 158	ヨ 174	セ 190	ホ 206	㇊ 222	/ 238	■ 254
F	㇈ 143	㇋ 159	㇇ 175	㇈ 191	マ 207	。 223	㇈ 239	SP 255









HEX	8	9	A	B	C	D	E	F
0	Ç 128	É 144	á 160	☐ 176	Ł 192	ð 208	Ó 224	- 240
1	ü 129	æ 145	í 161	☐ 177	⊥ 193	Ð 209	β 225	± 241
2	é 130	Æ 146	ó 162	☐ 178	⊥ 194	Ê 210	Ô 226	= 242
3	â 131	ô 147	ú 163	 179	† 195	Ë 211	Ò 227	¾ 243
4	ä 132	ö 148	ñ 164	‡ 180	— 196	È 212	õ 228	¶ 244
5	à 133	ò 149	Ñ 165	Á 181	† 197	ı 213	Õ 229	§ 245
6	å 134	û 150	ª 166	Â 182	ã 198	Í 214	μ 230	÷ 246
7	ç 135	ù 151	º 167	À 183	Ã 199	Î 215	þ 231	˘ 247
8	ê 136	ÿ 152	¿ 168	© 184	ℒ 200	Ï 216	ƒ 232	° 248
9	ë 137	Ö 153	® 169	‡ 185	℞ 201	Ɔ 217	Ú 233	¨ 249
A	è 138	Ü 154	¬ 170	 186	⊥ 202	ƒ 218	Û 234	· 250
B	ï 139	ø 155	½ 171	¶ 187	π 203	■ 219	Ù 235	¹ 251
C	î 140	£ 156	¼ 172	¶ 188	 204	■ 220	Ý 236	³ 252
D	ì 141	Ø 157	ı 173	¢ 189	= 205	ı 221	Ý 237	² 253
E	Ä 142	× 158	« 174	¥ 190	 206	Ï 222	— 238	■ 254
F	Å 143	f 159	» 175	‡ 191	α 207	■ 223	' 239	SP 255

Page 3 (PC860: Portuguese)

HEX	8	9	A	B	C	D	E	F
0	Ç 128	É 144	á 160	☐ 176	L 192	⌌ 208	α 224	≡ 240
1	ü 129	À 145	í 161	☐ 177	⊥ 193	⌌ 209	β 225	± 241
2	é 130	È 146	ó 162	☐ 178	⊥ 194	⌌ 210	Γ 226	≥ 242
3	â 131	ô 147	ú 163	 179	⊥ 195	⌌ 211	π 227	≤ 243
4	ã 132	õ 148	ñ 164	⊥ 180	— 196	⌌ 212	Σ 228	∫ 244
5	à 133	ò 149	Ñ 165	⊥ 181	⊥ 197	F 213	σ 229	∫ 245
6	Á 134	Ú 150	á 166	⌌ 182	⊥ 198	⌌ 214	μ 230	÷ 246
7	ç 135	ù 151	º 167	⌌ 183	⌌ 199	⌌ 215	τ 231	≈ 247
8	ê 136	Ì 152	¿ 168	⊥ 184	⌌ 200	⊥ 216	Φ 232	° 248
9	Ê 137	Õ 153	Ò 169	⌌ 185	⌌ 201	⌌ 217	Θ 233	• 249
A	è 138	Ü 154	¬ 170	⌌ 186	⌌ 202	⌌ 218	Ω 234	· 250
B	Í 139	ç 155	½ 171	⌌ 187	⌌ 203	■ 219	δ 235	√ 251
C	Ô 140	£ 156	¼ 172	⌌ 188	⌌ 204	■ 220	∞ 236	ⁿ 252
D	ì 141	Ù 157	í 173	⌌ 189	= 205	■ 221	Φ 237	² 253
E	Ã 142	Pt 158	« 174	⌌ 190	⌌ 206	■ 222	ε 238	■ 254
F	Â 143	Ó 159	» 175	⌌ 191	⌌ 207	■ 223	∩ 239	SP 255

HEX	8	9	A	B	C	D	E	F
0	Ç 128	É 144	ı 160	☐ 176	Ł 192	⌌ 208	α 224	≡ 240
1	ü 129	È 145	´ 161	☐ 177	⊥ 193	⌌ 209	β 225	± 241
2	é 130	Ê 146	ó 162	☐ 178	⊤ 194	⌌ 210	Γ 226	≥ 242
3	â 131	ô 147	ú 163	 179	⊥ 195	⌌ 211	π 227	≤ 243
4	Â 132	Ë 148	¨ 164	⊥ 180	— 196	⌌ 212	Σ 228	∫ 244
5	à 133	Ï 149	˙ 165	⊥ 181	⊥ 197	⌌ 213	σ 229	∫ 245
6	¶ 134	û 150	³ 166	⌌ 182	⌌ 198	⌌ 214	μ 230	÷ 246
7	ç 135	ù 151	— 167	⌌ 183	⌌ 199	⌌ 215	τ 231	≈ 247
8	ê 136	α 152	Î 168	⌌ 184	⌌ 200	⌌ 216	Φ 232	° 248
9	ë 137	Ô 153	⌌ 169	⌌ 185	⌌ 201	⌌ 217	Θ 233	• 249
A	è 138	Û 154	¬ 170	⌌ 186	⌌ 202	⌌ 218	Ω 234	· 250
B	ï 139	ϕ 155	½ 171	⌌ 187	⌌ 203	■ 219	δ 235	√ 251
C	î 140	£ 156	¼ 172	⌌ 188	⌌ 204	■ 220	∞ 236	ⁿ 252
D	= 141	Û 157	¾ 173	⌌ 189	= 205	■ 221	Φ 237	² 253
E	À 142	Û 158	« 174	⌌ 190	⌌ 206	■ 222	ε 238	■ 254
F	§ 143	f 159	» 175	⌌ 191	⌌ 207	■ 223	∩ 239	SP 255

Page 5 (PC865: Nordic)

HEX	8	9	A	B	C	D	E	F
0	Ç 128	É 144	á 160	 176	L 192	⌌ 208	α 224	≡ 240
1	ü 129	æ 145	í 161	 177	⌐ 193	⌑ 209	β 225	± 241
2	é 130	Æ 146	ó 162	 178	⌒ 194	⌒ 210	Γ 226	≥ 242
3	â 131	ô 147	ú 163	 179	⌓ 195	⌌ 211	π 227	≤ 243
4	ä 132	ö 148	ñ 164	⌔ 180	— 196	⌑ 212	Σ 228	∫ 244
5	à 133	ò 149	Ñ 165	⌕ 181	⌕ 197	⌑ 213	σ 229	∫ 245
6	å 134	û 150	ä 166	⌖ 182	⌕ 198	⌑ 214	μ 230	÷ 246
7	ç 135	ù 151	º 167	⌗ 183	⌕ 199	⌑ 215	τ 231	≈ 247
8	ê 136	ÿ 152	¿ 168	⌘ 184	⌌ 200	⌑ 216	Φ 232	° 248
9	ë 137	Ö 153	Г 169	⌙ 185	⌑ 201	⌑ 217	Θ 233	• 249
A	è 138	Ü 154	Г 170	⌚ 186	⌌ 202	⌑ 218	Ω 234	· 250
B	ï 139	ø 155	½ 171	⌛ 187	⌑ 203	 219	δ 235	√ 251
C	î 140	£ 156	¼ 172	⌜ 188	⌑ 204	 220	∞ 236	ⁿ 252
D	ì 141	Ø 157	ì 173	⌝ 189	= 205	 221	Φ 237	² 253
E	Ä 142	Pt 158	« 174	⌞ 190	⌑ 206	 222	ε 238	■ 254
F	Å 143	f 159	α 175	⌟ 191	⌌ 207	 223	∩ 239	SP 255







HEX	8	9	A	B	C	D	E	F
0	Ç 128	Ï 144	ï 160	☼ 176	Ł 192	Ƨ 208	ζ 224	- 240
1	ü 129	SP 145	ÿ 161	☼ 177	⊥ 193	Υ 209	η 225	± 241
2	é 130	Ŏ 146	ó 162	☼ 178	Ƨ 194	Φ 210	θ 226	υ 242
3	â 131	ô 147	ú 163	 179	Ƨ 195	Χ 211	ι 227	Φ 243
4	ä 132	ö 148	À 164	† 180	- 196	Ψ 212	κ 228	Χ 244
5	à 133	Υ 149	Β 165	Κ 181	† 197	Ω 213	λ 229	§ 245
6	Ä 134	Û 150	Γ 166	Λ 182	Π 198	α 214	μ 230	Ψ 246
7	ç 135	ù 151	Δ 167	Μ 183	Ρ 199	β 215	ν 231	ˆ 247
8	ê 136	Ω 152	Ε 168	Ν 184	ℒ 200	γ 216	ξ 232	° 248
9	ë 137	Ö 153	Ζ 169	‡ 185	Ɔ 201	Ɔ 217	ο 233	¨ 249
A	è 138	Ü 154	Η 170	‖ 186	⊥ 202	Γ 218	π 234	ω 250
B	ï 139	ά 155	½ 171	‡ 187	⊥ 203	■ 219	ρ 235	Û 251
C	î 140	£ 156	Θ 172	‡ 188	‡ 204	■ 220	σ 236	Ü 252
D	Έ 141	έ 157	Ι 173	≡ 189	= 205	δ 221	ς 237	ώ 253
E	Ä 142	ή 158	« 174	Ο 190	‡ 206	ε 222	τ 238	■ 254
F	Ή 143	ι 159	» 175	Γ 191	Σ 207	■ 223	' 239	SP 255

Page 12 (PC853: Turkish)

HEX	8	9	A	B	C	D	E	F
0	Ç 128	É 144	á 160	☐ 176	L 192	SP 208	Ó 224	- 240
1	ü 129	ć 145	í 161	☐ 177	⊥ 193	SP 209	β 225	SP 241
2	é 130	Ĉ 146	ó 162	☐ 178	⊥ 194	Ê 210	Ô 226	ł 242
3	â 131	ô 147	ú 163	 179	⊥ 195	Ë 211	Ò 227	ʰ 243
4	ä 132	ö 148	ñ 164	⊥ 180	- 196	È 212	Ĝ 228	˘ 244
5	à 133	ò 149	Ñ 165	Á 181	⊥ 197	ı 213	ğ 229	§ 245
6	ĉ 134	û 150	Ĝ 166	Â 182	Ŝ 198	Í 214	μ 230	÷ 246
7	ç 135	ù 151	ğ 167	À 183	ŝ 199	Î 215	℥ 231	˘ 247
8	ê 136	İ 152	Ĥ 168	Ş 184	℥ 200	İ 216	ħ 232	° 248
9	ë 137	Ö 153	ĥ 169	‡ 185	℥ 201	Ј 217	Ú 233	˘ 249
A	è 138	Ü 154	SP 170	 186	⊥ 202	Г 218	Û 234	˘ 250
B	ï 139	ĝ 155	½ 171	‡ 187	⊥ 203	■ 219	Ù 235	SP 251
C	î 140	£ 156	Ĵ 172	‡ 188	⊥ 204	■ 220	Û 236	³ 252
D	ì 141	Ĝ 157	ş 173	Ž 189	= 205	SP 221	ů 237	² 253
E	Ä 142	× 158	« 174	ž 190	‡ 206	İ 222	· 238	■ 254
F	Ĉ 143	ĵ 159	» 175	ƒ 191	α 207	■ 223	˘ 239	SP 255

HEX	8	9	A	B	C	D	E	F
0	Ç 128	É 144	á 160	☐ 176	Ł 192	◌ 208	Ó 224	- 240
1	ü 129	æ 145	í 161	☐ 177	⊥ 193	ª 209	β 225	± 241
2	é 130	Æ 146	ó 162	☐ 178	⊥ 194	Ê 210	Ô 226	SP 242
3	â 131	ô 147	ú 163	 179	† 195	Ë 211	Ò 227	¾ 243
4	ä 132	ö 148	ñ 164	‡ 180	– 196	È 212	õ 228	¶ 244
5	à 133	ò 149	Ñ 165	Á 181	† 197	€ 213	Õ 229	§ 245
6	å 134	û 150	Ǧ 166	Â 182	ã 198	Í 214	μ 230	÷ 246
7	ç 135	ù 151	ǧ 167	À 183	Ã 199	Î 215	SP 231	˘ 247
8	ê 136	İ 152	ı 168	© 184	ℒ 200	İ 216	× 232	° 248
9	ë 137	Ö 153	® 169	‡ 185	℞ 201	Ɔ 217	Ú 233	¨ 249
A	è 138	Ü 154	¬ 170	 186	⊥ 202	Ɔ 218	Û 234	· 250
B	ï 139	ø 155	½ 171	¶ 187	π 203	■ 219	Ù 235	¹ 251
C	î 140	£ 156	¼ 172	¶ 188	 204	■ 220	ì 236	³ 252
D	ı 141	Ø 157	ı 173	ç 189	= 205	ı 221	ÿ 237	² 253
E	Ä 142	Ş 158	« 174	¥ 190	 206	İ 222	– 238	■ 254
F	Å 143	ş 159	» 175	‡ 191	α 207	■ 223	’ 239	SP 255

Page 14 (PC737: Greek)

HEX	8	9	A	B	C	D	E	F
0	A 128	P 144	ι 160	 176	L 192	⊥ 208	ω 224	Ω 240
1	B 129	Σ 145	κ 161	 177	⊥ 193	⊥ 209	ά 225	± 241
2	Γ 130	Τ 146	λ 162	 178	Τ 194	Π 210	έ 226	≥ 242
3	Δ 131	Υ 147	μ 163	 179	⊥ 195	⊥ 211	ή 227	≤ 243
4	E 132	Φ 148	ν 164	⊥ 180	— 196	⊥ 212	ι 228	ï 244
5	Z 133	X 149	ξ 165	⊥ 181	⊥ 197	F 213	ι 229	ÿ 245
6	H 134	Ψ 150	ο 166	⊥ 182	⊥ 198	Π 214	ό 230	÷ 246
7	Θ 135	Ω 151	π 167	Π 183	⊥ 199	⊥ 215	ύ 231	≈ 247
8	I 136	α 152	ρ 168	⊥ 184	⊥ 200	⊥ 216	ü 232	° 248
9	K 137	β 153	σ 169	⊥ 185	⊥ 201	⊥ 217	ώ 233	• 249
A	Λ 138	γ 154	ς 170	⊥ 186	⊥ 202	⊥ 218	Α 234	· 250
B	M 139	δ 155	τ 171	⊥ 187	⊥ 203	 219	Έ 235	√ 251
C	N 140	ε 156	υ 172	⊥ 188	⊥ 204	 220	Ή 236	ⁿ 252
D	≡ 141	ζ 157	φ 173	⊥ 189	= 205	⊥ 221	Ί 237	² 253
E	O 142	η 158	χ 174	⊥ 190	⊥ 206	⊥ 222	Ό 238	■ 254
F	Π 143	θ 159	ψ 175	⊥ 191	⊥ 207	 223	Ύ 239	SP 255

HEX	8	9	A	B	C	D	E	F
0	SP 128	SP 144	SP 160	° 176	ï 192	Π 208	Û 224	π 240
1	SP 129	SP 145	‘ 161	± 177	Α 193	Ρ 209	α 225	ρ 241
2	SP 130	SP 146	’ 162	² 178	Β 194	Σ 210	β 226	ς 242
3	SP 131	SP 147	£ 163	³ 179	Γ 195	Σ 211	γ 227	σ 243
4	SP 132	SP 148	€ 164	´ 180	Δ 196	Τ 212	δ 228	τ 244
5	SP 133	SP 149	Ɔ 165	ˆ 181	Ε 197	Υ 213	ε 229	υ 245
6	SP 134	SP 150	ı 166	Α 182	Ζ 198	Φ 214	ζ 230	φ 246
7	SP 135	SP 151	§ 167	• 183	Η 199	Χ 215	η 231	χ 247
8	SP 136	SP 152	¨ 168	Έ 184	Θ 200	Ψ 216	θ 232	ψ 248
9	SP 137	SP 153	© 169	Ή 185	Ι 201	Ω 217	ι 233	ω 249
A	SP 138	SP 154	˘ 170	Ί 186	Κ 202	Ϊ 218	κ 234	ϊ 250
B	SP 139	SP 155	« 171	» 187	Λ 203	ÿ 219	λ 235	ÿ 251
C	SP 140	SP 156	¬ 172	Ό 188	Μ 204	ά 220	μ 236	ό 252
D	SP 141	SP 157	- 173	½ 189	Ν 205	έ 221	ν 237	ύ 253
E	SP 142	SP 158	SP 174	Υ 190	Ξ 206	ή 222	ξ 238	ώ 254
F	SP 143	SP 159	— 175	Ω 191	Ο 207	ι 223	ο 239	SP 255

HEX	8	9	A	B	C	D	E	F
0	€ 128	SP 144	SP 160	° 176	À 192	Đ 208	à 224	đ 240
1	SP 129	‘ 145	ı 161	± 177	Á 193	Ñ 209	á 225	ñ 241
2	, 130	’ 146	ç 162	² 178	Â 194	Ò 210	â 226	ò 242
3	f 131	“ 147	£ 163	³ 179	Ã 195	Ó 211	ã 227	ó 243
4	” 132	” 148	¤ 164	´ 180	Ä 196	Ô 212	ä 228	ô 244
5	... 133	• 149	¥ 165	µ 181	Å 197	Õ 213	å 229	õ 245
6	† 134	– 150	ı 166	¶ 182	Æ 198	Ö 214	æ 230	ö 246
7	‡ 135	— 151	§ 167	· 183	Ç 199	× 215	ç 231	÷ 247
8	^ 136	~ 152	¨ 168	¸ 184	È 200	Ø 216	è 232	ø 248
9	‰ 137	™ 153	© 169	¹ 185	É 201	Ù 217	é 233	ù 249
A	Š 138	š 154	ª 170	º 186	Ê 202	Ú 218	ê 234	ú 250
B	‹ 139	› 155	« 171	» 187	Ë 203	Û 219	ë 235	û 251
C	Œ 140	œ 156	¬ 172	¼ 188	Ì 204	Ü 220	ì 236	ü 252
D	SP 141	SP 157	- 173	½ 189	Í 205	Ý 221	í 237	ý 253
E	Ž 142	ž 158	® 174	¾ 190	Î 206	Þ 222	î 238	þ 254
F	SP 143	ÿ 159	– 175	¿ 191	Ï 207	ß 223	ï 239	ÿ 255

HEX	8	9	A	B	C	D	E	F
0	А 128	Р 144	а 160	▒ 176	Л 192	л 208	р 224	ё 240
1	Б 129	С 145	б 161	▓ 177	л 193	т 209	с 225	ё 241
2	В 130	Т 146	в 162	█ 178	т 194	п 210	т 226	ё 242
3	Г 131	У 147	г 163	 179	т 195	л 211	у 227	ё 243
4	Д 132	Ф 148	д 164	┆ 180	— 196	л 212	ф 228	ï 244
5	Е 133	Х 149	е 165	┆ 181	† 197	т 213	х 229	ï 245
6	Ж 134	Ц 150	ж 166	 182	т 198	т 214	ц 230	ÿ 246
7	З 135	Ч 151	з 167	т 183	 199	т 215	ч 231	ÿ 247
8	И 136	Ш 152	и 168	т 184	л 200	т 216	ш 232	° 248
9	Й 137	Щ 153	й 169	 185	т 201	т 217	щ 233	• 249
A	К 138	Ъ 154	к 170	 186	л 202	т 218	ъ 234	· 250
B	Л 139	Ы 155	л 171	т 187	т 203	█ 219	ы 235	√ 251
C	М 140	Ь 156	м 172	л 188	т 204	█ 220	ь 236	№ 252
D	Н 141	Э 157	н 173	л 189	= 205	█ 221	э 237	¤ 253
E	О 142	Ю 158	о 174	т 190	т 206	█ 222	ю 238	■ 254
F	П 143	Я 159	п 175	т 191	л 207	█ 223	я 239	SP 255

Page 18 (PC852: Latin2)

HEX	8	9	A	B	C	D	E	F
0	Ç 128	É 144	á 160	☐ 176	Ł 192	đ 208	Ó 224	- 240
1	ü 129	Í 145	í 161	☐ 177	⊥ 193	Đ 209	β 225	“ 241
2	é 130	Í 146	ó 162	☐ 178	⊥ 194	Ď 210	Ô 226	˘ 242
3	â 131	ô 147	ú 163	 179	† 195	Ě 211	Ń 227	˘ 243
4	ä 132	ö 148	Ą 164	† 180	- 196	ď 212	ń 228	˘ 244
5	û 133	Ĺ 149	ą 165	Á 181	† 197	Ň 213	ň 229	§ 245
6	ć 134	ĭ 150	ž 166	Â 182	Ǻ 198	Í 214	Š 230	÷ 246
7	ç 135	Ś 151	ż 167	Ě 183	ǻ 199	Î 215	š 231	˘ 247
8	ł 136	ś 152	Ę 168	Ş 184	Ł 200	ě 216	Ŕ 232	° 248
9	ë 137	Ö 153	ę 169	‡ 185	Ɔ 201	Ɔ 217	Ú 233	“ 249
A	Ő 138	Ü 154	SP 170	 186	⊥ 202	Ɔ 218	ŕ 234	• 250
B	ő 139	Ť 155	ž 171	‡ 187	⊥ 203	■ 219	Ů 235	ů 251
C	î 140	ĭ 156	Č 172	‡ 188	‡ 204	■ 220	ý 236	Ř 252
D	Ž 141	Ł 157	ş 173	Ž 189	= 205	‡ 221	Ý 237	ř 253
E	Ä 142	× 158	« 174	ž 190	‡ 206	Ů 222	‡ 238	■ 254
F	Ć 143	č 159	» 175	‡ 191	α 207	■ 223	’ 239	SP 255

HEX	8	9	A	B	C	D	E	F
0	Ç 128	É 144	á 160	☐ 176	Ł 192	ð 208	Ó 224	- 240
1	ü 129	æ 145	í 161	☐ 177	⊥ 193	Ð 209	β 225	± 241
2	é 130	Æ 146	ó 162	☐ 178	⊥ 194	Ê 210	Ô 226	= 242
3	â 131	ô 147	ú 163	 179	† 195	Ë 211	Ò 227	¾ 243
4	ä 132	ö 148	ñ 164	‡ 180	- 196	È 212	õ 228	¶ 244
5	à 133	ò 149	Ñ 165	Á 181	† 197	€ 213	Õ 229	§ 245
6	å 134	û 150	ä 166	Â 182	ã 198	Í 214	μ 230	÷ 246
7	ç 135	ù 151	å 167	À 183	Ã 199	Î 215	þ 231	˘ 247
8	ê 136	ÿ 152	ç 168	© 184	ℒ 200	Ï 216	ƒ 232	° 248
9	ë 137	Ö 153	® 169	‡ 185	℞ 201	Ɔ 217	Ú 233	¨ 249
A	è 138	Ü 154	¬ 170	 186	⊥ 202	ƒ 218	Û 234	· 250
B	ï 139	ø 155	½ 171	¶ 187	π 203	■ 219	Ù 235	¹ 251
C	î 140	£ 156	¼ 172	¶ 188	 204	■ 220	Ý 236	³ 252
D	ì 141	Ø 157	ì 173	¢ 189	= 205	ì 221	Ý 237	² 253
E	Ä 142	× 158	« 174	¥ 190	 206	Ï 222	- 238	■ 254
F	Å 143	f 159	» 175	‡ 191	α 207	■ 223	' 239	SP 255

HEX	8	9	A	B	C	D	E	F
0	┌ 128	○ 144	SP 160	ฅ 176	ย 192	เ 208	' 224	๒ 240
1	┐ 129	๑ 145	ก 161	ณ 177	ร 193	แ 209	๖ 225	๓ 241
2	└ 130	๒ 146	ข 162	ด 178	ฤ 194	โ 210	๗ 226	๔ 242
3	┘ 131	๓ 147	ค 163	ต 179	ล 195	ใ 211	๘ 227	๕ 243
4	┌ 132	๔ 148	ฆ 164	ถ 180	ว 196	ใ 212	๙ 228	๖ 244
5	┐ 133	๕ 149	ง 165	ท 181	ศ 197	ๆ 213	๑๐ 229	๗ 245
6	└ 134	๖ 150	จ 166	ธ 182	ษ 198	ๆ 214	๑๑ 230	๘ 246
7	┘ 135	๗ 151	ฉ 167	น 183	ส 199	' 215	๑๒ 231	๙ 247
8	┌ 136	๘ 152	ช 168	บ 184	ห 200	๒ 216	๑๓ 232	๑๐ 248
9	┐ 137	๙ 153	ซ 169	ป 185	ฬ 201	๓ 217	๑๔ 233	๑๑ 249
A	└ 138	๑๐ 154	ฅ 170	ผ 186	อ 202	๔ 218	๑๕ 234	๑๒ 250
B	█ 139	๑๑ 155	ญ 171	ฝ 187	ฮ 203	๕ 219	๑๖ 235	๑๓ 251
C	← 140	โ 156	ฎ 172	พ 188	๖ 204	๖ 220	๑๗ 236	๑๔ 252
D	↑ 141	ใ 157	ฏ 173	ฟ 189	ภ 205	๗ 221	๑๘ 237	๑๕ 253
E	→ 142	ใ 158	ฐ 174	ภ 190	า 206	๘ 222	๑๙ 238	๑๖ 254
F	↓ 143	เ 159	ท 175	ม 191	ำ 207	๙ 223	๒๐ 239	SP 255

HEX	8	9	A	B	C	D	E	F
0	๐ 128	๑ 144	๒ 160	๓ 176	๔ 192	๕ 208	๖ 224	๗ 240
1	๘ 129	๙ 145	๐ 161	๑ 177	๒ 193	๓ 209	๔ 225	๕ 241
2	๖ 130	๗ 146	๘ 162	๙ 178	๐ 194	๑ 210	๒ 226	๓ 242
3	๘ 131	๙ 147	๐ 163	๑ 179	๒ 195	๓ 211	๔ 227	๕ 243
4	๐ 132	๑ 148	๒ 164	๓ 180	๔ 196	๕ 212	๖ 228	๗ 244
5	๑ 133	๒ 149	๓ 165	๔ 181	๕ 197	๖ 213	๗ 229	๘ 245
6	๒ 134	๓ 150	๔ 166	๕ 182	๖ 198	๗ 214	๘ 230	๙ 246
7	๓ 135	๔ 151	๕ 167	๖ 183	๗ 199	๘ 215	๙ 231	๐ 247
8	๔ 136	๕ 152	๖ 168	๗ 184	๘ 200	๙ 216	๐ 232	๑ 248
9	๕ 137	๖ 153	๗ 169	๘ 185	๙ 201	๐ 217	๑ 233	๒ 249
A	๖ 138	๗ 154	๘ 170	๙ 186	๐ 202	๑ 218	๒ 234	๓ 250
B	๗ 139	๘ 155	๙ 171	๐ 187	๑ 203	๒ 219	๓ 235	๔ 251
C	๘ 140	๙ 156	๐ 172	๑ 188	๒ 204	๓ 220	๔ 236	๕ 252
D	๙ 141	๐ 157	๑ 173	๒ 189	๓ 205	๔ 221	๕ 237	๖ 253
E	๐ 142	๑ 158	๒ 174	๓ 190	๔ 206	๕ 222	๖ 238	๗ 254
F	๑ 143	๒ 159	๓ 175	๔ 191	๕ 207	๖ 223	๗ 239	๘ 255

Page 26 (TIS18: Thai)

HEX	8	9	A	B	C	D	E	F
0	┌ 128	┐ 144	SP 160	๒ 176	๓ 192	๔ 208	๕ 224	๖ 240
1	└ 129	┑ 145	ก 161	ข 177	ฃ 193	๔ 209	๕ 225	๖ 241
2	┌ 130	๔ 146	ข 162	ฃ 178	๔ 194	๕ 210	๖ 226	๗ 242
3	└ 131	๕ 147	ข 163	ฃ 179	๔ 195	๕ 211	๖ 227	๗ 243
4	┌ 132	๕ 148	ค 164	ด 180	๓ 196	๔ 212	๕ 228	๖ 244
5	└ 133	๕ 149	ค 165	ด 181	ล 197	๔ 213	๕ 229	๖ 245
6	┌ 134	๕ 150	ฃ 166	๓ 182	๓ 198	๔ 214	๕ 230	๖ 246
7	└ 135	๕ 151	ง 167	๓ 183	ว 199	๔ 215	๕ 231	๖ 247
8	┌ 136	๕ 152	จ 168	๓ 184	๓ 200	๔ 216	๕ 232	๖ 248
9	└ 137	๕ 153	ฉ 169	๓ 185	๓ 201	๔ 217	๕ 233	๖ 249
A	┌ 138	๕ 154	ช 170	๓ 186	๓ 202	๔ 218	๕ 234	๖ 250
B	█ 139	๕ 155	ช 171	๓ 187	๓ 203	๔ 219	๕ 235	๖ 251
C	← 140	๕ 156	ฃ 172	๓ 188	๓ 204	๔ 220	๕ 236	๖ 252
D	↑ 141	๕ 157	ฃ 173	๓ 189	๓ 205	๔ 221	๕ 237	๖ 253
E	→ 142	๕ 158	ฃ 174	๓ 190	๓ 206	๔ 222	๕ 238	๖ 254
F	↓ 143	๕ 159	ฃ 175	๓ 191	๓ 207	๔ 223	๕ 239	๖ 255

HEX	8	9	A	B	C	D	E	F
0	SP 128	SP 144	SP 160	SP 176	SP 192	é 208	SP 224	SP 240
1	SP 129	SP 145	SP 161	SP 177	SP 193	ẹ 209	ỏ 225	ủ 241
2	SP 130	SP 146	SP 162	SP 178	SP 194	ề 210	õ 226	ũ 242
3	SP 131	SP 147	SP 163	SP 179	SP 195	ễ 211	ó 227	ú 243
4	SP 132	SP 148	SP 164	SP 180	SP 196	ễ 212	ọ 228	ụ 244
5	SP 133	SP 149	SP 165	à 181	SP 197	ể 213	ồ 229	ừ 245
6	SP 134	SP 150	SP 166	ả 182	ă 198	ệ 214	ố 230	ừ 246
7	SP 135	SP 151	SP 167	ã 183	â 199	ì 215	ổ 231	ừ 247
8	SP 136	SP 152	ă 168	á 184	ã 200	ỉ 216	ổ 232	ừ 248
9	SP 137	SP 153	â 169	ạ 185	ã 201	SP 217	ộ 233	ự 249
A	SP 138	SP 154	ê 170	SP 186	ã 202	SP 218	ờ 234	ỳ 250
B	SP 139	SP 155	ô 171	ã 187	ậ 203	SP 219	ở 235	ỳ 251
C	SP 140	SP 156	ơ 172	ã 188	è 204	ĩ 220	ỡ 236	ỳ 252
D	SP 141	SP 157	ư 173	ã 189	SP 205	í 221	ớ 237	ỳ 253
E	SP 142	SP 158	đ 174	ã 190	ẻ 206	ị 222	ợ 238	ỵ 254
F	SP 143	SP 159	SP 175	SP 191	ễ 207	ò 223	ù 239	SP 255

Page 31 (TCVN-3: Vietnamese)

HEX	8	9	A	B	C	D	E	F
0	SP 128	SP 144	SP 160	SP 176	SP 192	É 208	SP 224	SP 240
1	SP 129	SP 145	Ă 161	SP 177	SP 193	Ě 209	Ỗ 225	Ủ 241
2	SP 130	SP 146	Â 162	SP 178	SP 194	Ê 210	Ỗ 226	Ủ 242
3	SP 131	SP 147	SP 163	SP 179	SP 195	Ë 211	Ó 227	Ú 243
4	SP 132	SP 148	SP 164	SP 180	SP 196	Ě 212	Ọ 228	Ụ 244
5	SP 133	SP 149	SP 165	À 181	SP 197	Ë 213	Ồ 229	Ừ 245
6	SP 134	SP 150	SP 166	Ả 182	Ạ 198	Ě 214	Ỗ 230	Ừ 246
7	SP 135	SP 151	Đ 167	Ă 183	Â 199	ì 215	Ỗ 231	Ừ 247
8	SP 136	SP 152	SP 168	Á 184	Ã 200	ĩ 216	Ỗ 232	Ừ 248
9	SP 137	SP 153	SP 169	Ạ 185	Ã 201	SP 217	Ỗ 233	Ừ 249
A	SP 138	SP 154	Ê 170	SP 186	Ã 202	SP 218	Ờ 234	Ỡ 250
B	SP 139	SP 155	Ô 171	Ă 187	Ạ 203	SP 219	Ỗ 235	Ỡ 251
C	SP 140	SP 156	Ơ 172	Ă 188	È 204	ĩ 220	Ỗ 236	Ỡ 252
D	SP 141	SP 157	Ừ 173	Ă 189	SP 205	í 221	Ớ 237	Ỡ 253
E	SP 142	SP 158	SP 174	Ả 190	È 206	! 222	Ỗ 238	Ỡ 254
F	SP 143	SP 159	SP 175	SP 191	Ë 207	Ò 223	Ừ 239	SP 255



HEX	8	9	A	B	C	D	E	F
0	SP 128	SP 144	ب 160	◻ 176	ل 192	ﻻ 208	ن 224	≡ 240
1	SP 129	◻ 145	ة 161	◻ 177	ﻻ 193	ﻻ 209	ط 225	◻ 241
2	é 130	◻ 146	ت 162	◻ 178	ﻻ 194	ﻻ 210	ظ 226	◻ 242
3	â 131	ô 147	ث 163	 179	ﻻ 195	ﻻ 211	ع 227	◻ 243
4	SP 132	◻ 148	ج 164	ﻻ 180	- 196	ﻻ 212	غ 228	◻ 244
5	à 133	- 149	ح 165	ﻻ 181	ﻻ 197	ﻻ 213	ف 229	◻ 245
6	SP 134	û 150	خ 166	ﻻ 182	ﻻ 198	ﻻ 214	م 230	◻ 246
7	ç 135	ù 151	د 167	ﻻ 183	ﻻ 199	ﻻ 215	ق 231	◻ 247
8	ê 136	ء 152	ذ 168	ﻻ 184	ﻻ 200	ﻻ 216	ك 232	◻ 248
9	ë 137	أ 153	ر 169	ﻻ 185	ﻻ 201	ﻻ 217	ل 233	◻ 249
A	è 138	أ 154	ز 170	ﻻ 186	ﻻ 202	ﻻ 218	م 234	◻ 250
B	ï 139	ؤ 155	س 171	ﻻ 187	ﻻ 203	◻ 219	ن 235	√ 251
C	î 140	£ 156	ش 172	ﻻ 188	ﻻ 204	◻ 220	ه 236	n 252
D	SP 141	إ 157	ي 173	ﻻ 189	= 205	◻ 221	و 237	z 253
E	SP 142	ى 158	« 174	ﻻ 190	ﻻ 206	◻ 222	ى 238	◻ 254
F	SP 143	ا 159	» 175	ﻻ 191	ﻻ 207	◻ 223	ي 239	SP 255

Page 33 (WPC775: Baltic Rim)

HEX	8	9	A	B	C	D	E	F
0	Ć 128	É 144	Ā 160	☐ 176	Ł 192	ą 208	Ó 224	- 240
1	ü 129	æ 145	Ī 161	☐ 177	Ł 193	č 209	ß 225	± 241
2	é 130	Æ 146	ó 162	☐ 178	Ṭ 194	ę 210	Ō 226	“ 242
3	ā 131	ō 147	Ž 163	 179	† 195	è 211	Ń 227	¾ 243
4	ä 132	ö 148	ž 164	† 180	- 196	ì 212	õ 228	¶ 244
5	ǵ 133	Ǵ 149	ž 165	Ą 181	† 197	š 213	Ŏ 229	§ 245
6	â 134	ç 150	” 166	Č 182	Ų 198	ų 214	μ 230	÷ 246
7	ć 135	Ś 151	 167	Ę 183	Ū 199	ū 215	ń 231	” 247
8	ł 136	ś 152	© 168	É 184	Ł 200	ž 216	Ų 232	° 248
9	ē 137	Ö 153	® 169	‡ 185	Ŧ 201	Ɔ 217	ķ 233	· 249
A	Ŕ 138	Ü 154	¬ 170	 186	Ł 202	Ŧ 218	Ł 234	· 250
B	ŗ 139	ø 155	½ 171	¶ 187	Ṭ 203	■ 219	↓ 235	¹ 251
C	ī 140	£ 156	¼ 172	¶ 188	¶ 204	■ 220	ŋ 236	³ 252
D	Ž 141	Ø 157	Ł 173	ł 189	= 205	■ 221	Ě 237	² 253
E	Ä 142	× 158	« 174	Š 190	¶ 206	■ 222	Ņ 238	■ 254
F	Å 143	α 159	» 175	Ɔ 191	Ž 207	■ 223	' 239	SP 255

HEX	8	9	A	B	C	D	E	F
0	ђ 128	љ 144	а 160	▒ 176	Љ 192	л 208	Я 224	- 240
1	Ђ 129	Љ 145	А 161	▒ 177	Љ 193	Л 209	Р 225	Ы 241
2	ѓ 130	њ 146	б 162	▒ 178	Т 194	М 210	Р 226	Ы 242
3	Ѓ 131	Њ 147	Б 163	 179	Ѡ 195	М 211	С 227	З 243
4	ё 132	ђ 148	ц 164	† 180	— 196	Н 212	С 228	З 244
5	Ё 133	Ђ 149	Ц 165	х 181	† 197	Н 213	Т 229	Ш 245
6	е 134	ќ 150	д 166	Х 182	К 198	О 214	Т 230	Ш 246
7	Е 135	Ќ 151	Д 167	и 183	К 199	О 215	У 231	Э 247
8	ѕ 136	ђ 152	е 168	И 184	Љ 200	П 216	У 232	Э 248
9	Ѕ 137	Ђ 153	Е 169	Ѣ 185	Г 201	Ј 217	Ж 233	Щ 249
A	і 138	ѣ 154	ф 170	 186	Љ 202	Г 218	Ж 234	Щ 250
B	І 139	ѣ 155	Ф 171	Ѡ 187	Ѡ 203	■ 219	В 235	Ч 251
C	ї 140	ю 156	Г 172	Ѣ 188	Ѣ 204	■ 220	В 236	Ч 252
D	Ї 141	Ю 157	Г 173	й 189	= 205	П 221	Ь 237	§ 253
E	ј 142	ѣ 158	« 174	Й 190	Ѣ 206	Я 222	Ь 238	■ 254
F	Ј 143	ѣ 159	» 175	Г 191	Ѡ 207	■ 223	№ 239	SP 255

Page 35 (PC861: Icelandic)

HEX	8	9	A	B	C	D	E	F
0	Ç 128	É 144	á 160	 176	L 192	⌌ 208	α 224	≡ 240
1	ü 129	æ 145	í 161	 177	⊥ 193	⸮ 209	ß 225	± 241
2	é 130	Æ 146	ó 162	 178	⸮ 194	⸮ 210	Γ 226	≥ 242
3	â 131	ô 147	ú 163	 179	⸮ 195	⌌ 211	π 227	≤ 243
4	ä 132	ö 148	Á 164	⸮ 180	— 196	⸮ 212	Σ 228	∫ 244
5	à 133	þ 149	í 165	⸮ 181	† 197	F 213	σ 229	∫ 245
6	å 134	û 150	Ó 166	⸮ 182	ƒ 198	π 214	μ 230	÷ 246
7	ç 135	Ý 151	Ú 167	⸮ 183	⸮ 199	⸮ 215	τ 231	≈ 247
8	ê 136	ý 152	ı 168	⸮ 184	⌌ 200	⸮ 216	Φ 232	° 248
9	ë 137	Ö 153	ƒ 169	⸮ 185	ƒ 201	⸮ 217	Θ 233	· 249
A	è 138	Ü 154	ƒ 170	⸮ 186	⸮ 202	ƒ 218	Ω 234	· 250
B	Ð 139	ø 155	½ 171	⸮ 187	⸮ 203	■ 219	ð 235	√ 251
C	ð 140	£ 156	¼ 172	⸮ 188	⸮ 204	■ 220	∞ 236	ⁿ 252
D	þ 141	Ø 157	i 173	⸮ 189	= 205	■ 221	φ 237	² 253
E	Ä 142	Pt 158	« 174	⸮ 190	⸮ 206	■ 222	ε 238	■ 254
F	Å 143	f 159	» 175	⸮ 191	⸮ 207	■ 223	∩ 239	SP 255

HEX	8	9	A	B	C	D	E	F
0	כ 128	ג 144	á 160	☐ 176	ל 192	⌌ 208	α 224	≡ 240
1	כּ 129	גּ 145	í 161	☐̇ 177	⌒ 193	⌒̇ 209	β 225	± 241
2	כׁ 130	גׁ 146	ó 162	☐̈ 178	⌒̈ 194	⌒̈̇ 210	Γ 226	≥ 242
3	כ׃ 131	ג׃ 147	ú 163	179	⌒̈̇ 195	⌌̇ 211	π 227	≤ 243
4	כׄ 132	גׄ 148	ñ 164	⌒̈̇ 180	— 196	⌌̈ 212	Σ 228	∫ 244
5	כׅ 133	גׅ 149	Ñ 165	⌒̈̇̇ 181	⌒̈̇̇ 197	⌌̈̇ 213	σ 229	∫̇ 245
6	כ׆ 134	ג׆ 150	ª 166	⌒̈̇̇̇ 182	⌒̈̇̇̇ 198	⌌̈̇̇ 214	μ 230	÷ 246
7	כׇ 135	גׇ 151	º 167	⌒̈̇̇̇̇ 183	⌒̈̇̇̇̇ 199	⌌̈̇̇̇ 215	τ 231	≈ 247
8	כ׈ 136	ג׈ 152	¿ 168	⌒̈̇̇̇̇̇ 184	⌌̈̇̇̇̇ 200	⌌̈̇̇̇̇̇ 216	Φ 232	° 248
9	כ׉ 137	ג׉ 153	ƒ 169	⌒̈̇̇̇̇̇̇ 185	⌒̈̇̇̇̇̇̇ 201	⌌̈̇̇̇̇̇̇ 217	Θ 233	· 249
A	כ׊ 138	ג׊ 154	ƒ̇ 170	⌒̈̇̇̇̇̇̇̇ 186	⌌̈̇̇̇̇̇̇̇ 202	⌒̈̇̇̇̇̇̇̇ 218	Ω 234	·̇ 250
B	כ׋ 139	¢ 155	½ 171	⌒̈̇̇̇̇̇̇̇̇ 187	⌒̈̇̇̇̇̇̇̇̇ 203	■ 219	δ 235	√ 251
C	כ׌ 140	£ 156	¼ 172	⌒̈̇̇̇̇̇̇̇̇̇ 188	⌒̈̇̇̇̇̇̇̇̇̇ 204	■̇ 220	∞ 236	ⁿ 252
D	כ׍ 141	¥ 157	ı 173	⌒̈̇̇̇̇̇̇̇̇̇̇ 189	= 205	■̈ 221	φ 237	² 253
E	כ׎ 142	Pt 158	« 174	⌒̈̇̇̇̇̇̇̇̇̇̇̇ 190	⌒̈̇̇̇̇̇̇̇̇̇̇̇ 206	■̈̇ 222	ε 238	■̈̈ 254
F	כ׏ 143	f 159	» 175	⌒̈̇̇̇̇̇̇̇̇̇̇̇̇ 191	⌒̈̇̇̇̇̇̇̇̇̇̇̇̇̇ 207	■̈̇̇ 223	∩ 239	SP 255

Page 37 (PC864: Arabic)

HEX	8	9	A	B	C	D	E	F
0	° 128	β 144	SP 160	◌ 176	ϕ 192	ذ 208	- 224	? 240
1	◌ 129	∞ 145	 161	◌ 177	ء 193	ر 209	ف 225	? 241
2	◌ 130	φ 146	آ 162	٢ 178	آ 194	ز 210	ق 226	ن 242
3	√ 131	± 147	£ 163	٣ 179	أ 195	ء 211	ك 227	ه 243
4	 132	½ 148	¤ 164	٤ 180	ؤ 196	ث 212	ل 228	ه 244
5	— 133	¼ 149	أ 165	ه 181	ع 197	ط 213	م 229	ي 245
6	 134	≈ 150	SP 166	٦ 182	ذ 198	ظ 214	ذ 230	ي 246
7	† 135	« 151	€ 167	٧ 183	ا 199	ط 215	ه 231	غ 247
8	‡ 136	» 152	ا 168	٨ 184	ب 200	ظ 216	و 232	ق 248
9	⊤ 137	لا 153	ب 169	٩ 185	ة 201	ء 217	ي 233	لا 249
A	⊥ 138	لا 154	ت 170	ف 186	ت 202	غ 218	ي 234	لا 250
B	⊥ 139	SP 155	ث 171	؛ 187	ث 203	ا 219	ض 235	ل 251
C	⊥ 140	SP 156	، 172	س 188	ج 204	ا 220	ع 236	ك 252
D	⊥ 141	لا 157	ج 173	ش 189	ح 205	÷ 221	غ 237	ي 253
E	⊥ 142	لا 158	ح 174	ص 190	خ 206	× 222	غ 238	■ 254
F	⊥ 143	ء 159	خ 175	? 191	د 207	ع 223	م 239	SP 255

HEX	8	9	A	B	C	D	E	F
0	SP 128	Ì 144	ï 160	⋯ 176	Ł 192	Ŧ 208	ζ 224	240
1	SP 129	Ï 145	ï̇ 161	⋮ 177	⊥ 193	Υ 209	η 225	± 241
2	SP 130	Ŏ 146	ó 162	⋭ 178	Ŧ 194	Φ 210	θ 226	υ 242
3	SP 131	SP 147	ú 163	 179	† 195	Χ 211	ι 227	φ 243
4	SP 132	SP 148	À 164	‡ 180	— 196	Ψ 212	κ 228	χ 244
5	SP 133	Ÿ 149	Β 165	Κ 181	‡ 197	Ω 213	λ 229	§ 245
6	À 134	ÿ 150	Γ 166	Λ 182	Π 198	α 214	μ 230	ψ 246
7	€ 135	© 151	Δ 167	Μ 183	Ρ 199	β 215	ν 231	™ 247
8	· 136	Ω 152	Ε 168	Ν 184	ℒ 200	γ 216	ξ 232	° 248
9	¬ 137	² 153	Ζ 169	‡ 185	℞ 201	Ɔ 217	ο 233	™ 249
A	¡ 138	³ 154	Η 170	 186	℥ 202	Γ 218	π 234	ω 250
B	‘ 139	ά 155	½ 171	‡ 187	π̄ 203	■ 219	ρ 235	ü 251
C	’ 140	£ 156	Θ 172	‡ 188	℥ 204	■ 220	σ 236	ÿ 252
D	Έ 141	έ 157	Ι 173	≡ 189	= 205	δ 221	ς 237	ώ 253
E	— 142	ή 158	« 174	Ο 190	‡ 206	ε 222	τ 238	■ 254
F	Ή 143	ì 159	» 175	γ 191	Σ 207	■ 223	’ 239	SP 255

Page 39 (ISO8859-2: Latin2)

HEX	8	9	A	B	C	D	E	F
0	☐ 128	Ł 144	SP 160	° 176	Ř 192	Đ 208	ř 224	ď 240
1	☐ 129	ł 145	Ą 161	ą 177	Á 193	Ń 209	á 225	ń 241
2	☐ 130	Ṭ 146	˘ 162	˙ 178	Â 194	Ň 210	â 226	ň 242
3	 131	Ṯ 147	Ł 163	ł 179	Ă 195	Ó 211	ă 227	ó 243
4	┆ 132	— 148	ą 164	’ 180	Ä 196	Ô 212	ä 228	ô 244
5	Ј 133	† 149	Ĺ 165	ĳ 181	Í 197	Ť 213	í 229	ĳ 245
6	Г 134	■ 150	Ś 166	ś 182	Ć 198	Ö 214	ć 230	ö 246
7	■ 135	■ 151	Ş 167	˘ 183	Ç 199	× 215	ş 231	÷ 247
8	© 136	Ł 152	“ 168	’ 184	Č 200	Ř 216	č 232	ř 248
9	Ꞥ 137	Ꞥ 153	Š 169	š 185	É 201	Û 217	é 233	û 249
A	Ꞥ 138	Ꞥ 154	Ş 170	ş 186	Ę 202	Ú 218	ę 234	ú 250
B	Ꞥ 139	Ꞥ 155	Ť 171	ť 187	Ě 203	Ů 219	ě 235	ů 251
C	Ꞥ 140	Ꞥ 156	Ž 172	ž 188	Ě 204	Ü 220	ě 236	ü 252
D	¢ 141	= 157	“ 173	” 189	Í 205	Ý 221	í 237	ý 253
E	¥ 142	Ꞥ 158	Ž 174	ž 190	Î 206	Ț 222	î 238	ț 254
F	ƒ 143	® 159	Ž 175	ž 191	Ď 207	ß 223	ď 239	· 255









HEX	8	9	A	B	C	D	E	F
0	SP 128	SP 144	SP 160	° 176	À 192	Ð 208	à 224	ð 240
1	SP 129	SP 145	¡ 161	± 177	Á 193	Ñ 209	á 225	ñ 241
2	SP 130	SP 146	¢ 162	² 178	Â 194	Ò 210	â 226	ò 242
3	SP 131	SP 147	£ 163	³ 179	Ã 195	Ó 211	ã 227	ó 243
4	SP 132	SP 148	€ 164	Ž 180	Ä 196	Ô 212	ä 228	ô 244
5	SP 133	SP 149	¥ 165	µ 181	Å 197	Õ 213	å 229	õ 245
6	SP 134	SP 150	Š 166	¶ 182	Æ 198	Ö 214	æ 230	ö 246
7	SP 135	SP 151	§ 167	· 183	Ç 199	× 215	ç 231	÷ 247
8	SP 136	SP 152	š 168	ž 184	È 200	Ø 216	è 232	ø 248
9	SP 137	SP 153	© 169	¹ 185	É 201	Ù 217	é 233	ù 249
A	SP 138	SP 154	ª 170	º 186	Ê 202	Ú 218	ê 234	ú 250
B	SP 139	SP 155	« 171	» 187	Ë 203	Û 219	ë 235	û 251
C	SP 140	SP 156	¬ 172	Œ 188	Ì 204	Ü 220	ì 236	ü 252
D	SP 141	SP 157	173	œ 189	Í 205	Ý 221	í 237	ý 253
E	SP 142	SP 158	® 174	ÿ 190	Î 206	Þ 222	î 238	þ 254
F	SP 143	SP 159	175	ı 191	Ï 207	ß 223	ï 239	ÿ 255

HEX	8	9	A	B	C	D	E	F
0	SP 128	و 144	ح 160	◻ 176	ل 192	ع 208	ک 224	240
1	SP 129	ئ 145	خ 161	◻ 177	ل 193	ء 209	ک 225	ی 241
2	، 130	ب 146	ذ 162	◻ 178	ت 194	ع 210	گ 226	پ 242
3	؛ 131	ب 147	د 163	 179	ت 195	غ 211	گ 227	- 243
4	؟ 132	پ 148	ذ 164	ت 180	- 196	غ 212	ل 228	۰ 244
5	ء 133	پ 149	ر 165	ض 181	ت 197	غ 213	ل 229	۱ 245
6	آ 134	ت 150	ز 166	ض 182	ظ 198	غ 214	م 230	۲ 246
7	آ 135	ت 151	ژ 167	ط 183	ع 199	ف 215	م 231	۳ 247
8	آ 136	ت 152	س 168	ط 184	ط 200	ف 216	ن 232	۴ 248
9	ا 137	ت 153	ء 169	ط 185	ط 201	ل 217	ن 233	۵ 249
A	ا 138	ج 154	ش 170	ط 186	ط 202	ط 218	و 234	۶ 250
B	ا 139	چ 155	ش 171	ط 187	ط 203	ط 219	ه 235	۷ 251
C	ء 140	چ 156	ص 172	ط 188	ط 204	ط 220	ه 236	۸ 252
D	أ 141	چ 157	ط 173	ط 189	= 205	ق 221	ه 237	۹ 253
E	أ 142	× 158	« 174	ظ 190	ط 206	ق 222	ه 238	■ 254
F	آ 143	ح 159	» 175	ط 191	SP 207	■ 223	ی 239	SP 255

HEX	8	9	A	B	C	D	E	F
0	Ç 128	É 144	á 160	☐ 176	Ł 192	ą 208	α 224	≡ 240
1	ü 129	æ 145	í 161	☐ 177	⊥ 193	č 209	β 225	± 241
2	é 130	Æ 146	ó 162	☐ 178	⊤ 194	ę 210	Γ 226	≥ 242
3	â 131	ô 147	ú 163	 179	† 195	è 211	π 227	≤ 243
4	ä 132	ö 148	ñ 164	‡ 180	– 196	ì 212	Σ 228	” 244
5	à 133	ò 149	Ñ 165	Ą 181	‡ 197	š 213	σ 229	“ 245
6	å 134	û 150	ª 166	Č 182	Ų 198	ų 214	μ 230	÷ 246
7	ç 135	ù 151	º 167	Ę 183	Ū 199	ū 215	τ 231	≈ 247
8	ê 136	ÿ 152	¿ 168	É 184	Ł 200	ž 216	Φ 232	° 248
9	ë 137	Ö 153	ƒ 169	‡ 185	Ɔ 201	Ɔ 217	Θ 233	· 249
A	è 138	Ü 154	ƒ 170	‡ 186	Ł 202	Ɔ 218	Ω 234	· 250
B	ï 139	ç 155	½ 171	‡ 187	π 203	■ 219	ð 235	√ 251
C	î 140	£ 156	¼ 172	‡ 188	Ɔ 204	■ 220	∞ 236	ⁿ 252
D	ì 141	¥ 157	ı 173	ł 189	= 205	■ 221	φ 237	² 253
E	Ä 142	Ɔ 158	« 174	Š 190	‡ 206	■ 222	ε 238	■ 254
F	Å 143	f 159	» 175	Ų 191	Ž 207	■ 223	∩ 239	SP 255

Page 43 (PC1119: Lithuanian)

HEX	8	9	A	B	C	D	E	F
0	А 128	Р 144	а 160	☐ 176	Л 192	ą 208	р 224	Ė 240
1	Б 129	С 145	б 161	☐ 177	⊥ 193	č 209	с 225	ė 241
2	В 130	Т 146	в 162	☐ 178	Т 194	ę 210	т 226	≥ 242
3	Г 131	У 147	г 163	 179	┆ 195	ė 211	у 227	≤ 243
4	Д 132	Ф 148	д 164	┆ 180	— 196	į 212	ф 228	” 244
5	Е 133	Х 149	е 165	Ą 181	† 197	š 213	х 229	“ 245
6	Ж 134	Ц 150	ж 166	Č 182	У 198	ų 214	ц 230	÷ 246
7	З 135	Ч 151	з 167	Ę 183	Ū 199	ū 215	ч 231	≈ 247
8	И 136	Ш 152	и 168	Ė 184	Ł 200	ž 216	ш 232	° 248
9	Й 137	Щ 153	й 169	‡ 185	Г 201	Ј 217	щ 233	· 249
A	К 138	Ъ 154	к 170	 186	⊥ 202	Г 218	ъ 234	· 250
B	Л 139	Ы 155	л 171	‡ 187	⊥ 203	■ 219	ы 235	√ 251
C	М 140	Ь 156	м 172	‡ 188	‡ 204	■ 220	ь 236	ⁿ 252
D	Н 141	Э 157	н 173	┆ 189	= 205	■ 221	э 237	² 253
E	О 142	Ю 158	о 174	Š 190	‡ 206	■ 222	ю 238	■ 254
F	П 143	Я 159	п 175	┆ 191	Ž 207	■ 223	я 239	SP 255

HEX	8	9	A	B	C	D	E	F
0	А 128	Р 144	а 160	 176	Л 192	л 208	р 224	Є 240
1	Б 129	С 145	б 161	 177	Л 193	л 209	с 225	ё 241
2	В 130	Т 146	в 162	 178	Т 194	т 210	т 226	ґ 242
3	Г 131	У 147	г 163	 179	т 195	л 211	у 227	ґ 243
4	Д 132	Ф 148	д 164	† 180	— 196	л 212	ф 228	Є 244
5	Е 133	Х 149	е 165	† 181	† 197	Г 213	х 229	є 245
6	Ж 134	Ц 150	ж 166	 182	† 198	Г 214	ц 230	і 246
7	З 135	Ч 151	з 167	 183	 199	 215	ч 231	і 247
8	И 136	Ш 152	и 168	† 184	л 200	† 216	ш 232	ї 248
9	Й 137	Щ 153	й 169	 185	Г 201	┘ 217	щ 233	ї 249
A	К 138	Ъ 154	к 170	 186	л 202	Г 218	ъ 234	÷ 250
B	Л 139	Ы 155	л 171	 187	л 203	 219	ы 235	± 251
C	М 140	Ь 156	м 172	л 188	л 204	 220	ь 236	№ 252
D	Н 141	Э 157	н 173	л 189	= 205	 221	э 237	¤ 253
E	О 142	Ю 158	о 174	л 190	 206	 222	ю 238	■ 254
F	П 143	Я 159	п 175	┘ 191	л 207	 223	я 239	SP 255

Page 45 (WPC1250: Latin 2)

HEX	8	9	A	B	C	D	E	F
0	€ 128	SP 144	SP 160	° 176	Ř 192	Đ 208	ř 224	ď 240
1	SP 129	‘ 145	˘ 161	± 177	Á 193	Ń 209	á 225	ń 241
2	, 130	, 146	˘ 162	˘ 178	Â 194	Ň 210	â 226	ň 242
3	SP 131	“ 147	Ł 163	ł 179	Ă 195	Ó 211	ă 227	ó 243
4	” 132	” 148	α 164	’ 180	Ä 196	Ô 212	ä 228	ô 244
5	... 133	• 149	Ą 165	μ 181	Ć 197	Ŏ 213	í 229	õ 245
6	† 134	— 150	ı 166	¶ 182	Ć 198	Ö 214	ć 230	ö 246
7	‡ 135	— 151	§ 167	· 183	Ç 199	× 215	ç 231	÷ 247
8	SP 136	SP 152	” 168	’ 184	Č 200	Ř 216	č 232	ř 248
9	‰ 137	™ 153	© 169	ą 185	É 201	Û 217	é 233	û 249
A	Š 138	š 154	Ş 170	ş 186	Ę 202	Ú 218	ę 234	ú 250
B	‹ 139	› 155	« 171	» 187	Ě 203	Ů 219	ě 235	ů 251
C	Ś 140	ś 156	¬ 172	Ĺ 188	Ě 204	Ü 220	ś 236	ü 252
D	Ť 141	ť 157	” 173	” 189	Í 205	Ý 221	í 237	ý 253
E	Ž 142	ž 158	® 174	Ÿ 190	Î 206	Ț 222	î 238	ț 254
F	Ż 143	ż 159	Ž 175	ż 191	Đ 207	ß 223	đ 239	· 255

HEX	8	9	A	B	C	D	E	F
0	Ђ 128	ђ 144	SP 160	° 176	А 192	Р 208	а 224	р 240
1	Ѓ 129	‘ 145	Ў 161	± 177	Б 193	С 209	б 225	с 241
2	, 130	, 146	ў 162	l 178	В 194	Т 210	в 226	т 242
3	ѓ 131	“ 147	Ј 163	і 179	Г 195	У 211	г 227	у 243
4	” 132	” 148	ѡ 164	ѓ 180	Д 196	Ф 212	д 228	ф 244
5	... 133	• 149	Ѓ 165	μ 181	Е 197	Х 213	е 229	х 245
6	† 134	— 150	Ѓ 166	¶ 182	Ж 198	Ц 214	ж 230	ц 246
7	‡ 135	— 151	§ 167	· 183	З 199	Ч 215	з 231	ч 247
8	€ 136	SP 152	Ё 168	ё 184	И 200	Ш 216	и 232	ш 248
9	‰ 137	™ 153	© 169	№ 185	Й 201	Щ 217	й 233	щ 249
A	Љ 138	љ 154	Є 170	є 186	К 202	Ъ 218	к 234	ъ 250
B	‹ 139	› 155	« 171	» 187	Л 203	Ы 219	л 235	ы 251
C	Њ 140	њ 156	¬ 172	ј 188	М 204	Ь 220	м 236	ь 252
D	Ќ 141	ќ 157	 173	ѕ 189	Н 205	Э 221	н 237	э 253
E	Ћ 142	ћ 158	® 174	ѕ 190	О 206	Ю 222	о 238	ю 254
F	Ѡ 143	ѡ 159	Ї 175	ї 191	П 207	Я 223	п 239	я 255

Page 47 (WPC1253: Greek)

HEX	8	9	A	B	C	D	E	F
0	€ 128	SP 144	SP 160	° 176	ï 192	Π 208	Û 224	π 240
1	SP 129	‘ 145	” 161	± 177	Α 193	Ρ 209	α 225	ρ 241
2	, 130	’ 146	À 162	² 178	Β 194	SP 210	β 226	ς 242
3	<i>f</i> 131	“ 147	£ 163	³ 179	Γ 195	Σ 211	γ 227	σ 243
4	” 132	” 148	α 164	’ 180	Δ 196	Τ 212	δ 228	τ 244
5	... 133	• 149	¥ 165	μ 181	Ε 197	Υ 213	ε 229	υ 245
6	† 134	— 150	¡ 166	¶ 182	Ζ 198	Φ 214	ζ 230	φ 246
7	‡ 135	— 151	§ 167	· 183	Η 199	Χ 215	η 231	χ 247
8	SP 136	SP 152	” 168	Έ 184	Θ 200	Ψ 216	θ 232	ψ 248
9	‰ 137	™ 153	© 169	Ή 185	Ι 201	Ω 217	ι 233	ω 249
A	SP 138	SP 154	ª 170	Ί 186	Κ 202	Ϊ 218	κ 234	ϊ 250
B	‹ 139	› 155	« 171	» 187	Λ 203	ÿ 219	λ 235	ÿ 251
C	SP 140	SP 156	¬ 172	Ό 188	Μ 204	ά 220	μ 236	ό 252
D	SP 141	SP 157	173	½ 189	Ν 205	έ 221	ν 237	ύ 253
E	SP 142	SP 158	® 174	Ύ 190	Ξ 206	ή 222	ξ 238	ώ 254
F	SP 143	SP 159	— 175	Ω 191	Ο 207	ι 223	ο 239	SP 255

HEX	8	9	A	B	C	D	E	F
0	€ 128	SP 144	SP 160	° 176	À 192	Ğ 208	à 224	ğ 240
1	SP 129	‘ 145	ı 161	± 177	Á 193	Ñ 209	á 225	ñ 241
2	, 130	’ 146	ç 162	² 178	Â 194	Ò 210	â 226	ò 242
3	f 131	“ 147	£ 163	³ 179	Ã 195	Ó 211	ã 227	ó 243
4	” 132	” 148	¤ 164	´ 180	Ä 196	Ô 212	ä 228	ô 244
5	... 133	• 149	¥ 165	µ 181	Å 197	Õ 213	å 229	õ 245
6	† 134	– 150	ı 166	¶ 182	Æ 198	Ö 214	æ 230	ö 246
7	‡ 135	— 151	§ 167	· 183	Ç 199	× 215	ç 231	÷ 247
8	^ 136	~ 152	¨ 168	¸ 184	È 200	Ø 216	è 232	ø 248
9	‰ 137	™ 153	© 169	¹ 185	É 201	Ù 217	é 233	ù 249
A	Š 138	š 154	ª 170	º 186	Ê 202	Ú 218	ê 234	ú 250
B	‹ 139	› 155	« 171	» 187	Ë 203	Û 219	ë 235	û 251
C	Œ 140	œ 156	¬ 172	¼ 188	Ì 204	Ü 220	ì 236	ü 252
D	SP 141	SP 157	173	½ 189	Í 205	İ 221	í 237	ı 253
E	SP 142	SP 158	® 174	¾ 190	Î 206	Ş 222	î 238	ş 254
F	SP 143	ÿ 159	– 175	¿ 191	Ï 207	ß 223	ï 239	ÿ 255

Page 49 (WPC1255: Hebrew)

HEX	8	9	A	B	C	D	E	F
0	€ 128	SP 144	SP 160	° 176	· 192	l 208	א 224	ג 240
1	SP 129	‘ 145	ı 161	± 177	ˆ 193	· 209	ב 225	ו 241
2	, 130	’ 146	¢ 162	² 178	˘ 194	· 210	ג 226	ע 242
3	f 131	“ 147	£ 163	³ 179	˙ 195	: 211	ד 227	ף 243
4	” 132	” 148	₪ 164	´ 180	· 196	ll 212	ה 228	פ 244
5	... 133	• 149	¥ 165	μ 181	˚ 197	ן 213	ו 229	ץ 245
6	† 134	– 150	ı 166	¶ 182	˘ 198	” 214	ז 230	צ 246
7	‡ 135	— 151	§ 167	· 183	˘ 199	’ 215	ח 231	ק 247
8	^ 136	˜ 152	ˆ 168	˘ 184	˘ 200	” 216	ט 232	ך 248
9	‰ 137	™ 153	© 169	¹ 185	· 201	SP 217	י 233	ש 249
A	SP 138	SP 154	× 170	÷ 186	SP 202	SP 218	ך 234	ת 250
B	‹ 139	› 155	« 171	» 187	ˆ 203	SP 219	כ 235	SP 251
C	SP 140	SP 156	¬ 172	¼ 188	· 204	SP 220	ל 236	SP 252
D	SP 141	SP 157	· 173	½ 189	· 205	SP 221	ם 237	SP 253
E	SP 142	SP 158	® 174	¾ 190	˘ 206	SP 222	נ 238	SP 254
F	SP 143	SP 159	– 175	¿ 191	˘ 207	SP 223	ן 239	SP 255

HEX	8	9	A	B	C	D	E	F
0	€ 128	گ 144	SP 160	° 176	ˆ 192	ذ 208	à 224	´ 240
1	ب 129	‘ 145	‘ 161	± 177	ء 193	ر 209	ل 225	” 241
2	، 130	’ 146	¢ 162	² 178	آ 194	ز 210	â 226	ˆ 242
3	f 131	“ 147	£ 163	³ 179	أ 195	س 211	م 227	˘ 243
4	” 132	” 148	¤ 164	´ 180	ؤ 196	ش 212	ن 228	ô 244
5	... 133	• 149	¥ 165	µ 181	إ 197	ص 213	ه 229	˘ 245
6	† 134	– 150	¡ 166	¶ 182	ئ 198	ض 214	و 230	˘ 246
7	‡ 135	— 151	§ 167	· 183	ا 199	× 215	ç 231	÷ 247
8	ˆ 136	ک 152	” 168	د 184	ب 200	ط 216	è 232	˘ 248
9	‰ 137	™ 153	© 169	¹ 185	ة 201	ظ 217	é 233	ù 249
A	ث 138	ژ 154	ه 170	؛ 186	ت 202	ع 218	ê 234	° 250
B	‹ 139	› 155	« 171	» 187	ث 203	غ 219	ë 235	û 251
C	Œ 140	œ 156	¬ 172	¼ 188	ج 204	- 220	ى 236	ü 252
D	چ 141	SP 157	173	½ 189	ح 205	ف 221	ي 237	SP 253
E	ژ 142	SP 158	® 174	¾ 190	خ 206	ق 222	î 238	SP 254
F	ث 143	س 159	– 175	؟ 191	د 207	ك 223	ï 239	ء 255

Page 51 (WPC1257: Baltic Rim)

HEX	8	9	A	B	C	D	E	F
0	€ 128	SP 144	SP 160	° 176	À 192	Š 208	ą 224	š 240
1	SP 129	‘ 145	SP 161	± 177	Ļ 193	Ņ 209	į 225	ń 241
2	, 130	’ 146	¢ 162	² 178	Ā 194	Ņ 210	ā 226	ņ 242
3	SP 131	“ 147	£ 163	³ 179	Ć 195	Ó 211	ć 227	ó 243
4	” 132	” 148	¤ 164	´ 180	Ä 196	Õ 212	ä 228	õ 244
5	... 133	• 149	SP 165	µ 181	Å 197	Õ 213	å 229	ö 245
6	† 134	– 150	ı 166	¶ 182	Ę 198	Ö 214	ę 230	ö 246
7	‡ 135	— 151	§ 167	· 183	Ē 199	× 215	ē 231	÷ 247
8	SP 136	SP 152	Ø 168	ø 184	Č 200	Ț 216	č 232	ț 248
9	‰ 137	™ 153	© 169	¹ 185	É 201	Ł 217	é 233	ł 249
A	SP 138	SP 154	Ŕ 170	ŗ 186	Ż 202	Ś 218	ż 234	ś 250
B	‹ 139	› 155	« 171	» 187	Ĕ 203	Ū 219	è 235	ū 251
C	SP 140	SP 156	¬ 172	¼ 188	Ğ 204	Ü 220	ğ 236	ü 252
D	¨ 141	– 157	173	½ 189	Ķ 205	Ž 221	ķ 237	ž 253
E	˘ 142	˙ 158	® 174	¾ 190	Ī 206	Ž 222	ī 238	ž 254
F	˚ 143	SP 159	Æ 175	æ 191	Ł 207	ß 223	ł 239	· 255

HEX	8	9	A	B	C	D	E	F
0	€ 128	SP 144	SP 160	° 176	À 192	Đ 208	à 224	đ 240
1	SP 129	‘ 145	ì 161	± 177	Á 193	Ñ 209	á 225	ñ 241
2	, 130	’ 146	ç 162	² 178	Â 194	² 210	â 226	² 242
3	f 131	“ 147	£ 163	³ 179	Ă 195	Ó 211	ă 227	ó 243
4	” 132	” 148	¤ 164	´ 180	Ä 196	Ô 212	ä 228	ô 244
5	... 133	• 149	¥ 165	µ 181	Å 197	Õ 213	å 229	õ 245
6	† 134	– 150	¡ 166	¶ 182	Æ 198	Ö 214	æ 230	ö 246
7	‡ 135	— 151	§ 167	· 183	Ç 199	× 215	ç 231	÷ 247
8	^ 136	~ 152	¨ 168	¸ 184	È 200	Ø 216	è 232	ø 248
9	‰ 137	™ 153	© 169	¹ 185	É 201	Ù 217	é 233	ù 249
A	SP 138	SP 154	ª 170	º 186	Ê 202	Ú 218	ê 234	ú 250
B	‹ 139	› 155	« 171	» 187	Ë 203	Û 219	ë 235	û 251
C	Œ 140	œ 156	¬ 172	¼ 188	´ 204	Ü 220	´ 236	ü 252
D	SP 141	SP 157	½ 173	½ 189	Í 205	Ů 221	í 237	ů 253
E	SP 142	SP 158	® 174	¾ 190	Î 206	˘ 222	î 238	đ 254
F	SP 143	ÿ 159	¯ 175	¿ 191	Ï 207	ß 223	ï 239	ÿ 255

Page 53 (KZ1048: Kazakhstan)

HEX	8	9	A	B	C	D	E	F
0	Љ 128	ђ 144	SP 160	° 176	А 192	Р 208	а 224	р 240
1	ѓ 129	‘ 145	Ў 161	± 177	Б 193	С 209	б 225	с 241
2	, 130	’ 146	ў 162	l 178	В 194	Т 210	в 226	т 242
3	ѓ 131	“ 147	Ә 163	i 179	Г 195	У 211	г 227	у 243
4	” 132	” 148	ӑ 164	ө 180	Д 196	Ф 212	д 228	ф 244
5	... 133	• 149	Ө 165	μ 181	Е 197	Х 213	е 229	х 245
6	† 134	— 150	ı 166	¶ 182	Ж 198	Ц 214	ж 230	ц 246
7	‡ 135	— 151	§ 167	· 183	З 199	Ч 215	з 231	ч 247
8	€ 136	SP 152	Ё 168	ё 184	И 200	Ш 216	и 232	ш 248
9	‰ 137	™ 153	© 169	№ 185	Й 201	Щ 217	й 233	щ 249
A	Ў 138	ў 154	Ғ 170	ғ 186	К 202	Ъ 218	к 234	ъ 250
B	‹ 139	› 155	« 171	» 187	Л 203	Ы 219	л 235	ы 251
C	Ң 140	ң 156	Ң 172	ө 188	М 204	Ь 220	м 236	ь 252
D	Қ 141	қ 157	- 173	Ң 189	Н 205	Э 221	н 237	э 253
E	Һ 142	һ 158	® 174	Ң 190	О 206	Ю 222	о 238	ю 254
F	Ҫ 143	ҫ 159	Ү 175	ү 191	П 207	Я 223	п 239	я 255

HEX	8	9	A	B	C	D	E	F
0	SP 128	SP 144	SP 160	SP 176	SP 192	SP 208	SP 224	SP 240
1	SP 129	SP 145	SP 161	SP 177	SP 193	SP 209	SP 225	SP 241
2	SP 130	SP 146	SP 162	SP 178	SP 194	SP 210	SP 226	SP 242
3	SP 131	SP 147	SP 163	SP 179	SP 195	SP 211	SP 227	SP 243
4	SP 132	SP 148	SP 164	SP 180	SP 196	SP 212	SP 228	SP 244
5	SP 133	SP 149	SP 165	SP 181	SP 197	SP 213	SP 229	SP 245
6	SP 134	SP 150	SP 166	SP 182	SP 198	SP 214	SP 230	SP 246
7	SP 135	SP 151	SP 167	SP 183	SP 199	SP 215	SP 231	SP 247
8	SP 136	SP 152	SP 168	SP 184	SP 200	SP 216	SP 232	SP 248
9	SP 137	SP 153	SP 169	SP 185	SP 201	SP 217	SP 233	SP 249
A	SP 138	SP 154	SP 170	SP 186	SP 202	SP 218	SP 234	SP 250
B	SP 139	SP 155	SP 171	SP 187	SP 203	SP 219	SP 235	SP 251
C	SP 140	SP 156	SP 172	SP 188	SP 204	SP 220	SP 236	SP 252
D	SP 141	SP 157	SP 173	SP 189	SP 205	SP 221	SP 237	SP 253
E	SP 142	SP 158	SP 174	SP 190	SP 206	SP 222	SP 238	SP 254
F	SP 143	SP 159	SP 175	SP 191	SP 207	SP 223	SP 239	SP 255

International Character Sets

Country	ASCII code (Hex)													
	23	24	25	2A	40	5B	5C	5D	5E	60	7B	7C	7D	7E
USA	#	\$	%	*	@	[¥]	^	`	{		}	~
France	#	\$	%	*	à	°	ç	§	^	`	é	ù	è	¨
Germany	#	\$	%	*	§	Ä	Ö	Ü	^	`	ä	ö	ü	ß
U.K.	£	\$	%	*	@	[¥]	^	`	{		}	~
Denmark I	#	\$	%	*	@	Æ	Ø	Å	^	`	æ	ø	å	~
Sweden	#	¤	%	*	É	Ä	Ö	Å	Ü	é	ä	ö	å	ü
Italy	#	\$	%	*	@	°	¥	é	^	ù	à	ò	è	ì
Spain I	Pt	\$	%	*	@	ı	Ñ	ı	^	`	¨	ñ	}	~
Japan	#	\$	%	*	@	[¥]	^	`	{		}	~
Norway	#	¤	%	*	É	Æ	Ø	Å	Ü	é	æ	ø	å	ü
Denmark II	#	\$	%	*	É	Æ	Ø	Å	Ü	é	æ	ø	å	ü
Spain II	#	\$	%	*	á	ı	Ñ	ı	é	`	ı	ñ	ó	ú
Latin America	#	\$	%	*	á	ı	Ñ	ı	é	ü	ı	ñ	ó	ú
Korea	#	\$	%	*	@	[₩]	^	`	{		}	~
Slovenia/Croatia	#	\$	%	*	Ž	Š	Đ	Ć	Č	ž	š	đ	ć	č
China	#	¥	%	*	@	[¥]	^	`	{		}	~
Vietnam	₫	\$	%	*	@	[¥]	^	`	{		}	~
Arabia	#	\$	%	*	@	[¥]	^	`	{		}	~

