

## FEATURES

- Temperature measurements require no external components
- Measures temperatures from  $-55^{\circ}\text{C}$  to  $+125^{\circ}\text{C}$  in  $0.5^{\circ}\text{C}$  increments. Fahrenheit equivalent is  $-67^{\circ}\text{F}$  to  $257^{\circ}\text{F}$  in  $0.9^{\circ}\text{F}$  increments
- Temperature is read as a 9-bit value (two byte transfer)
- Wide power supply range (2.7V to 5.5V)
- Converts temperature to digital word in 1 second
- Thermostatic settings are user definable and nonvolatile
- Data is read from/written via a 2-wire serial interface (open drain I/O lines)
- Applications include thermostatic controls, industrial systems, consumer products, thermometers, or any thermal sensitive system.
- 8-pin DIP or SOIC package (150 MIL and 208 MIL)

## DESCRIPTION

The DS1621 digital thermometer and thermostat provides 9-bit temperature readings which indicate the temperature of the device. The thermal alarm output,  $T_{\text{OUT}}$ , is active when the temperature of the device exceeds a user-defined temperature TH. The output remains active until the temperature drops below user defined temperature TL, allowing for any hysteresis necessary.

## PIN ASSIGNMENT

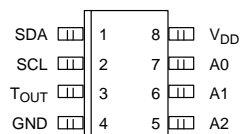

DS1621S 8-PIN SOIC (150 MIL)  
 DS1621V 8-PIN SOIC (208 MIL)  
 See Mech. Drawings  
 Section

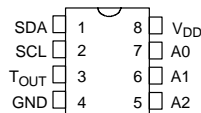

DS1621  
 8-PIN DIP (300 MIL)  
 See Mech. Drawings  
 Section

## PIN DESCRIPTION

SDA	– 2-Wire Serial Data Input/Output
SCL	– 2-Wire Serial Clock
GND	– Ground
$T_{\text{OUT}}$	– Thermostat Output Signal
A0	– Chip Address Input
A1	– Chip Address Input
A2	– Chip Address Input
$V_{\text{DD}}$	– Power Supply Voltage

User defined temperature settings are stored in non-volatile memory, so parts may be programmed prior to insertion in a system. Temperature settings, and temperature readings are all communicated to/from the DS1621 over a simple 2-wire serial interface.

**DETAILED PIN DESCRIPTION** Table 1

PIN	SYMBOL	DESCRIPTION
1	SDA	Data input/output pin for 2-wire serial communication port.
2	SCL	Clock input/output pin for 2-wire serial communication port.
3	T <sub>OUT</sub>	Thermostat output. Active when temperature exceeds TH; will reset when temperature falls below TL.
4	GND	Ground pin.
5	A2	Address input pin.
6	A1	Address input pin.
7	A0	Address input pin.
8	V <sub>DD</sub>	Supply voltage input power pin. (2.7V – 5.5V)

## OPERATION

### Measuring Temperature

A block diagram of the DS1621 is shown in Figure 1. The DS1621 measures temperatures through the use of an on-board proprietary temperature measurement technique. A block diagram of the temperature measurement circuitry is shown in Figure 2.

The DS1621 measures temperature by counting the number of clock cycles that an oscillator with a low temperature coefficient goes through during a gate period determined by a high temperature coefficient oscillator. The counter is preset with a base count that corresponds to  $-55^{\circ}\text{C}$ . If the counter reaches zero before the gate period is over, the temperature register, which is also preset to the  $-55^{\circ}\text{C}$  value, is incremented, indicating that the temperature is higher than  $-55^{\circ}\text{C}$ .

At the same time, the counter is then preset with a value determined by the slope accumulator circuitry. This circuitry is needed to compensate for the parabolic behavior of the oscillators over temperature. The counter is

then clocked again until it reaches zero. If the gate period is still not finished, then this process repeats.

The slope accumulator is used to compensate for the nonlinear behavior of the oscillators over temperature, yielding a high resolution temperature measurement. This is done by changing the number of counts necessary for the counter to go through for each incremental degree in temperature. To obtain the desired resolution, therefore, both the value of the counter and the number of counts per  $^{\circ}\text{C}$  (the value of the slope accumulator) at a given temperature must be known.

This calculation is done inside the DS1621 to provide  $0.5^{\circ}\text{C}$  resolution. The temperature reading is provided in a 9-bit, two's complement reading by issuing the READ TEMPERATURE command. Table 2 describes the exact relationship of output data to measured temperature. The data is transmitted through the 2-wire serial interface, MSB first. The DS1621 can measure temperature over the range of  $-55^{\circ}\text{C}$  to  $+125^{\circ}\text{C}$  in  $0.5^{\circ}\text{C}$  increments. For Fahrenheit usage, a lookup table or conversion factor must be used.

DS1621 FUNCTIONAL BLOCK DIAGRAM Figure 1

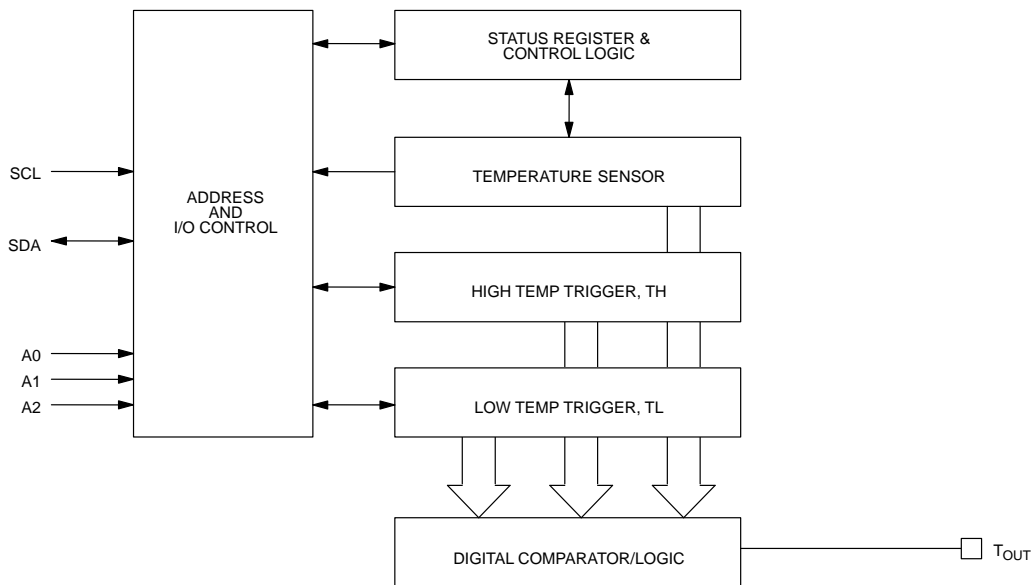

TEMPERATURE MEASURING CIRCUITRY Figure 2

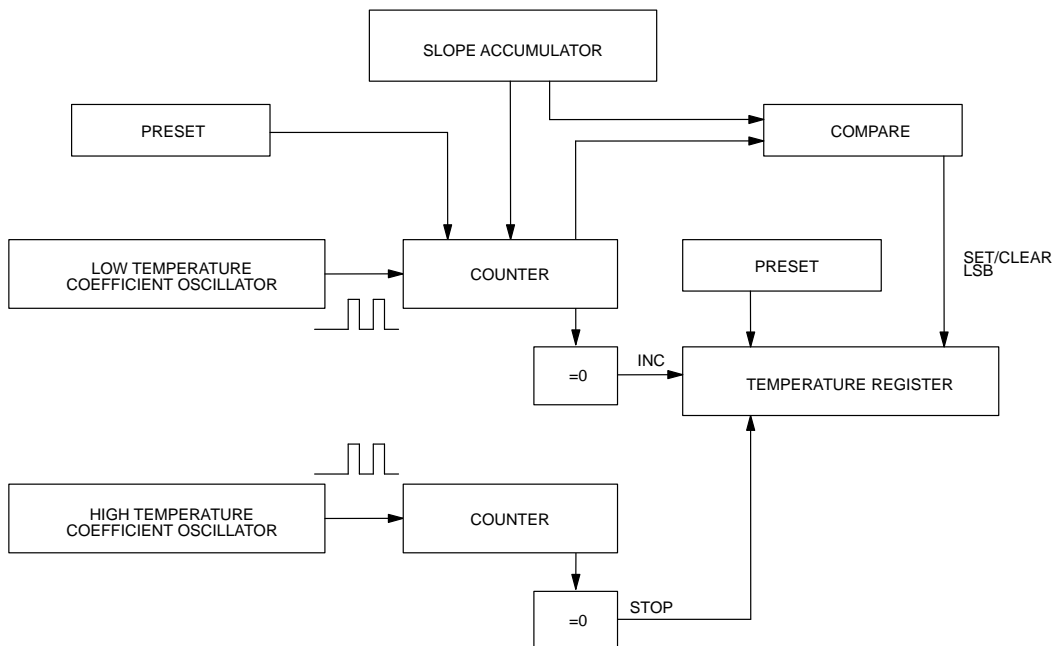

**TEMPERATURE/DATA RELATIONSHIPS** Table 2

TEMPERATURE	DIGITAL OUTPUT (Binary)	DIGITAL OUTPUT (Hex)
+125°C	01111101 00000000	7B00h
+25°C	00011001 00000000	1900h
+1/2°C	00000000 10000000	0080h
+0°C	00000000 00000000	0000h
-1/2°C	11111111 10000000	FF80h
-25°C	11100111 00000000	E700h
-55°C	11001001 00000000	C900h

Since data is transmitted over the 2-wire bus MSB first, temperature data may be written to/read from the DS1621 as either a single byte (with temperature resolution of 1°C), or as two bytes, the second byte containing the value of the least significant (0.5°C) bit of the temperature reading, as shown in Table 1. Note that the remaining 7 bits of this byte are set to all 0's.

Note that temperature is represented in the DS1621 in terms of a 1/2°C LSB, yielding the following 9-bit format:

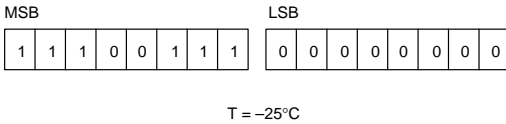

Higher resolutions may be obtained by reading the temperature, and truncating the 0.5°C bit (the LSB) from the read value. This value is TEMP\_READ. The value left in the counter may then be read by issuing a READ COUNTER command. This value is the count remaining (COUNT\_REMAIN) after the gate period has ceased. By loading the value of the slope accumulator into the count register (using the READ SLOPE command), this value may then be read, yielding the number of counts per degree C (COUNT\_PER\_C) at that temperature. The actual temperature may then be calculated by the user using the following:

$$\text{TEMPERATURE} = \text{TEMP\_READ} - 0.25 + \frac{(\text{COUNT\_PER\_C} - \text{COUNT\_REMAIN})}{\text{COUNT\_PER\_C}}$$

### Thermostat Control

In its operating mode, the DS1621 functions as a thermostat with programmable hysteresis, as shown in Figure 3. The thermostat output updates as soon as a temperature conversion is complete.

When the DS1621's temperature meets or exceeds the value stored in the high temperature trip register (TH), the output becomes active, and will stay active until the temperature falls below the temperature stored in the low temperature trigger register (TL). In this way, any amount of hysteresis may be obtained.

The active state for the output is programmable by the user, so that an active state may either be a logic 1 (V<sub>DD</sub>) or a logic 0 (0V).

### THERMOSTAT OUTPUT OPERATION

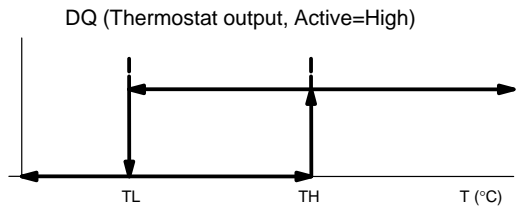
 Figure 3

## OPERATION AND CONTROL

The DS1621 must have temperature settings resident in the TH and TL registers for thermostatic operation. A configuration/status register is also used to determine the method of operation that the DS1621 will use in a particular application, as well as indicating the status of the temperature conversion operation.

The configuration register is defined as follows:

CONFIGURATION/STATUS REGISTER

DONE	THF	TLF	NVB	1	0	POL	1SHOT
------	-----	-----	-----	---	---	-----	-------

where

**DONE** = Conversion Done bit. “1” = Conversion complete, “0” = conversion in progress.

**THF** = Temperature High Flag. This bit will be set to “1” when the temperature is greater than or equal to the value of TH. It will remain “1” until reset by writing 0 into this location or removing power from the device. This feature provides a method of determining if the DS1621 has ever been subjected to temperatures above TH while power has been applied.

**TLF** = Temperature Low Flag. This bit will be set to “1” when the temperature is less than or equal to the value of TL. It will remain “1” until reset by writing 0 into this location or removing power from the device. This feature provides a method of determining if the DS1621 has ever been subjected to temperatures below TL while power has been applied.

**NVB** = Nonvolatile memory busy flag. “1” = Write to an E<sup>2</sup> memory cell in progress, “0” = nonvolatile memory is not busy. A copy to E<sup>2</sup> may take up to 10 ms.

**POL** = Output Polarity Bit. “1” = active high, “0” = active low. This bit is nonvolatile.

**1SHOT** = One Shot Mode. If 1SHOT is “1”, the DS1621 will perform one temperature conversion upon reception of the Start Convert T protocol. If 1SHOT is “0”, the DS1621 will continuously perform temperature conversions. This bit is nonvolatile.

For typical thermostat operation, the DS1621 will operate in continuous mode. However, for applications

where only one reading is needed at certain times, and to conserve power, the one-shot mode may be used. Note that the thermostat output (T<sub>OUT</sub>) will remain in the state it was in after the last valid temperature conversion cycle when operating in one-shot mode.

## 2-WIRE SERIAL DATA BUS

The DS1621 supports a bi-directional two-wire bus and data transmission protocol. A device that sends data onto the bus is defined as a transmitter, and a device receiving data as a receiver. The device that controls the message is called a “master”. The devices that are controlled by the master are “slaves”. The bus must be controlled by a master device which generates the serial clock (SCL), controls the bus access, and generates the START and STOP conditions. The DS1621 operates as a slave on the two-wire bus. Connections to the bus are made via the open-drain I/O lines SDA and SCL.

The following bus protocol has been defined (See Figure 4):

- Data transfer may be initiated only when the bus is not busy.
- During data transfer, the data line must remain stable whenever the clock line is HIGH. Changes in the data line while the clock line is high will be interpreted as control signals.

Accordingly, the following bus conditions have been defined:

**Bus not busy:** Both data and clock lines remain HIGH.

**Start data transfer:** A change in the state of the data line, from HIGH to LOW, while the clock is HIGH, defines a START condition.

**Stop data transfer:** A change in the state of the data line, from LOW to HIGH, while the clock line is HIGH, defines the STOP condition.

**Data valid:** The state of the data line represents valid data when, after a START condition, the data line is stable for the duration of the HIGH period of the clock signal. The data on the line must be changed during the LOW period of the clock signal. There is one clock pulse per bit of data.

Each data transfer is initiated with a START condition and terminated with a STOP condition. The number of data bytes transferred between START and STOP conditions is not limited, and is determined by the master device. The information is transferred byte-wise and each receiver acknowledges with a ninth-bit.

Within the bus specifications a regular mode (100 KHz clock rate) and a fast mode (400 KHz clock rate) are defined. The DS1621 works in both modes.

**Acknowledge:** Each receiving device, when addressed, is obliged to generate an acknowledge after the reception of each byte. The master device must gen-

erate an extra clock pulse which is associated with this acknowledge bit.

A device that acknowledges must pull down the SDA line during the acknowledge clock pulse in such a way that the SDA line is stable LOW during the HIGH period of the acknowledge related clock pulse. Of course, setup and hold times must be taken into account. A master must signal an end of data to the slave by not generating an acknowledge bit on the last byte that has been clocked out of the slave. In this case, the slave must leave the data line HIGH to enable the master to generate the STOP condition.

## DATA TRANSFER ON 2-WIRE SERIAL BUS Figure 4

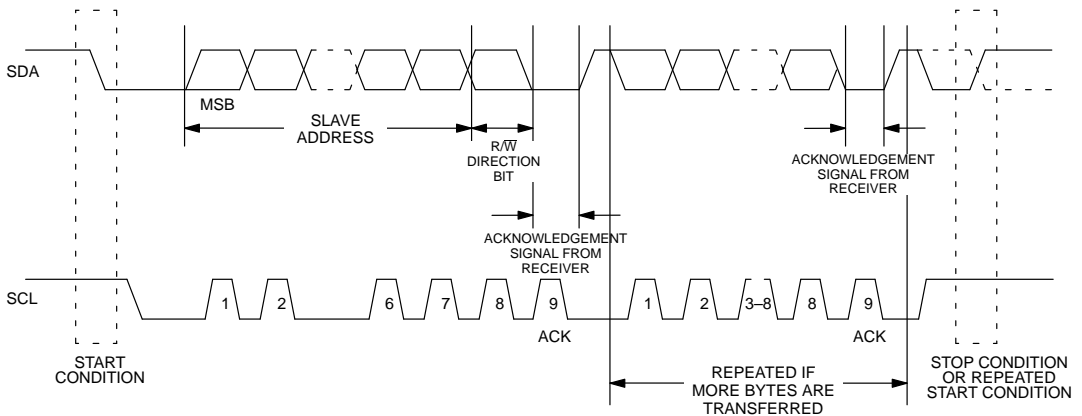

Figure 4 details how data transfer is accomplished on the two-wire bus. Depending upon the state of the R/W bit, two types of data transfer are possible:

1. **Data transfer from a master transmitter to a slave receiver.** The first byte transmitted by the master is the slave address. Next follows a number of data bytes. The slave returns an acknowledge bit after each received byte.
2. **Data transfer from a slave transmitter to a master receiver.** The first byte (the slave address) is transmitted by the master. The slave then returns an acknowledge bit. Next follows a number of data bytes transmitted by the slave to the master. The master returns an acknowledge bit after all received bytes other than the last byte. At the end of the last received byte, a 'not acknowledge' is returned.

The master device generates all of the serial clock pulses and the START and STOP conditions. A transfer is ended with a STOP condition or with a repeated START condition. Since a repeated START condition is also the beginning of the next serial transfer, the bus will not be released.

The DS1621 may operate in the following two modes:

1. **Slave receiver mode:** Serial data and clock are received through SDA and SCL. After each byte is received, an acknowledge bit is transmitted. START and STOP conditions are recognized as the beginning and end of a serial transfer. Address recognition is performed by hardware after reception of the slave address and direction bit.
2. **Slave transmitter mode:** The first byte is received and handled as in the slave receiver mode. However, in this mode, the direction bit will indicate that the transfer direction is reversed. Serial data is transmitted on SDA by the DS1621 while the serial clock is input on SCL. START and STOP conditions are recognized as the beginning and end of a serial transfer.

## SLAVE ADDRESS

A control byte is the first byte received following the START condition from the master device. The control byte consists of a four bit control code; for the DS1621, this is set as 1001 binary for read and write operations. The next three bits of the control byte are the device select bits (A2, A1, A0). They are used by the master device to select which of eight devices are to be accessed. These bits are in effect the three least significant bits of the slave address. The last bit of the control byte ( $R/\bar{W}$ ) defines the operation to be performed. When set to a one a read operation is selected, and when set to a zero a write operation is selected. Following the START condition, the DS1621 monitors the SDA bus checking the device type identifier being transmitted. Upon receiving the 1001 code and appropriate device select bits, the slave device outputs an acknowledge signal on the SDA line.

2-WIRE SERIAL COMMUNICATION WITH DS1621 Figure 5

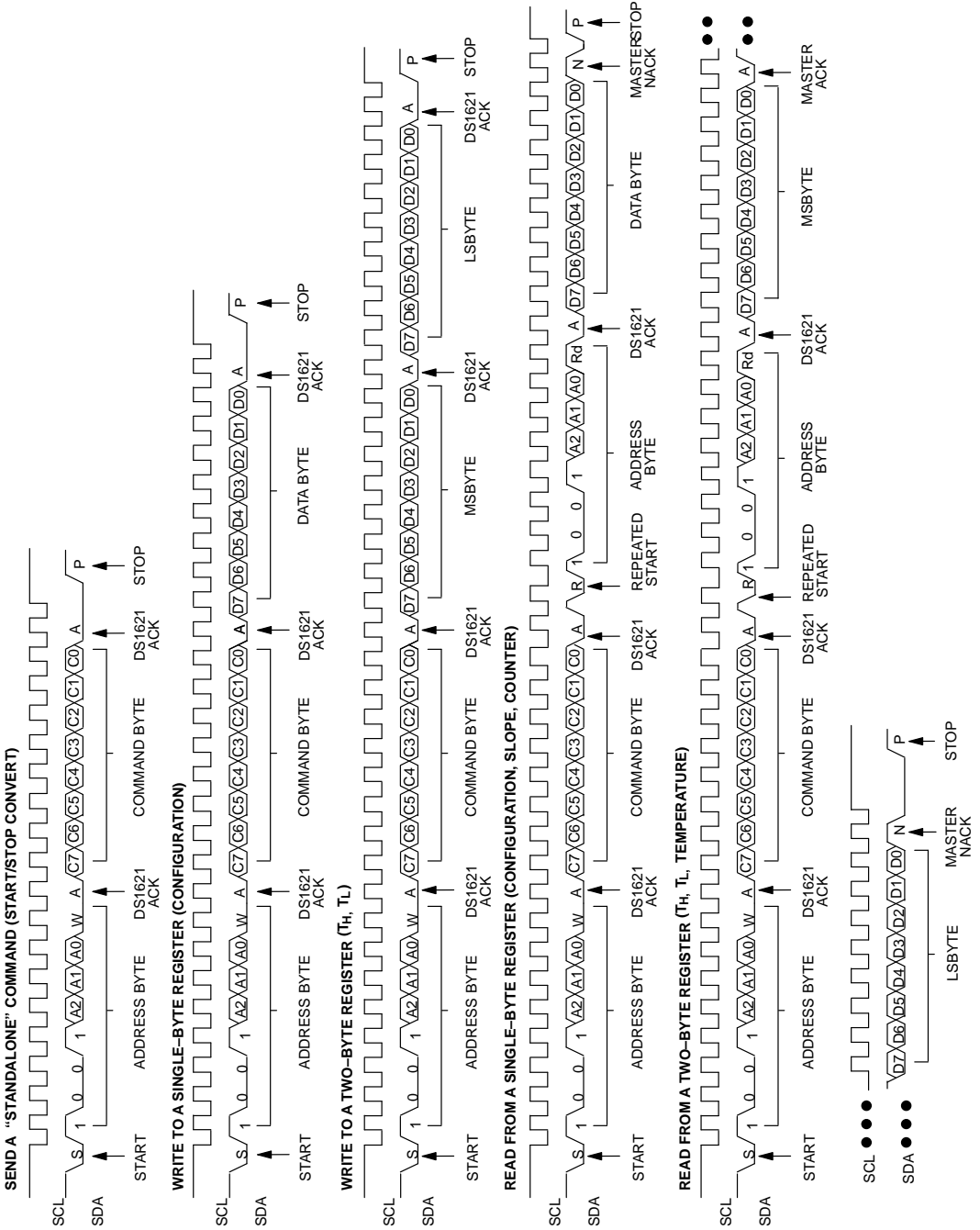



## COMMAND SET

Data and control information is read from and written to the DS1621 in the format shown in Figure 5. To write to the DS1621, the master will issue the slave address of the DS1621, and the  $R/\bar{W}$  bit will be set to 0. After receiving an acknowledge, the bus master provides a command protocol. After receiving this protocol, the DS1621 will issue an acknowledge, and then the master may send data to the DS1621. If the DS1621 is to be read, the master must send the command protocol as before, and then issue a repeated START condition and the control byte again, this time with the  $R/\bar{W}$  bit set to 1 to allow reading of the data from the DS1621. The command set for the DS1621 as shown in Table 3 is as follows:

### Read Temperature [AAh]

This command reads the last temperature conversion result. The DS1621 will send two bytes, in the format described earlier, which are the contents of this register.

### Access TH [A1h]

If  $R/\bar{W}$  is 0, this command writes to the TH (HIGH TEMPERATURE) register. After issuing this command, the next two bytes written to the DS1621, in the same format as described for reading temperature, will set the high temperature threshold for operation of the  $T_{OUT}$  output. If  $R/\bar{W}$  is 1, the value stored in this register is read back.

### Access TL [A2h]

If  $R/\bar{W}$  is 0, this command writes to the TL (LOW TEMPERATURE) register. After issuing this command, the next two bytes written to the DS1621, in the same format as described for reading temperature, will set the high

temperature threshold for operation of the  $T_{OUT}$  output. If  $R/\bar{W}$  is 1, the value stored in this register is read back.

### Access Config [ACh]

If  $R/\bar{W}$  is 0, this command writes to the configuration register. After issuing this command, the next data byte is the value to be written into the configuration register. If  $R/\bar{W}$  is 1, the next data byte read is the value stored in the configuration register.

### Read Counter [A8h]

This command reads the value of the counter byte. This command is valid only if  $R/\bar{W}$  is 1.

### Read Slope [A9h]

This command reads the value of the slope counter byte from the DS1621. This command is valid only if  $R/\bar{W}$  is 1.

### Start Convert T [EEh]

This command begins a temperature conversion. No further data is required. In one-shot mode, the temperature conversion will be performed and then the DS1621 will remain idle. In continuous mode, this command will initiate continuous conversions.

### Stop Convert T [22h]

This command stops temperature conversion. No further data is required. This command may be used to halt a DS1621 in continuous conversion mode. After issuing this command, the current temperature measurement will be completed, and then the DS1621 will remain idle until a Start Convert T is issued to resume continuous operation.

**DS1621 COMMAND SET** Table 3

INSTRUCTION	DESCRIPTION	PROTOCOL	2-WIRE BUS DATA AFTER ISSUING PROTOCOL	NOTES
<b>TEMPERATURE CONVERSION COMMANDS</b>				
Read Temperature	Read last converted temperature value from temperature register.	AAh	<read 2 bytes data>	
Read Counter	Reads value of count remaining from counter.	A8h	<read data>	
Read Slope	Reads value of the slope accumulator.	A9h	<read data>	
Start Convert T	Initiates temperature conversion.	EEh	idle	1
Stop Convert T	Halts temperature conversion.	22h	idle	1
<b>THERMOSTAT COMMANDS</b>				
Access TH	Reads or writes high temperature limit value into TH register.	A1h	<write data>	2
Access TL	Reads or writes low temperature limit value into TL register.	A2h	<write data>	2
Access Config	Reads or writes configuration data to configuration register.	ACh	<write data>	2

**NOTES:**

1. In continuous conversion mode, a Stop Convert T command will halt continuous conversion. To restart, the Start Convert T command must be issued. In one-shot mode, a Start Convert T command must be issued for every temperature reading desired.
2. Writing to the E<sup>2</sup> typically requires 10ms at room temperature. After issuing a write command, no further writes should be requested for at least 10 ms.

**MEMORY FUNCTION EXAMPLE**

Example: Bus master sets up DS1621 for continuous conversion and thermostatic function.

BUS MASTER MODE	DS1621 MODE	DATA (MSB FIRST)	COMMENTS
TX	RX	START	Bus Master initiates a START condition.
TX	RX	<address,0>	Bus Master sends DS1621 address; $R/\overline{W} = 0$ .
RX	TX	ACK	DS1621 generates acknowledge bit.
TX	RX	ACh	Bus Master sends Access Config command protocol.
RX	TX	ACK	DS1621 generates acknowledge bit.
TX	RX	02h	Bus Master sets up DS1621 for output polarity active high, continuous conversion.
RX	TX	ACK	DS1621 generates acknowledge bit.
TX	RX	START	Bus Master generates a repeated START condition.
TX	RX	<address,0>	Bus Master sends DS1621 address; $R/\overline{W} = 0$ .
RX	TX	ACK	DS1621 generates acknowledge bit.
TX	RX	A1h	Bus Master sends Access TH command.
RX	TX	ACK	DS1621 generates acknowledge bit.
TX	RX	28h	Bus Master sends first byte of data for TH limit of +40°C.
RX	TX	ACK	DS1621 generates acknowledge bit.
TX	RX	00h	Bus Master sends second byte of data for TH limit of +40°C.
RX	TX	ACK	DS1621 generates acknowledge bit.
TX	RX	START	Bus Master generates a repeated START condition.
TX	RX	<address,0>	Bus Master sends DS1621 address; $R/\overline{W} = 0$ .
RX	TX	ACK	DS1621 generates acknowledge bit.
TX	RX	A2h	Bus Master sends Access TL command.
RX	TX	ACK	DS1621 generates acknowledge bit.
TX	RX	0Ah	Bus Master sends first byte of data for TL limit of +10°C.
RX	TX	ACK	DS1621 generates acknowledge bit.
TX	RX	00h	Bus Master sends second byte of data for TL limit of +10°C.
RX	TX	ACK	DS1621 generates acknowledge bit.
TX	RX	START	Bus Master generates a repeated START condition.
TX	RX	<address,0>	Bus Master sends DS1621 address; $R/\overline{W} = 0$ .
RX	TX	ACK	DS1621 generates acknowledge bit.
TX	RX	Eeh	Bus Master sends Start Convert T command protocol.
RX	TX	ACK	DS1621 generates acknowledge bit.
TX	RX	STOP	Bus Master initiates STOP condition.

**ABSOLUTE MAXIMUM RATINGS\***

Voltage on Any Pin Relative to Ground	-0.5V to +7.0V
Operating Temperature	-55°C to +125°C
Storage Temperature	-55°C to +125°C
Soldering Temperature	260°C for 10 seconds

\* This is a stress rating only and functional operation of the device at these or any other conditions above those indicated in the operation sections of this specification is not implied. Exposure to absolute maximum rating conditions for extended periods of time may affect reliability.

**RECOMMENDED DC OPERATING CONDITIONS**

PARAMETER	SYMBOL	MIN	TYP	MAX	UNITS	NOTES
Supply Voltage	$V_{DD}$	2.7		5.5	V	1

**DC ELECTRICAL CHARACTERISTICS**

(-55°C to +125°C;  $V_{DD}=2.7V$  to 5.5V)

PARAMETER	SYMBOL	CONDITION	MIN	TYP	MAX	UNITS	NOTES
Thermometer Error	$T_{ERR}$	0°C to 70°C			$\pm 1/2$	°C	11
Low Level Input Voltage	$V_{IL}$		-0.5		$0.3 V_{DD}$	V	
High Level Input Voltage	$V_{IH}$		$0.7 V_{DD}$		$V_{DD}+0.5$	V	
Pulse width of spikes which must be suppressed by the input filter	$t_{SP}$	Fast Mode	0		50	ns	
Low Level Output Voltage	$V_{OL1}$	3 mA sink current	0		0.4	V	
	$V_{OL2}$	6 mA sink current	0		0.6	V	
Input Current each I/O Pin		$0.4 < V_{IO} < 0.9 V_{DD}$	-10		10	$\mu A$	2
I/O Capacitance	$C_{I/O}$				10	pF	
Active Supply Current	$I_{CC}$	Temperature Conversion E <sup>2</sup> Write Communication Only			1000	$\mu A$	3, 4
					400		
					100		
Standby Supply Current	$I_{STBY}$				1	$\mu A$	3, 4
Thermostat Output ( $T_{OUT}$ ) Output Voltage	$V_{OH}$	1 mA source	2.4			V	
	$V_{OL}$	4 mA sink			0.4	V	

**AC ELECTRICAL CHARACTERISTICS**(-55°C to +125°C;  $V_{DD}=2.7V$  to 5.5V)

PARAMETER	SYMBOL	CONDITION	MIN	TYP	MAX	UNITS	NOTES
Temperature Conversion Time	$T_{TC}$			0.4	1	s	
NV Write Cycle Time	$t_{WR}$	0°C to 70°C		10	50	ms	10
SCL Clock Frequency	$f_{SCL}$	Fast Mode Standard Mode	0 0		400 100	KHz	
Bus Free Time Between a STOP and START Condition	$t_{BUF}$	Fast Mode Standard Mode	1.3 4.7			$\mu$ s	
Hold Time (Repeated) START Condition	$t_{HD:STA}$	Fast Mode Standard Mode	0.6 4.0			$\mu$ s	5
Low Period of SCL Clock	$t_{LOW}$	Fast Mode Standard Mode	1.3 4.7			$\mu$ s	
High Period of SCL Clock	$t_{HIGH}$	Fast Mode Standard Mode	0.6 4.0			$\mu$ s	
Setup Time for a Repeated START Condition	$t_{SU:STA}$	Fast Mode Standard Mode	0.6 4.7			$\mu$ s	
Data Hold Time	$t_{HD:DAT}$	Fast Mode Standard Mode	0 0		0.9	$\mu$ s	6, 7
Data Setup Time	$t_{SU:DAT}$	Fast Mode Standard Mode	100 250			ns	8
Rise Time of both SDA and SCL Signals	$t_R$	Fast Mode Standard Mode	$20+0.1C_B$		300 1000	ns	9
Fall Time of both SDA and SCL Signals	$t_F$	Fast Mode Standard Mode	$20+0.1C_B$		300 300	ns	9
Setup time for STOP Condition	$t_{SU:STO}$	Fast Mode Standard Mode	0.6 4.0			$\mu$ s	
Capacitive Load for each Bus Line	$C_B$				400	pF	

All values referred to  $V_{IH}=0.9 V_{DD}$  and  $V_{IL}=0.1 V_{DD}$ .**AC ELECTRICAL CHARACTERISTICS**(-55°C to +125°C;  $V_{DD}=2.7V$  to 5.5V)

PARAMETER	SYMBOL	MIN	TYP	MAX	UNITS	NOTES
Input Capacitance	$C_I$		5		pF	

**NOTES:**

1. All voltages are referenced to ground.
2. I/O pins of fast mode devices must not obstruct the SDA and SCL lines if  $V_{DD}$  is switched off.
3.  $I_{CC}$  specified with  $T_{OUT}$  pin open.
4.  $I_{CC}$  specified with  $V_{CC}$  at 5.0V and SDA, SCL = 5.0V, 0°C to 70°C.

5. After this period, the first clock pulse is generated.
6. A device must internally provide a hold time of at least 300 ns for the SDA signal (referred to the  $V_{IH\ MIN}$  of the SCL signal) in order to bridge the undefined region of the falling edge of SCL.
7. The maximum  $t_{HD:DAT}$  has only to be met if the device does not stretch the LOW period ( $t_{LOW}$ ) of the SCL signal.
8. A fast mode device can be used in a standard mode system, but the requirement  $t_{SU:DAT} > 250$  ns must then be met. This will automatically be the case if the device does not stretch the LOW period of the SCL signal. If such a device does stretch the LOW period of the SCL signal, it must output the next data bit to the SDA line  $t_{R\ MAX} + t_{SU:DAT} = 1000 + 250 = 1250$  ns before the SCL line is released.
9.  $C_b$  – total capacitance of one bus line in pF.
10. Writing to the nonvolatile memory should only take place in the 0°C to 70°C temperature range.
11. See typical curve for specification limits outside 0°C to 70°C range. Thermometer error reflects sensor accuracy as tested during calibration.

## TIMING DIAGRAM

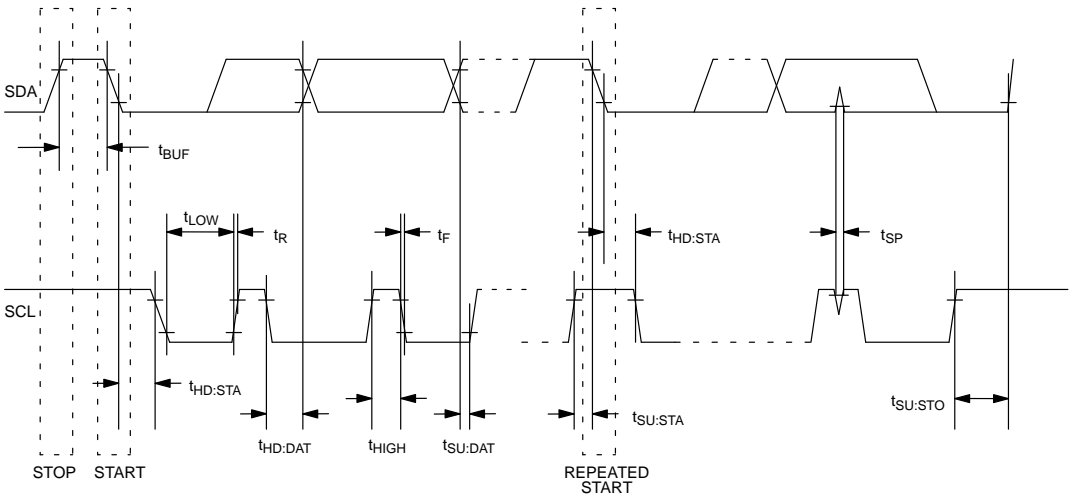

**TYPICAL PERFORMANCE CURVE****DS1621 DIGITAL THERMOMETER AND THERMOSTAT  
TEMPERATURE READING ERROR**