

150-mA, ULTRA-LOW QUIESCENT CURRENT, 1- μ A I_Q LOW-DROPOUT LINEAR REGULATOR

 Check for Samples: [TPS78225-Q1](#) [TPS78227-Q1](#) [TPS78228-Q1](#) [TPS78230-Q1](#)

FEATURES

- Qualified for Automotive Applications
- Low I_Q : 1 μ A
- 150-mA Low-Dropout Regulator
- Low Dropout at 25°C: 130 mV at 150 mA
- Low Dropout at 85°C: 175 mV at 150 mA
- 4% Accuracy Over Load/Line/Temperature
- Available in Fixed Voltage Options (2.5 V, 2.7 V, 2.8 V, and 3 V) Using Innovative Factory EEPROM Programming
- Stable with a 1- μ F Ceramic Capacitor
- Thermal Shutdown and Overcurrent Protection
- CMOS Logic Level Compatible Enable Pin
- Available in DDC (TSOT23-5) or DRV (2-mm x 2-mm SON-6) Packages

APPLICATIONS

- TI [MSP430](#) Attach Applications
- Power Rails with Programming Mode

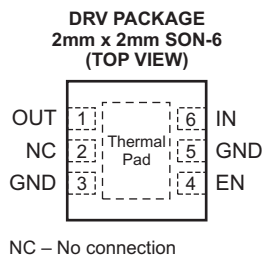

DESCRIPTION

The TPS782xx family of low-dropout regulators (LDOs) offers the benefits of ultra-low power ($I_Q = 1 \mu\text{A}$), and miniaturized packaging (2-mm \times 2-mm SON).

This LDO is designed specifically for battery-powered applications where ultra-low quiescent current is a critical parameter. The TPS782, with ultra-low I_Q (1 μA), is ideal for microprocessors, memory cards, and smoke detectors.

The ultra-low power and miniaturized packaging allow designers to customize power consumption for specific applications. Consult with your local factory representative for exact voltage options and ordering information; minimum order quantities may apply.

The TPS782xx family is designed to be compatible with the TI [MSP430](#) and other similar products. The enable pin (EN) is compatible with standard CMOS logic. This LDO is stable with any output capacitor greater than 1.0 μF . Therefore, this device requires minimal board space because of miniaturized packaging and a potentially small output capacitor. The TPS782xx series also features thermal shutdown and current limit to protect the device during fault conditions. The devices have an operating temperature range of $T_J = -40^\circ\text{C}$ to 125°C . For high-performance applications that require a dual-level voltage option, consider the [TPS780 series](#), with an I_Q of 500 nA and dynamic voltage scaling.

ORDERING INFORMATION⁽¹⁾

T_J	PACKAGE ⁽²⁾		ORDERABLE PART NUMBER	TOP-SIDE MARKING
-40°C to 125°C	SON – DRV	Reel of 3000	TPS78225QDRVRQ1	NSY
			TPS78227QDRVRQ1	OFH
			TPS78228QDRVRQ1	OFI
			TPS78230QDRVRQ1	OFJ

(1) For the most current package and ordering information, see the Package Option Addendum at the end of this document, or see the TI web site at www.ti.com.

(2) Package drawings, thermal data, and symbolization are available at www.ti.com/packaging.



Please be aware that an important notice concerning availability, standard warranty, and use in critical applications of Texas Instruments semiconductor products and disclaimers thereto appears at the end of this data sheet.

All trademarks are the property of their respective owners.



This integrated circuit can be damaged by ESD. Texas Instruments recommends that all integrated circuits be handled with appropriate precautions. Failure to observe proper handling and installation procedures can cause damage.

ESD damage can range from subtle performance degradation to complete device failure. Precision integrated circuits may be more susceptible to damage because very small parametric changes could cause the device not to meet its published specifications.

ABSOLUTE MAXIMUM RATINGS⁽¹⁾

At $T_J = -40^{\circ}\text{C}$ to 125°C , unless otherwise noted. All voltages are with respect to GND.

	TPS782xx	UNIT
Input voltage range, V_{IN}	-0.3 to +6.0	V
Enable	-0.3 to $V_{IN} + 0.3\text{V}$	V
Output voltage range, V_{OUT}	-0.3 to $V_{IN} + 0.3\text{V}$	V
Maximum output current, I_{OUT}	Internally limited	
Output short-circuit duration	Indefinite	
Total continuous power dissipation, P_{DISS}	See the Dissipation Ratings table	
ESD rating	Human body model (HBM)	2 kV
	Charged device model (CDM)	500 V
Operating junction temperature range, T_J	-40 to 125	$^{\circ}\text{C}$
Storage temperature range, T_{STG}	-55 to +150	$^{\circ}\text{C}$

- (1) Stresses above these ratings may cause permanent damage. Exposure to absolute maximum conditions for extended periods may degrade device reliability. These are stress ratings only, and functional operation of the device at these or any other conditions beyond those specified is not implied.

DISSIPATION RATINGS

BOARD	PACKAGE	$R_{\theta JC}$	$R_{\theta JA}$	DERATING FACTOR ABOVE $T_A = 25^{\circ}\text{C}$	$T_A < 25^{\circ}\text{C}$	$T_A = 70^{\circ}\text{C}$	$T_A = 85^{\circ}\text{C}$
High-K ⁽¹⁾	DRV	$20^{\circ}\text{C}/\text{W}$	$65^{\circ}\text{C}/\text{W}$	$15.4 \text{ mW}/^{\circ}\text{C}$	1540 mW	84 5mW	615 mW

- (1) The JEDEC high-K (2s2p) board used to derive this data was a 3-inch x 3-inch, multilayer board with 1-ounce internal power and ground planes and 2-ounce copper traces on top and bottom of the board.

ELECTRICAL CHARACTERISTICS

$T_J = -40^{\circ}\text{C}$ to 125°C , $V_{IN} = V_{OUT(NOM)} + 0.5\text{ V}$ or 2.2 V , whichever is greater; $I_{OUT} = 100\ \mu\text{A}$, $V_{EN} = V_{IN}$, $C_{OUT} = 1.0\ \mu\text{F}$, fixed V_{OUT} test conditions (unless otherwise noted). Typical values at $T_J = 25^{\circ}\text{C}$.

PARAMETER		TEST CONDITIONS	TPS782xx			UNIT	
			MIN	TYP	MAX		
V_{IN}	Input voltage range		2.2		5.5	V	
V_{OUT}	DC output accuracy	Nominal	$T_J = 25^{\circ}\text{C}$			%	
		Over V_{IN} , I_{OUT} , temperature	$V_{OUT} + 0.5\text{ V} \leq V_{IN} \leq 5.5\text{ V}$, $5\text{ mA} \leq I_{OUT} \leq 150\text{ mA}$			%	
$\Delta V_{OUT}/\Delta V_{IN}$	Line regulation	$V_{OUT(NOM)} + 0.5\text{ V} \leq V_{IN} \leq 5.5\text{ V}$, $I_{OUT} = 5\text{ mA}$	± 1			%	
$\Delta V_{OUT}/\Delta I_{OUT}$	Load regulation	$0\text{ mA} \leq I_{OUT} \leq 150\text{ mA}$	± 2			%	
V_{DO}	Dropout voltage ⁽¹⁾	$V_{IN} = 95\% V_{OUT(NOM)}$, $I_{OUT} = 150\text{ mA}$	130	250		mV	
V_N	Output noise voltage	$BW = 100\text{ Hz to }100\text{ kHz}$, $V_{IN} = 2.2\text{ V}$, $V_{OUT} = 1.2\text{ V}$, $I_{OUT} = 1\text{ mA}$	86			μV_{RMS}	
I_{CL}	Output current limit	$V_{OUT} = 0.90 \times V_{OUT(NOM)}$	150	230	400	mA	
I_{GND}	Ground pin current	$I_{OUT} = 0\text{ mA}$	1			μA	
		$I_{OUT} = 150\text{ mA}$	8			μA	
I_{SHDN}	Shutdown current (I_{GND})	$V_{EN} \leq 0.4\text{ V}$, $2.2\text{ V} \leq V_{IN} < 5.5\text{ V}$, $T_J = 25^{\circ}\text{C}$	18			130	nA
I_{EN}	EN pin current	$V_{EN} = 5.5\text{ V}$, $T_J = 25^{\circ}\text{C}$				40	nA
PSRR	Power-supply rejection ratio	$V_{IN} = 4.3\text{ V}$, $V_{OUT} = 3.3\text{ V}$, $I_{OUT} = 150\text{ mA}$	$f = 10\text{ Hz}$	40		dB	
			$f = 100\text{ Hz}$	20		dB	
			$f = 1\text{ kHz}$	15		dB	
t_{STR}	Startup time ⁽²⁾	$C_{OUT} = 1.0\ \mu\text{F}$, $V_{OUT} = 10\% V_{OUT(NOM)}$ to $V_{OUT} = 90\% V_{OUT(NOM)}$	500			μs	
t_{SHDN}	Shutdown time ⁽³⁾	$I_{OUT} = 150\text{ mA}$, $C_{OUT} = 1.0\ \mu\text{F}$, $V_{OUT} = 2.8\text{ V}$, $V_{OUT} = 90\% V_{OUT(NOM)}$ to $V_{OUT} = 10\% V_{OUT(NOM)}$	500 ⁽⁴⁾			μs	
T_{SD}	Thermal shutdown temperature	Shutdown, temperature increasing	160			$^{\circ}\text{C}$	
		Reset, temperature decreasing	140			$^{\circ}\text{C}$	
T_J	Operating junction temperature		-40		125	$^{\circ}\text{C}$	

(1) V_{DO} is not measured for devices with $V_{OUT(NOM)} \leq 2.3\text{ V}$, because minimum $V_{IN} = 2.2\text{ V}$.

(2) Time from $V_{EN} = 1.2\text{ V}$ to $V_{OUT} = 90\% (V_{OUT(NOM)})$.

(3) Time from $V_{EN} = 0.4\text{ V}$ to $V_{OUT} = 10\% (V_{OUT(NOM)})$.

(4) See [Shutdown](#) in the [Application Information](#) section for more details.

FUNCTIONAL BLOCK DIAGRAM

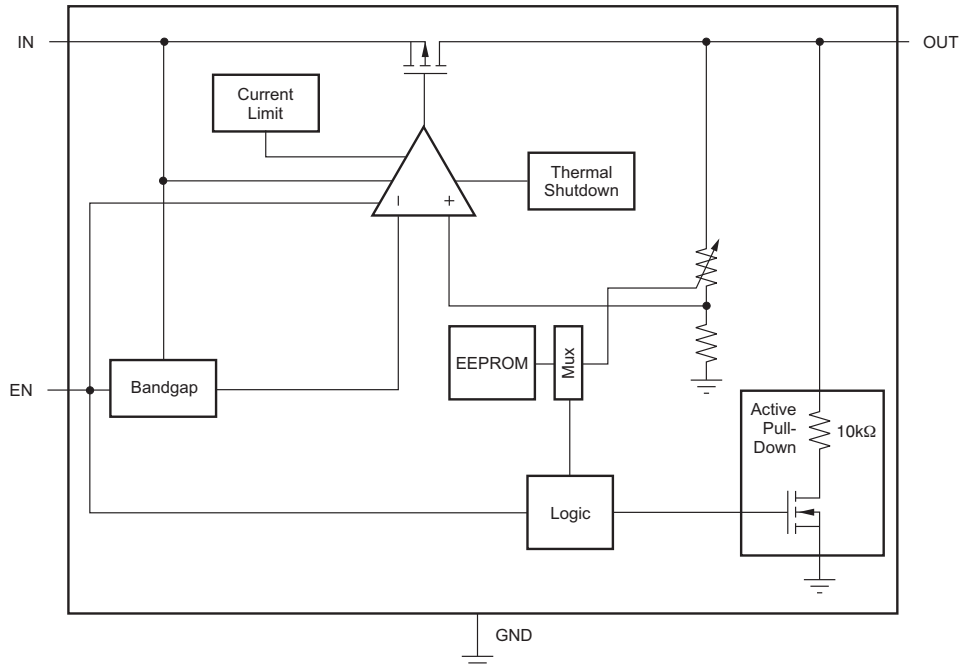

PIN CONFIGURATIONS

DRV PACKAGE
 2mm x 2mm SON-6
 (TOP VIEW)

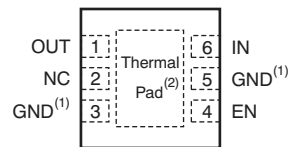

- (1) All ground pins must be connected to ground for proper operation.
- (2) It is recommended that the thermal pad be grounded.

Table 1. PIN DESCRIPTIONS

NAME	NO.	DESCRIPTION
OUT	1	Regulated output voltage pin. A small (1 μ F) ceramic capacitor is needed from this pin to ground to assure stability. See the <i>Input and Output Capacitor Requirements</i> in the Application Information section for more details.
NC	2	Not connected
EN	4	Driving the enable pin (EN) over 1.2 V turns ON the regulator. Driving this pin below 0.4 V puts the regulator into shutdown mode, reducing operating current to 18 nA typical.
GND	3, 5	ALL ground pins must be tied to ground for proper operation.
IN	6	Input pin. A small capacitor is needed from this pin to ground to assure stability. Typical input capacitor = 1.0 μ F. Both input and output capacitor grounds should be tied back to the IC ground with no significant impedance between them.
Thermal pad	Thermal pad	It is recommended that the thermal pad on the SON-6 package be connected to ground.

TYPICAL CHARACTERISTICS

$T_J = -40^\circ\text{C}$ to 125°C , $V_{IN} = V_{OUT(TYP)} + 0.5\text{ V}$ or 2.2 V , whichever is greater; $I_{OUT} = 100\ \mu\text{A}$, $V_{EN} = V_{IN}$, $C_{OUT} = 1\ \mu\text{F}$, $C_{IN} = 1\ \mu\text{F}$ (unless otherwise noted)

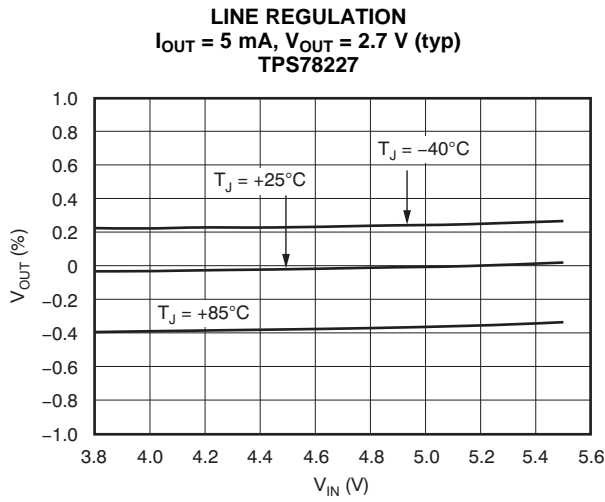

Figure 1.

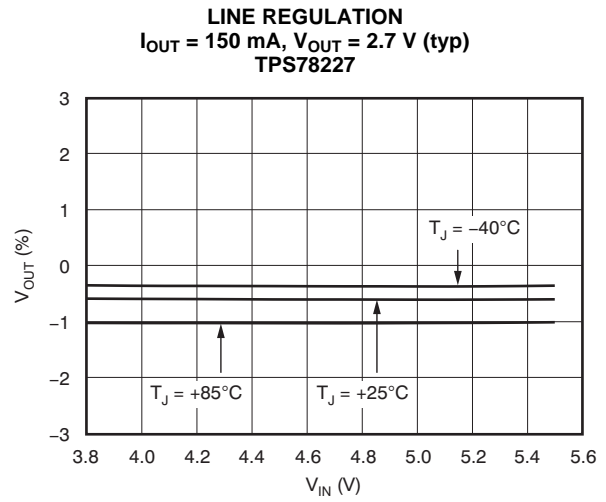

Figure 2.

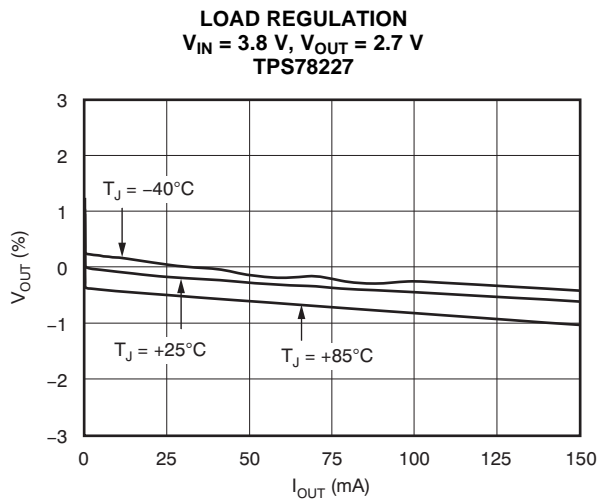

Figure 3.

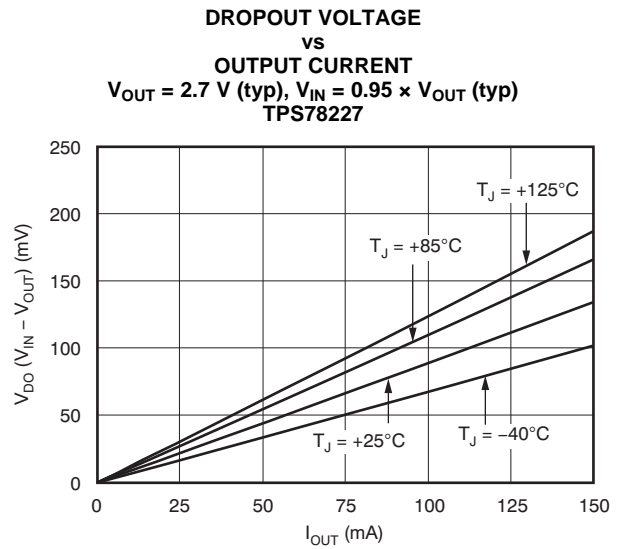

Figure 4.

TYPICAL CHARACTERISTICS (continued)

$T_J = -40^\circ\text{C}$ to 125°C , $V_{IN} = V_{OUT(TYP)} + 0.5\text{ V}$ or 2.2 V , whichever is greater; $I_{OUT} = 100\ \mu\text{A}$, $V_{EN} = V_{IN}$, $C_{OUT} = 1\ \mu\text{F}$, $C_{IN} = 1\ \mu\text{F}$ (unless otherwise noted)

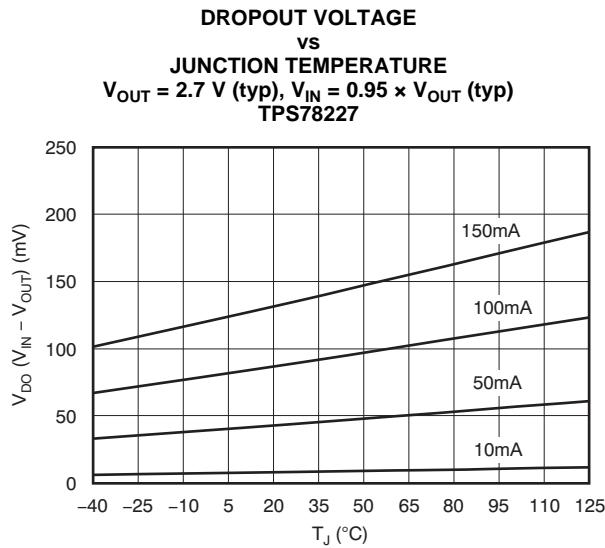

Figure 5.

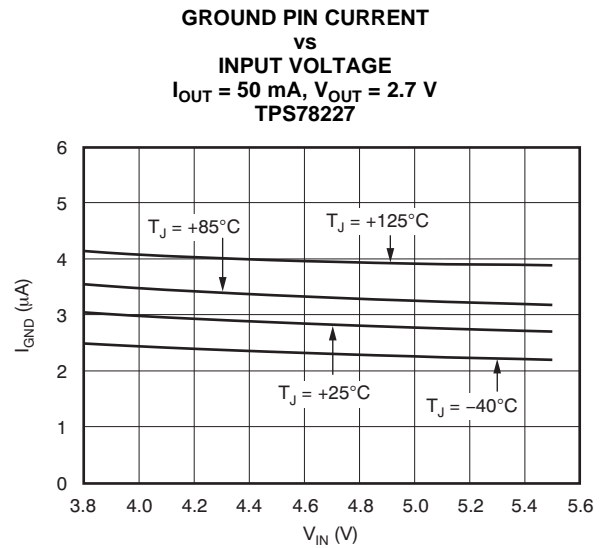

Figure 6.

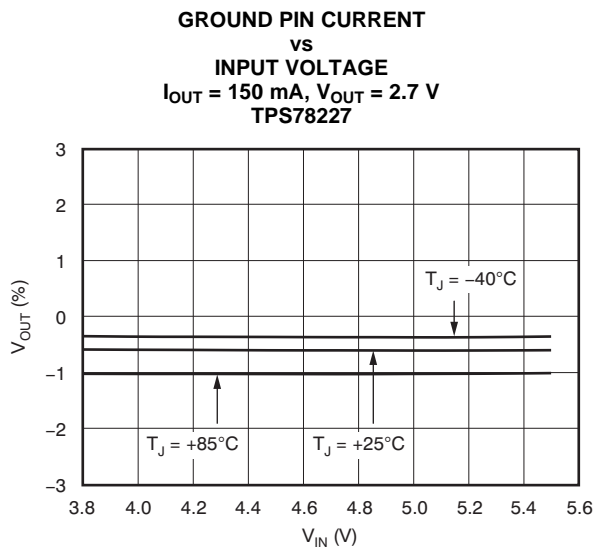

Figure 7.

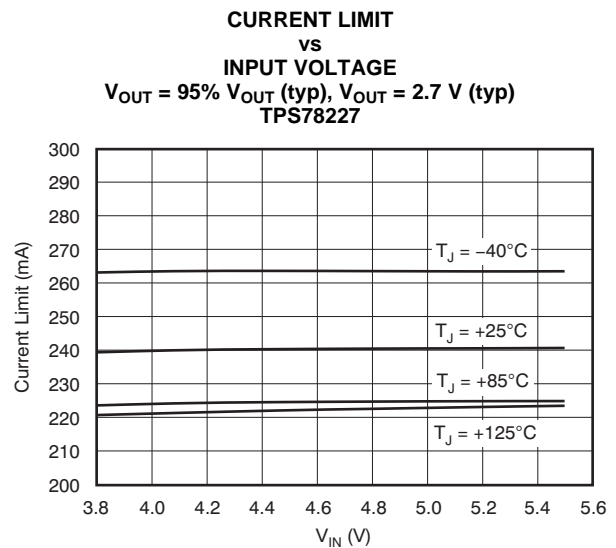

Figure 8.

TYPICAL CHARACTERISTICS (continued)

$T_J = -40^\circ\text{C}$ to 125°C , $V_{IN} = V_{OUT(TYP)} + 0.5\text{ V}$ or 2.2 V , whichever is greater; $I_{OUT} = 100\ \mu\text{A}$, $V_{EN} = V_{IN}$, $C_{OUT} = 1\ \mu\text{F}$, $C_{IN} = 1\ \mu\text{F}$ (unless otherwise noted)

**ENABLE PIN CURRENT
vs
INPUT VOLTAGE**
 $I_{OUT} = 100\ \mu\text{A}$, $V_{OUT} = 2.7\text{ V}$
TPS78227

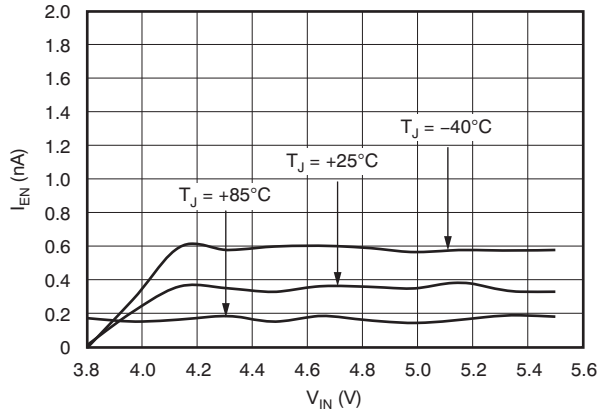

Figure 9.

**ENABLE PIN HYSTERESIS
vs
JUNCTION TEMPERATURE**
 $I_{OUT} = 1\text{ mA}$, TPS78227

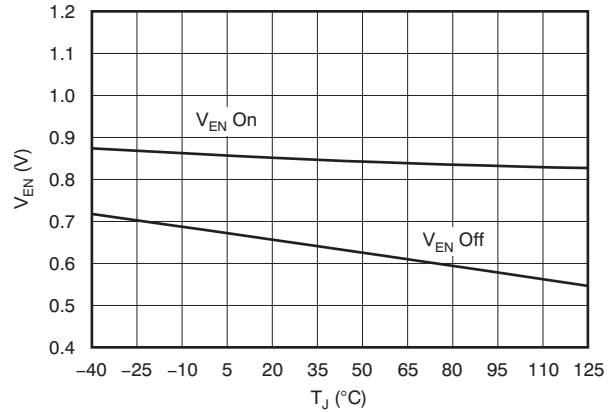

Figure 10.

**% ΔV_{OUT}
vs
JUNCTION TEMPERATURE**
 $V_{IN} = 3.3\text{ V}$, $V_{OUT} = 2.7\text{ V (typ)}$
TPS78227

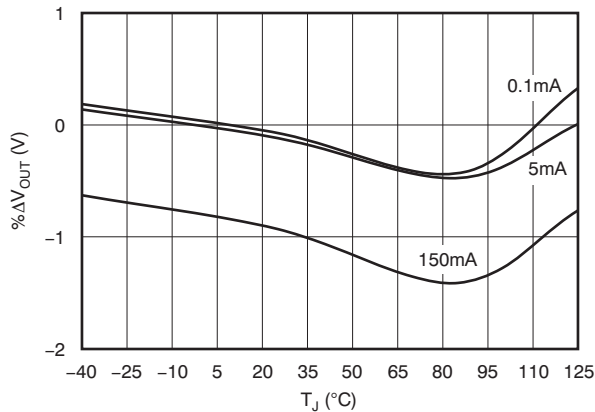

Figure 11.

**% ΔV_{OUT}
vs
JUNCTION TEMPERATURE**
 $V_{IN} = 3.7\text{ V}$, $V_{OUT} = 2.7\text{ V (typ)}$
TPS78227

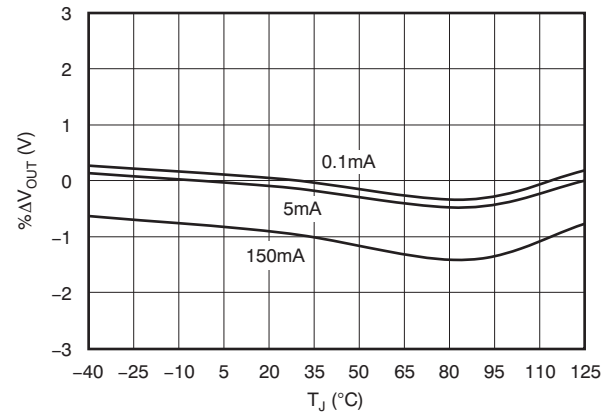

Figure 12.

TYPICAL CHARACTERISTICS (continued)

$T_J = -40^\circ\text{C}$ to 125°C , $V_{IN} = V_{OUT(TYP)} + 0.5\text{ V}$ or 2.2 V , whichever is greater; $I_{OUT} = 100\ \mu\text{A}$, $V_{EN} = V_{IN}$, $C_{OUT} = 1\ \mu\text{F}$, $C_{IN} = 1\ \mu\text{F}$ (unless otherwise noted)

**OUTPUT SPECTRAL NOISE DENSITY
 vs
 FREQUENCY**
 $C_{IN} = 1\ \mu\text{F}$, $C_{OUT} = 2.2\ \mu\text{F}$, $V_{IN} = 3.2\text{ V}$
 TPS78227

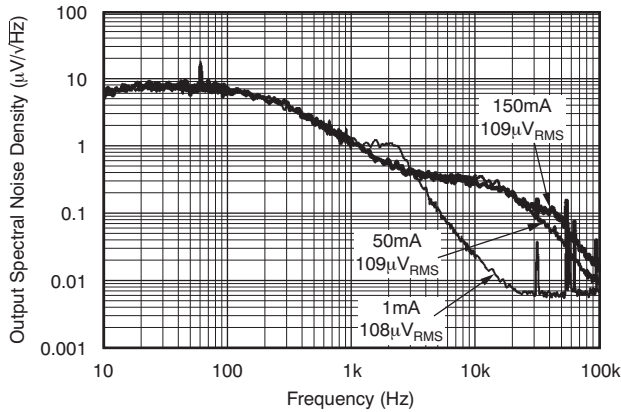

Figure 13.

**RIPPLE REJECTION
 vs
 FREQUENCY**
 $V_{IN} = 4.2\text{ V}$, $V_{OUT} = 2.7\text{ V}$, $C_{OUT} = 2.2\ \mu\text{F}$
 TPS78227

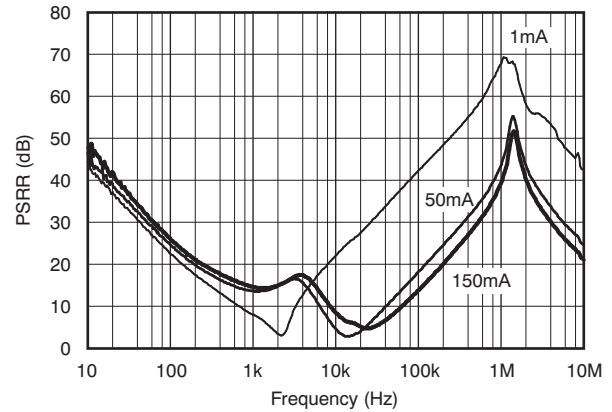

Figure 14.

APPLICATION INFORMATION

APPLICATION EXAMPLES

The TPS782xx family of LDOs is factory-programmable to have a fixed output. Note that during startup or steady-state conditions, it is important that the EN pin voltage never exceed $V_{IN} + 0.3\text{ V}$.

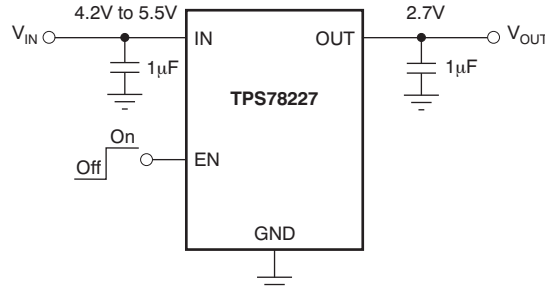

Figure 15. Typical Application Circuit

INPUT AND OUTPUT CAPACITOR REQUIREMENTS

Although an input capacitor is not required for stability, it is good analog design practice to connect a 0.1- μF to 1.0- μF low equivalent series resistance (ESR) capacitor across the input supply near the regulator. This capacitor counteracts reactive input sources and improves transient response, noise rejection, and ripple rejection. A higher-value capacitor may be necessary if large, fast rise-time load transients are anticipated, or if the device is not located near the power source. If source impedance is not sufficiently low, a 0.1- μF input capacitor may be necessary to ensure stability.

The TPS782xx series are designed to be stable with standard ceramic capacitors with values of 1.0 μF or larger at the output. X5R- and X7R-type capacitors are best because they have minimal variation in value and ESR over temperature. Maximum ESR should be less than 1.0 Ω . With tolerance and dc bias effects, the minimum capacitance to ensure stability is 1 μF .

BOARD LAYOUT RECOMMENDATIONS TO IMPROVE PSRR AND NOISE PERFORMANCE

To improve ac performance (such as PSRR, output noise, and transient response), it is recommended that the printed circuit board (PCB) be designed with separate ground planes for V_{IN} and V_{OUT} , with each ground plane connected only at the GND pin of the device. In addition, the ground connection for the output capacitor should connect directly to the GND pin of the device. High ESR capacitors may degrade PSRR.

INTERNAL CURRENT LIMIT

The TPS782xx is internally current-limited to protect the regulator during fault conditions. During current limit, the output sources a fixed amount of current that is largely independent of output voltage. For reliable operation, the device should not be operated in a current limit state for extended periods of time.

The PMOS pass element in the TPS782xx series has a built-in body diode that conducts current when the voltage at OUT exceeds the voltage at IN. This current is not limited, so if extended reverse voltage operation is anticipated, external limiting to 5% of rated output current may be appropriate.

SHUTDOWN

The enable pin (EN) is active high and is compatible with standard and low-voltage CMOS levels. When shutdown capability is not required, EN should be connected to the IN pin, as shown in [Figure 16](#). The TPS782xx series, with internal active output pulldown circuitry, discharges the output to within 5% V_{OUT} with a time (t) shown in [Equation 1](#):

$$t = 3 \left[\frac{10k\Omega \times R_L}{10k\Omega + R_L} \right] \times C_{OUT} \quad (1)$$

Where:

R_L = output load resistance

C_{OUT} = output capacitance

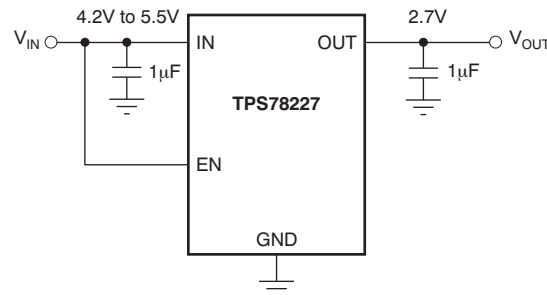

Figure 16. Circuit Showing EN Tied High when Shutdown Capability is Not Required

DROPOUT VOLTAGE

The TPS782xx series use a PMOS pass transistor to achieve low dropout. When $(V_{IN} - V_{OUT})$ is less than the dropout voltage (V_{DO}), the PMOS pass device is in the linear region of operation and the input-to-output resistance is the $R_{DS(ON)}$ of the PMOS pass element. V_{DO} approximately scales with output current because the PMOS device behaves like a resistor in dropout. As with any linear regulator, PSRR and transient response are degraded as $(V_{IN} - V_{OUT})$ approaches dropout. This effect is shown in the Typical Characteristics section. See the application report *Understanding LDO Dropout* ([SLVA207](#)) available for download from [www.ti.com](#).

TRANSIENT RESPONSE

As with any regulator, increasing the size of the output capacitor reduces over/undershoot magnitude but increases duration of the transient response.

ACTIVE V_{OUT} PULL-DOWN

In the TPS782xx series, the active pulldown discharges V_{OUT} when the device is off. However, the input voltage must be greater than 2.2 V for the active pulldown to work.

MINIMUM LOAD

The TPS782xx series are stable with no output load. Traditional PMOS LDO regulators suffer from lower loop gain at very light output loads. The TPS782xx employs an innovative, low-current circuit under very light or no-load conditions, resulting in improved output voltage regulation performance down to zero output current.

THERMAL INFORMATION

THERMAL PROTECTION

Thermal protection disables the device output when the junction temperature rises to approximately 160°C, allowing the device to cool. Once the junction temperature cools to approximately 140°C, the output circuitry is enabled. Depending on power dissipation, thermal resistance, and ambient temperature, the thermal protection circuit may cycle on and off again. This cycling limits the dissipation of the regulator, protecting it from damage as a result of overheating.

Any tendency to activate the thermal protection circuit indicates excessive power dissipation or an inadequate heatsink. For reliable operation, junction temperature should be limited to 125°C maximum. To estimate the margin of safety in a complete design (including heatsink), increase the ambient temperature until the thermal protection is triggered; use worst-case loads and signal conditions. For good reliability, thermal protection should trigger at least 35°C above the maximum expected ambient condition of your particular application. This configuration produces a worst-case junction temperature of 125°C at the highest expected ambient temperature and worst-case load.

The internal protection circuitry of the TPS782xx series has been designed to protect against overload conditions. However, it is not intended to replace proper heatsinking. Continuously running the TPS782xx series into thermal shutdown degrades device reliability.

POWER DISSIPATION

The ability to remove heat from the die is different for each package type, presenting different considerations in the PCB layout. The PCB area around the device that is free of other components moves the heat from the device to the ambient air. Performance data for JEDEC low- and high-K boards are given in the [Dissipation Ratings](#) table. Using heavier copper increases the effectiveness in removing heat from the device. The addition of plated through-holes to heat-dissipating layers also improves the heatsink effectiveness. Power dissipation depends on input voltage and load conditions. Power dissipation (P_D) is equal to the product of the output current times the voltage drop across the output pass element (V_{IN} to V_{OUT}), as shown in [Equation 2](#):

$$P_D = (V_{IN} - V_{OUT}) \times I_{OUT} \quad (2)$$

PACKAGE MOUNTING

Solder pad footprint recommendations for the TPS782xx series are available from the Texas Instruments web site at www.ti.com through the [TPS782xx series product folders](#).

PACKAGING INFORMATION

Orderable Device	Status ⁽¹⁾	Package Type	Package Drawing	Pins	Package Qty	Eco Plan ⁽²⁾	Lead/Ball Finish	MSL Peak Temp ⁽³⁾
TPS78225QDRVRQ1	ACTIVE	SON	DRV	6	3000	Green (RoHS & no Sb/Br)	CU NIPDAU	Level-1-260C-UNLIM
TPS78227QDRVRQ1	ACTIVE	SON	DRV	6	3000	Green (RoHS & no Sb/Br)	CU NIPDAU	Level-1-260C-UNLIM
TPS78228QDRVRQ1	ACTIVE	SON	DRV	6	3000	Green (RoHS & no Sb/Br)	CU NIPDAU	Level-1-260C-UNLIM
TPS78230QDRVRQ1	ACTIVE	SON	DRV	6	3000	Green (RoHS & no Sb/Br)	CU NIPDAU	Level-1-260C-UNLIM

⁽¹⁾ The marketing status values are defined as follows:

ACTIVE: Product device recommended for new designs.

LIFEBUY: TI has announced that the device will be discontinued, and a lifetime-buy period is in effect.

NRND: Not recommended for new designs. Device is in production to support existing customers, but TI does not recommend using this part in a new design.

PREVIEW: Device has been announced but is not in production. Samples may or may not be available.

OBSOLETE: TI has discontinued the production of the device.

⁽²⁾ Eco Plan - The planned eco-friendly classification: Pb-Free (RoHS), Pb-Free (RoHS Exempt), or Green (RoHS & no Sb/Br) - please check <http://www.ti.com/productcontent> for the latest availability information and additional product content details.

TBD: The Pb-Free/Green conversion plan has not been defined.

Pb-Free (RoHS): TI's terms "Lead-Free" or "Pb-Free" mean semiconductor products that are compatible with the current RoHS requirements for all 6 substances, including the requirement that lead not exceed 0.1% by weight in homogeneous materials. Where designed to be soldered at high temperatures, TI Pb-Free products are suitable for use in specified lead-free processes.

Pb-Free (RoHS Exempt): This component has a RoHS exemption for either 1) lead-based flip-chip solder bumps used between the die and package, or 2) lead-based die adhesive used between the die and leadframe. The component is otherwise considered Pb-Free (RoHS compatible) as defined above.

Green (RoHS & no Sb/Br): TI defines "Green" to mean Pb-Free (RoHS compatible), and free of Bromine (Br) and Antimony (Sb) based flame retardants (Br or Sb do not exceed 0.1% by weight in homogeneous material)

⁽³⁾ MSL, Peak Temp. -- The Moisture Sensitivity Level rating according to the JEDEC industry standard classifications, and peak solder temperature.

Important Information and Disclaimer:The information provided on this page represents TI's knowledge and belief as of the date that it is provided. TI bases its knowledge and belief on information provided by third parties, and makes no representation or warranty as to the accuracy of such information. Efforts are underway to better integrate information from third parties. TI has taken and continues to take reasonable steps to provide representative and accurate information but may not have conducted destructive testing or chemical analysis on incoming materials and chemicals. TI and TI suppliers consider certain information to be proprietary, and thus CAS numbers and other limited information may not be available for release.

In no event shall TI's liability arising out of such information exceed the total purchase price of the TI part(s) at issue in this document sold by TI to Customer on an annual basis.

OTHER QUALIFIED VERSIONS OF TPS78225-Q1, TPS78227-Q1, TPS78228-Q1, TPS78230-Q1 :

- Catalog: [TPS78225](#), [TPS78227](#), [TPS78228](#), [TPS78230](#)

NOTE: Qualified Version Definitions:

- Catalog - TI's standard catalog product

TAPE AND REEL INFORMATION



QUADRANT ASSIGNMENTS FOR PIN 1 ORIENTATION IN TAPE



*All dimensions are nominal

Device	Package Type	Package Drawing	Pins	SPQ	Reel Diameter (mm)	Reel Width W1 (mm)	A0 (mm)	B0 (mm)	K0 (mm)	P1 (mm)	W (mm)	Pin1 Quadrant
TPS78227QDRVRQ1	SON	DRV	6	3000	179.0	8.4	2.2	2.2	1.2	4.0	8.0	Q2
TPS78228QDRVRQ1	SON	DRV	6	3000	179.0	8.4	2.2	2.2	1.2	4.0	8.0	Q2
TPS78230QDRVRQ1	SON	DRV	6	3000	179.0	8.4	2.2	2.2	1.2	4.0	8.0	Q2

TAPE AND REEL BOX DIMENSIONS



*All dimensions are nominal

Device	Package Type	Package Drawing	Pins	SPQ	Length (mm)	Width (mm)	Height (mm)
TPS78227QDRVRQ1	SON	DRV	6	3000	203.0	203.0	35.0
TPS78228QDRVRQ1	SON	DRV	6	3000	203.0	203.0	35.0
TPS78230QDRVRQ1	SON	DRV	6	3000	203.0	203.0	35.0

MECHANICAL DATA

DRV (S-PWSON-N6)

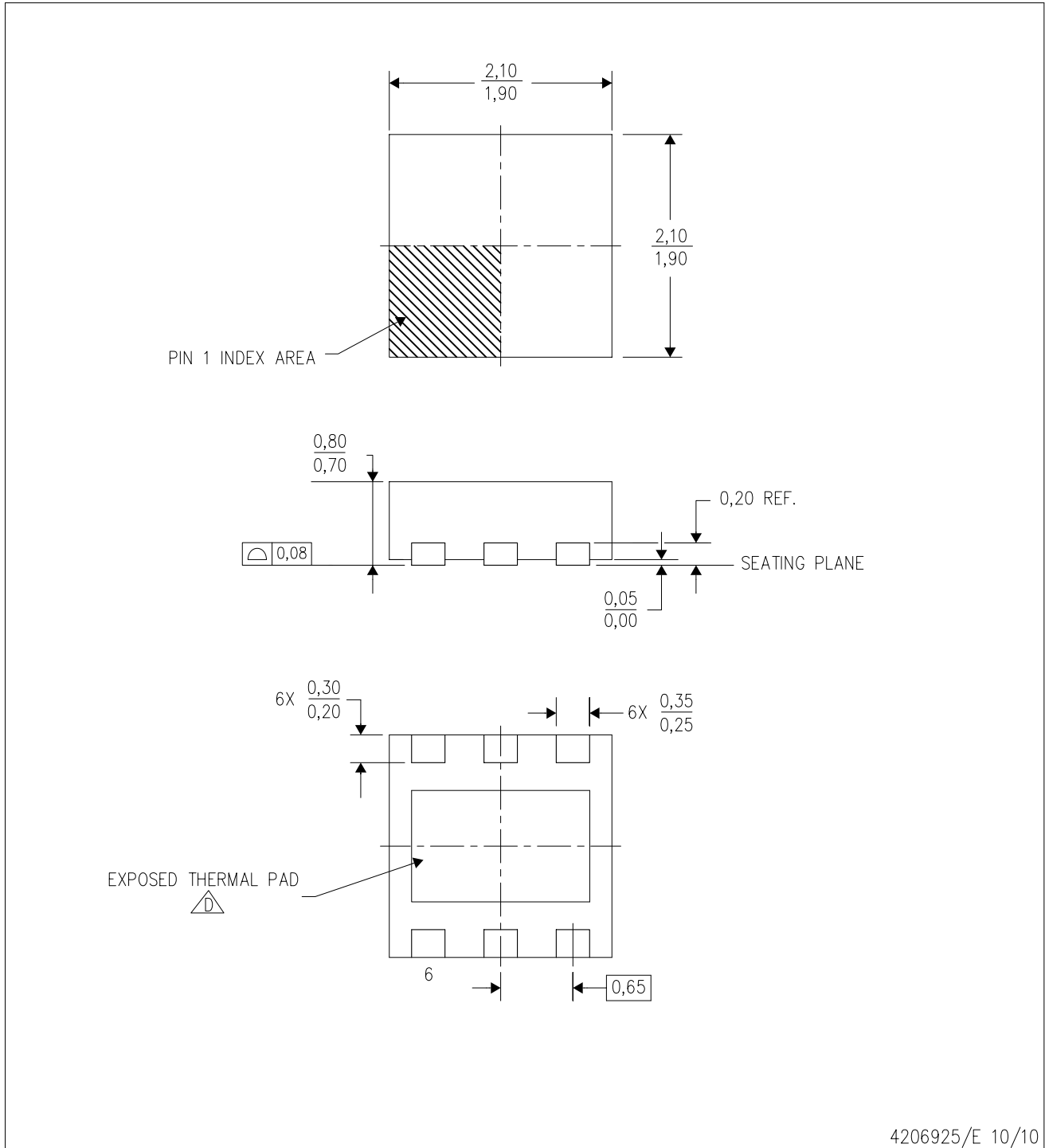
PLASTIC SMALL OUTLINE NO-LEAD



4206925/E 10/10

- NOTES:
- All linear dimensions are in millimeters. Dimensioning and tolerancing per ASME Y14.5M-1994.
 - This drawing is subject to change without notice.
 - Small Outline No-Lead (SON) package configuration.
-  The package thermal pad must be soldered to the board for thermal and mechanical performance. See the Product Data Sheet for details regarding the exposed thermal pad dimensions.

THERMAL PAD MECHANICAL DATA

DRV (S-PWSON-N6)

PLASTIC SMALL OUTLINE NO-LEAD

THERMAL INFORMATION

This package incorporates an exposed thermal pad that is designed to be attached directly to an external heatsink. The thermal pad must be soldered directly to the printed circuit board (PCB). After soldering, the PCB can be used as a heatsink. In addition, through the use of thermal vias, the thermal pad can be attached directly to the appropriate copper plane shown in the electrical schematic for the device, or alternatively, can be attached to a special heatsink structure designed into the PCB. This design optimizes the heat transfer from the integrated circuit (IC).

For information on the Quad Flatpack No-Lead (QFN) package and its advantages, refer to Application Report, QFN/SON PCB Attachment, Texas Instruments Literature No. SLUA271. This document is available at www.ti.com.

The exposed thermal pad dimensions for this package are shown in the following illustration.

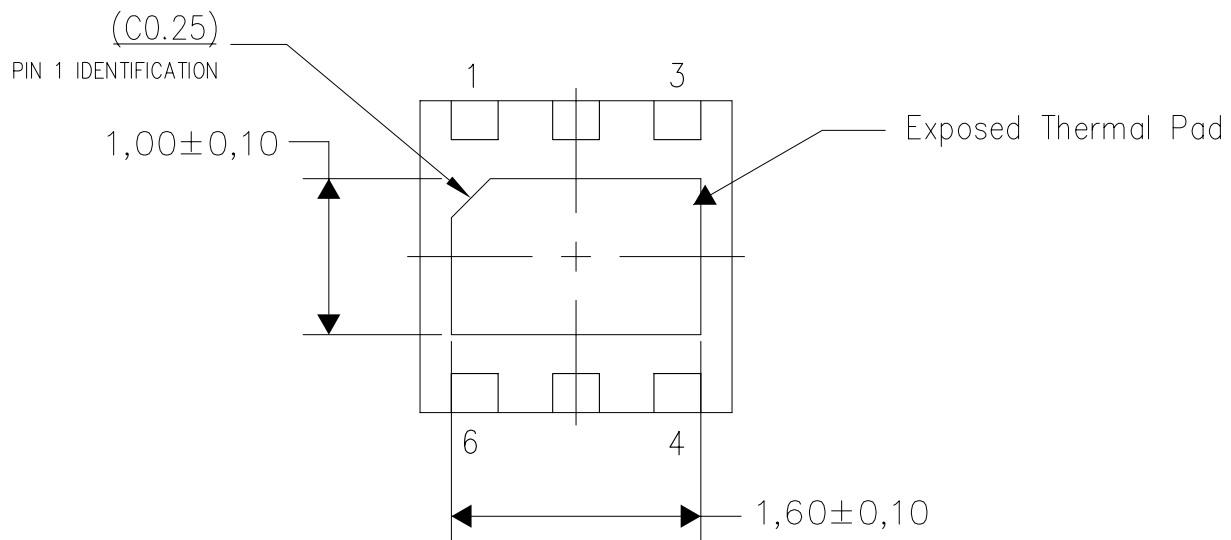

Bottom View

Exposed Thermal Pad Dimensions

4206926-3/L 11/11

NOTE: A. All linear dimensions are in millimeters

DRV (S-PWSON-N6)

PLASTIC SMALL OUTLINE NO-LEAD

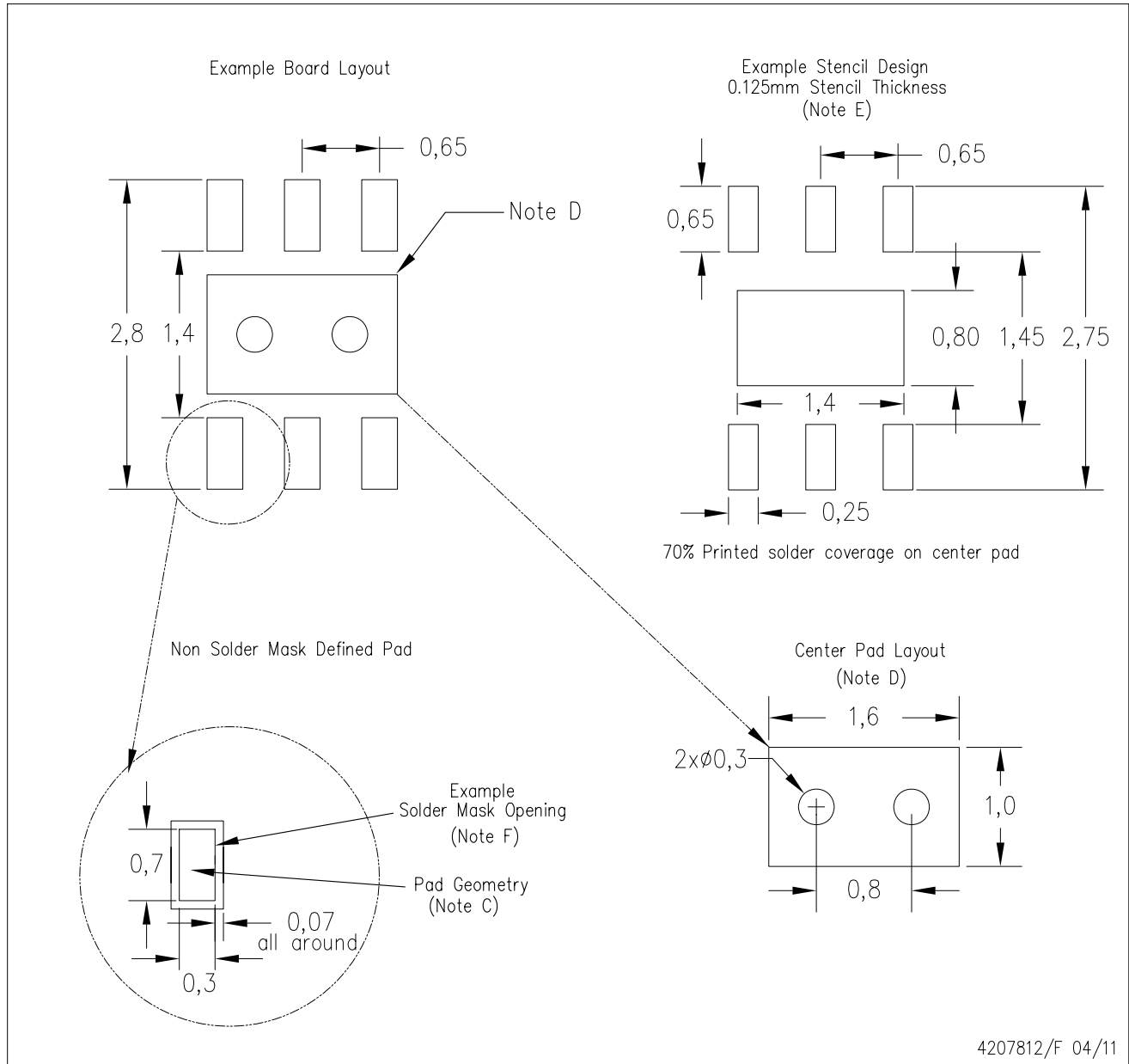

- NOTES:
- A. All linear dimensions are in millimeters.
 - B. This drawing is subject to change without notice.
 - C. Publication IPC-7351 is recommended for alternate designs.
 - D. This package is designed to be soldered to a thermal pad on the board. Refer to Application Note, QFN/SON PCB Attachment, Texas Instruments Literature No. SLUA271, and also the Product Data Sheets for specific thermal information, via requirements, and recommended board layout. These documents are available at www.ti.com <<http://www.ti.com>>.
 - E. Laser cutting apertures with trapezoidal walls and also rounding corners will offer better paste release. Customers should contact their board assembly site for stencil design recommendations. Refer to IPC 7525 for stencil design considerations.
 - F. Customers should contact their board fabrication site for solder mask tolerances.

IMPORTANT NOTICE

Texas Instruments Incorporated and its subsidiaries (TI) reserve the right to make corrections, modifications, enhancements, improvements, and other changes to its products and services at any time and to discontinue any product or service without notice. Customers should obtain the latest relevant information before placing orders and should verify that such information is current and complete. All products are sold subject to TI's terms and conditions of sale supplied at the time of order acknowledgment.

TI warrants performance of its hardware products to the specifications applicable at the time of sale in accordance with TI's standard warranty. Testing and other quality control techniques are used to the extent TI deems necessary to support this warranty. Except where mandated by government requirements, testing of all parameters of each product is not necessarily performed.

TI assumes no liability for applications assistance or customer product design. Customers are responsible for their products and applications using TI components. To minimize the risks associated with customer products and applications, customers should provide adequate design and operating safeguards.

TI does not warrant or represent that any license, either express or implied, is granted under any TI patent right, copyright, mask work right, or other TI intellectual property right relating to any combination, machine, or process in which TI products or services are used. Information published by TI regarding third-party products or services does not constitute a license from TI to use such products or services or a warranty or endorsement thereof. Use of such information may require a license from a third party under the patents or other intellectual property of the third party, or a license from TI under the patents or other intellectual property of TI.

Reproduction of TI information in TI data books or data sheets is permissible only if reproduction is without alteration and is accompanied by all associated warranties, conditions, limitations, and notices. Reproduction of this information with alteration is an unfair and deceptive business practice. TI is not responsible or liable for such altered documentation. Information of third parties may be subject to additional restrictions.

Resale of TI products or services with statements different from or beyond the parameters stated by TI for that product or service voids all express and any implied warranties for the associated TI product or service and is an unfair and deceptive business practice. TI is not responsible or liable for any such statements.

TI products are not authorized for use in safety-critical applications (such as life support) where a failure of the TI product would reasonably be expected to cause severe personal injury or death, unless officers of the parties have executed an agreement specifically governing such use. Buyers represent that they have all necessary expertise in the safety and regulatory ramifications of their applications, and acknowledge and agree that they are solely responsible for all legal, regulatory and safety-related requirements concerning their products and any use of TI products in such safety-critical applications, notwithstanding any applications-related information or support that may be provided by TI. Further, Buyers must fully indemnify TI and its representatives against any damages arising out of the use of TI products in such safety-critical applications.

TI products are neither designed nor intended for use in military/aerospace applications or environments unless the TI products are specifically designated by TI as military-grade or "enhanced plastic." Only products designated by TI as military-grade meet military specifications. Buyers acknowledge and agree that any such use of TI products which TI has not designated as military-grade is solely at the Buyer's risk, and that they are solely responsible for compliance with all legal and regulatory requirements in connection with such use.

TI products are neither designed nor intended for use in automotive applications or environments unless the specific TI products are designated by TI as compliant with ISO/TS 16949 requirements. Buyers acknowledge and agree that, if they use any non-designated products in automotive applications, TI will not be responsible for any failure to meet such requirements.

Following are URLs where you can obtain information on other Texas Instruments products and application solutions:

Products

Audio	www.ti.com/audio
Amplifiers	amplifier.ti.com
Data Converters	dataconverter.ti.com
DLP® Products	www.dlp.com
DSP	dsp.ti.com
Clocks and Timers	www.ti.com/clocks
Interface	interface.ti.com
Logic	logic.ti.com
Power Mgmt	power.ti.com
Microcontrollers	microcontroller.ti.com
RFID	www.ti-rfid.com
OMAP Mobile Processors	www.ti.com/omap
Wireless Connectivity	www.ti.com/wirelessconnectivity

Applications

Automotive and Transportation	www.ti.com/automotive
Communications and Telecom	www.ti.com/communications
Computers and Peripherals	www.ti.com/computers
Consumer Electronics	www.ti.com/consumer-apps
Energy and Lighting	www.ti.com/energy
Industrial	www.ti.com/industrial
Medical	www.ti.com/medical
Security	www.ti.com/security
Space, Avionics and Defense	www.ti.com/space-avionics-defense
Video and Imaging	www.ti.com/video

TI E2E Community Home Page

e2e.ti.com

Mailing Address: Texas Instruments, Post Office Box 655303, Dallas, Texas 75265
Copyright © 2012, Texas Instruments Incorporated