

Low Noise, High-Bandwidth PSRR Low-Dropout 150-mA Linear Regulator

Check for Samples: [TPS71750-Q1](#) , [TPS71709-Q1](#) , [TPS71745-Q1](#)

FEATURES

- Qualified for Automotive Applications
- AEC-Q100 Qualified with the Following Results:
 - Device Temperature Grade 1: -40°C to 125°C Ambient Operating Temperature Range
 - Device HBM ESD Classification Level H2
 - Device HBM ESD Classification Level C4B
- 150-mA Low-Dropout Regulator with Enable
- Low I_Q : 45 μA (typical)
- Available in Multiple Output Versions:
 - Fixed Output with Voltages from 0.9 V to 5 V Using Innovative Factory EEPROM Programming
 - Adjustable Output Voltage from 0.9 V to 6.2 V
- Ultra-High PSRR:
 - 70 dB at 1 kHz, 67 dB at 100 kHz and 45 dB at 1 MHz
- Low Noise: 30- μV typical (100 Hz to 100 kHz)
- Stable with a 1- μF Ceramic Capacitor
- Excellent Load/Line Transient Response
- 3% Overall Accuracy (Over Load, Line, or Temp)
- Overcurrent and Overtemperature Protection
- Very Low Dropout: 170-mV Typical at 150 mA
- Small SC70-5, 2-mm x 2-mm SON-6, and 1.5-mm x 1.5-mm SON-6 Packages

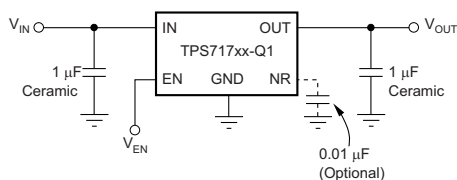

Typical Application Circuit for Fixed Voltage Versions

APPLICATIONS

- Wireless LAN, *Bluetooth*[®]

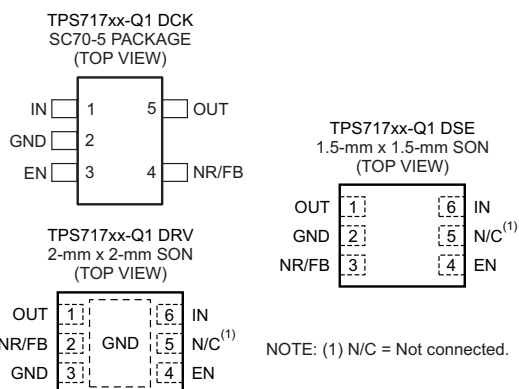

DESCRIPTION

The TPS717xx-Q1 family of low-dropout (LDO), low-power linear regulators offers very high power supply rejection (PSRR) while maintaining very low 45- μA ground current in an ultra-small, five-pin SC70 package. The family uses an advanced BiCMOS process and a PMOSFET pass device to achieve fast start-up, very low noise, excellent transient response, and excellent PSRR performance. The TPS717xx-Q1 is stable with a 1- μF ceramic output capacitor, and uses a precision voltage reference and feedback loop to achieve a worst-case accuracy of 3% over all load, line, process, and temperature variations. It is fully specified from $T_A = -40^{\circ}\text{C}$ to 125°C and is offered in a small SC70-5 package, a 2-mm x 2-mm SON-6 package with a thermal pad, and a 1.5-mm x 1.5-mm SON package, which are ideal for small form factor portable equipment such as wireless handsets and PDAs.

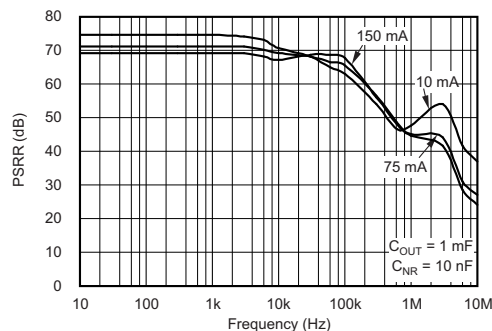

Please be aware that an important notice concerning availability, standard warranty, and use in critical applications of Texas Instruments semiconductor products and disclaimers thereto appears at the end of this data sheet.

Bluetooth is a registered trademark of Bluetooth SIG, Inc.
All other trademarks are the property of their respective owners.



This integrated circuit can be damaged by ESD. Texas Instruments recommends that all integrated circuits be handled with appropriate precautions. Failure to observe proper handling and installation procedures can cause damage.

ESD damage can range from subtle performance degradation to complete device failure. Precision integrated circuits may be more susceptible to damage because very small parametric changes could cause the device not to meet its published specifications.

ABSOLUTE MAXIMUM RATINGS⁽¹⁾

Over operating temperature range (unless otherwise noted). All voltages are with respect to GND.

PARAMETER	VALUE		UNIT
	MIN	MAX	
Input voltage range, V_{IN}	-0.3	7	V
Feedback input voltage range, V_{FB} , V_{NR}	-0.3	3.6	V
Enable voltage range, V_{EN}	-0.3	$V_{IN} + 0.3 V^{(2)}$	V
Output voltage range, V_{OUT}	-0.3	7	V
Maximum output current, I_{OUT}	Internally limited		
Continuous total power dissipation, P_{DISS}	See THERMAL INFORMATION Table		
Ambient temperature range, T_A	-40	125	°C
Junction temperature range, T_J	-55	150	°C
Storage junction temperature range, T_{STG}	-55	150	°C
ESD Ratings	Human body model (HBM) AEC-Q100 Classification Level H2		2 kV
	Charged-device model (CDM) AEC-Q100 Classification Level C4B		750 V

- (1) Stresses above these ratings may cause permanent damage. Exposure to absolute maximum conditions for extended periods may degrade device reliability. These are stress ratings only, and functional operation of the device at these or any other conditions beyond those specified is not implied.
- (2) V_{EN} absolute maximum rating is $V_{IN} + 0.3 V$ or 7 V, whichever is greater.

THERMAL INFORMATION

THERMAL METRIC ⁽¹⁾	TPS717xx-Q1			UNIT
	DCK (5 PINS)	DRV (6 PINS)	DSE (6 PINS)	
θ_{JA} Junction-to-ambient thermal resistance	279.2	71.1	190.5	°C/W
θ_{JcTop} Junction-to-case (top) thermal resistance	57.5	96.5	94.9	
θ_{JB} Junction-to-board thermal resistance	74.1	40.5	149.3	
ψ_{JT} Junction-to-top characterization parameter	0.8	2.7	6.4	
ψ_{JB} Junction-to-board characterization parameter	73.1	40.9	152.8	
θ_{JcBot} Junction-to-case (bottom) thermal resistance	n/a	10.7	n/a	

- (1) For more information about traditional and new thermal metrics, see the *IC Package Thermal Metrics* application report, [SPRA953](#).

ELECTRICAL CHARACTERISTICS

Over operating temperature range ($T_A = -40^{\circ}\text{C}$ to 125°C), $V_{IN} = V_{OUT(TYP)} + 0.5\text{ V}$ or 2.5 V , whichever is greater;
 $I_{OUT} = 0.5\text{ mA}$, $V_{EN} = V_{IN}$, $C_{OUT} = 1\text{ }\mu\text{F}$, $C_{NR} = 0.01\text{ }\mu\text{F}$, unless otherwise noted. For TPS71701-Q1, $V_{OUT} = 2.8\text{ V}$.
 Typical values are at $T_A = 25^{\circ}\text{C}$.

PARAMETER		TEST CONDITIONS	MIN	TYP	MAX	UNIT
V_{IN}	Input voltage range ⁽¹⁾		2.5		6.5	V
V_{FB}	Internal reference (TPS71701-Q1)		0.790	0.800	0.810	V
V_{OUT}	Output voltage range (TPS717xx-Q1)		0.9		5	V
	Output voltage range (TPS71701-Q1)		0.9	$6.5 - V_{DO}$		V
V_{OUT}	Output accuracy	Nominal $T_A = 25^{\circ}\text{C}$		± 2.5		mV
	Output accuracy ($V_{OUT} < 1\text{ V}$)	Over V_{IN} , I_{OUT} , Temp ⁽²⁾	$V_{OUT} + 0.5\text{ V} \leq V_{IN} \leq 6.5\text{ V}$ $0\text{ mA} \leq I_{OUT} \leq 150\text{ mA}$		30	mV
	Output accuracy ($V_{OUT} \geq 1\text{ V}$)	Over V_{IN} , I_{OUT} , Temp ⁽²⁾	$V_{OUT} + 0.5\text{ V} \leq V_{IN} \leq 6.5\text{ V}$ $0\text{ mA} \leq I_{OUT} \leq 150\text{ mA}$	-3		3
$\Delta V_{OUT}/\Delta V_{IN}$	Line regulation ⁽¹⁾	$V_{OUT(NOM)} + 0.5\text{ V} \leq V_{IN} \leq 6.5\text{ V}$, $I_{OUT} = 5\text{ mA}$		125		$\mu\text{V/V}$
$\Delta V_{OUT}/\Delta I_{OUT}$	Load regulation	$0\text{ mA} \leq I_{OUT} \leq 150\text{ mA}$		120		$\mu\text{V/mA}$
V_{DO}	Dropout voltage ⁽³⁾ ($V_{IN} = V_{OUT(NOM)} - 0.1\text{ V}$)	$I_{OUT} = 150\text{ mA}$		170	300	mV
I_{CL} (Fixed)	Output current limit (fixed output)	$V_{OUT} = 0.9 \times V_{OUT(NOM)}$	200	325	575	mA
I_{CL} (Adjustable)	Output current limit (TPS71701-Q1)	$V_{OUT} = 0.9 \times V_{OUT(NOM)}$	200	325	575	mA
I_{GND}	Ground pin current	$I_{OUT} = 0.1\text{ mA}$		45	80	μA
		$I_{OUT} = 150\text{ mA}$		100		μA
I_{SHDN}	Shutdown current (I_{GND})	$V_{EN} \leq 0.4\text{ V}$, $2.5\text{ V} \leq V_{IN} < 4.5\text{ V}$, $T_A = -40^{\circ}\text{C}$ to 125°C		0.20	1.5	μA
		$V_{EN} \leq 0.4\text{ V}$, $4.5\text{ V} \leq V_{IN} \leq 6.5\text{ V}$, $T_A = -40^{\circ}\text{C}$ to 125°C		0.90		μA
I_{FB}	Feedback pin current (TPS71701-Q1)			0.02	1	μA
PSRR	Power-supply rejection ratio $V_{IN} = 3.8\text{ V}$, $V_{OUT} = 2.8\text{ V}$, $I_{OUT} = 150\text{ mA}$	$f = 100\text{ Hz}$		70		dB
		$f = 1\text{ kHz}$		70		dB
		$f = 10\text{ kHz}$		67		dB
		$f = 100\text{ kHz}$		67		dB
		$f = 1\text{ MHz}$		45		dB
V_N	Output noise voltage BW = 100 Hz to 100 kHz, $V_{IN} = 3.8\text{ V}$, $V_{OUT} = 2.8\text{ V}$, $I_{OUT} = 10\text{ mA}$	$C_{NR} = \text{none}$ (fixed output, TPS71701-Q1)		$95 \times V_{OUT}$		μV_{RMS}
		$C_{NR} = 0.001\text{ }\mu\text{F}$		$25 \times V_{OUT}$		μV_{RMS}
		$C_{NR} = 0.01\text{ }\mu\text{F}$		$12.5 \times V_{OUT}$		μV_{RMS}
		$C_{NR} = 0.1\text{ }\mu\text{F}$		$11.5 \times V_{OUT}$		μV_{RMS}
T_{STR}	Startup time $V_{OUT} = 90\% V_{OUT(NOM)}$, $R_L = 19\text{ }\Omega$, $C_{OUT} = 1\text{ }\mu\text{F}$	$0.9\text{ V} \leq V_{OUT} \leq 1.6\text{ V}$, $C_{NR} = 0.001\text{ }\mu\text{F}$		0.700		ms
		$1.6\text{ V} < V_{OUT} < V_{MAX}$, $C_{NR} = 0.01\text{ }\mu\text{F}$		0.160		ms
$V_{EN(HI)}$	Enable high (enabled)	$V_{IN} \leq 5.5\text{ V}$	1.2		$6.5^{(4)}$	V
		$5.5\text{ V} < V_{IN} \leq 6.5\text{ V}$	1.25		6.5	V
$V_{EN(LO)}$	Enable low (shutdown)		0		0.4	V
$I_{EN(HI)}$	Enable pin current, enabled	$EN = 6.5\text{ V}$		0.02	1	μA
UVLO	Under-voltage lockout	V_{IN} rising	2.41	2.45	2.49	V
	Hysteresis	V_{IN} falling		150		mV
T_{SD}	Thermal shutdown temperature	Shutdown, temperature increasing		160		$^{\circ}\text{C}$
		Reset, temperature decreasing		140		$^{\circ}\text{C}$

(1) Minimum $V_{IN} = V_{OUT} + V_{DO}$ or 2.5 V , whichever is greater.

(2) Does not include external resistor tolerances.

(3) V_{DO} is not measured for devices with $V_{OUT(NOM)} < 2.6\text{ V}$ because minimum $V_{IN} = 2.5\text{ V}$.

(4) Maximum $V_{EN(HI)} = V_{IN} + 0.3$ or 6.5 V , whichever is smaller.

DEVICE INFORMATION

FUNCTIONAL BLOCK DIAGRAMS

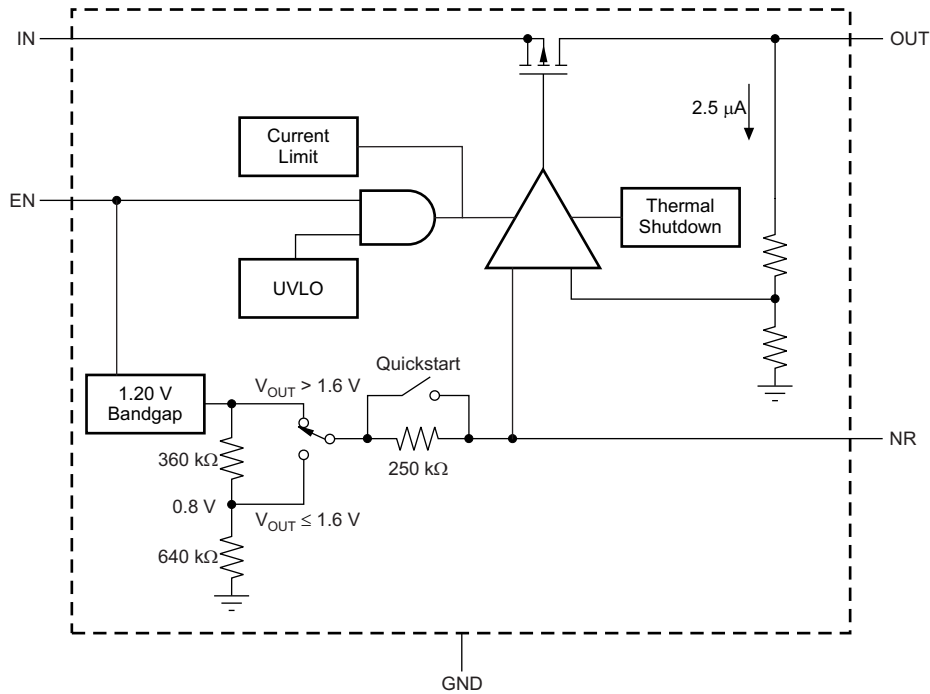

Figure 1. Fixed Voltage Versions

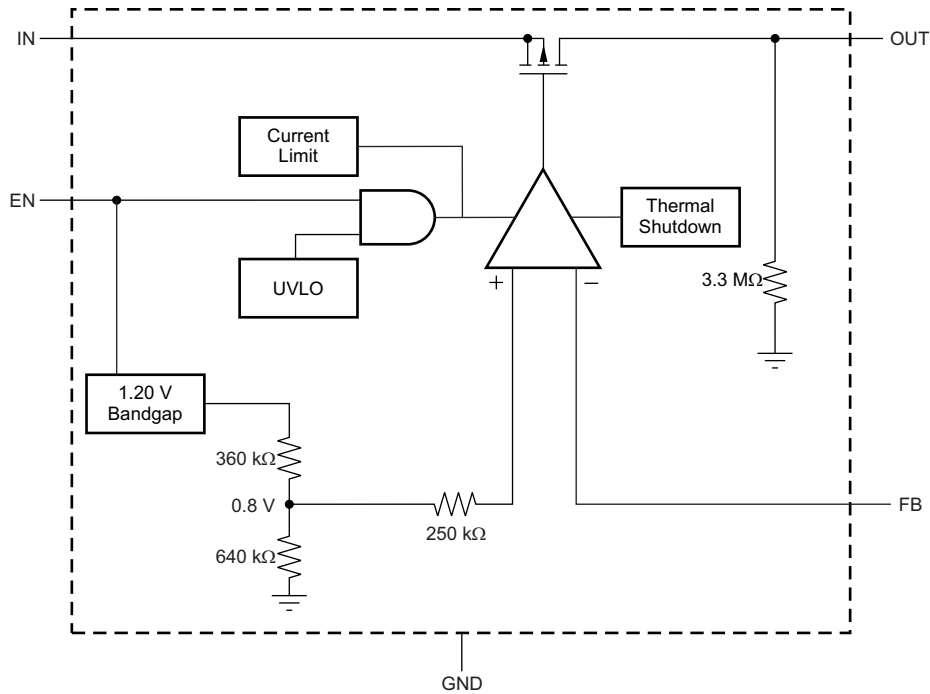
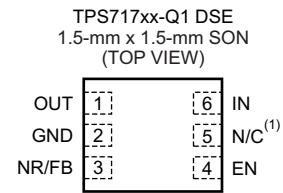
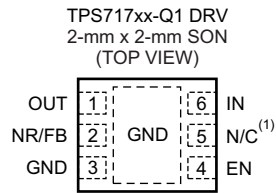
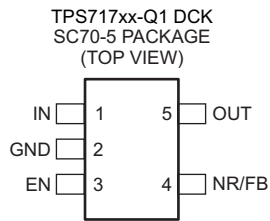

Figure 2. Adjustable Voltage Version

PIN CONFIGURATIONS



NOTE: (1) N/C = Not connected.

Table 1. PIN DESCRIPTIONS

TPS717xx-Q1				DESCRIPTION
NAME	SC70 (DCK)	2 x 2 SON (DRV)	1.5 x 1.5 SON (DSE)	
IN	1	6	6	Input to the device.
GND	2	3	2	Ground.
EN	3	4	4	Driving the enable pin (EN) high turns on the regulator. Driving this pin low puts the regulator into standby mode, thereby reducing operating current.
NR	4	2	3	Fixed voltage versions only. An external capacitor connected to this terminal bypasses noise generated by the internal bandgap, lowering output noise.
FB	4	2	3	Adjustable voltage version only. The voltage at this pin is fed to the error amplifier. A resistor divider from OUT to FB sets the output voltage when in regulation.
OUT	5	1	1	This is the regulated output voltage. A small capacitor is needed from this pin to ground to assure stability; a 1- μ F ceramic capacitor is adequate.
NC	–	5	5	Not connected. This pin can be tied to ground to improve thermal dissipation.

TYPICAL CHARACTERISTICS

Over operating temperature range ($T_A = -40^\circ\text{C}$ to 125°C), $V_{IN} = V_{OUT(TYP)} + 0.5\text{ V}$ or 2.5 V , whichever is greater; $I_{OUT} = 0.5\text{ mA}$, $V_{EN} = V_{IN}$, $C_{OUT} = 1\ \mu\text{F}$, $C_{NR} = 0.01\ \mu\text{F}$, unless otherwise noted. For TPS71701-Q1, $V_{OUT} = 2.8\text{ V}$. Typical values are at $T_A = 25^\circ\text{C}$.

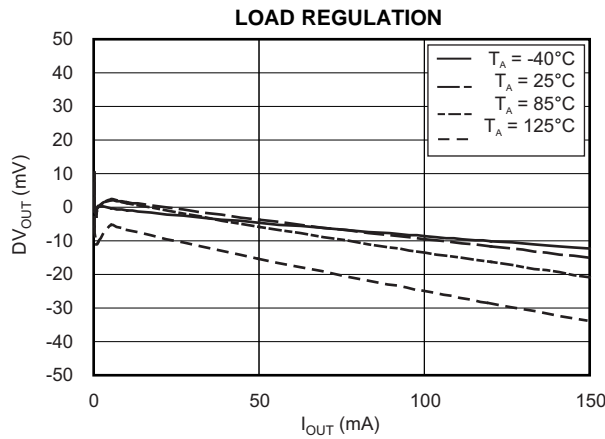

Figure 3.

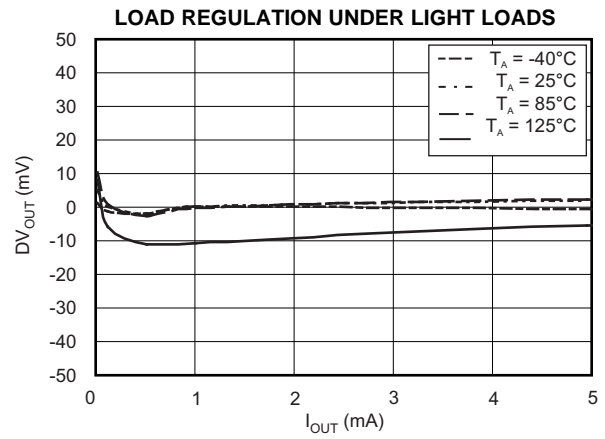

Figure 4.

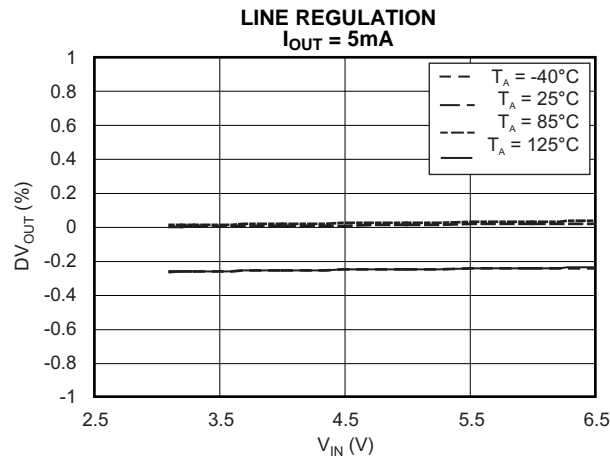

Figure 5.

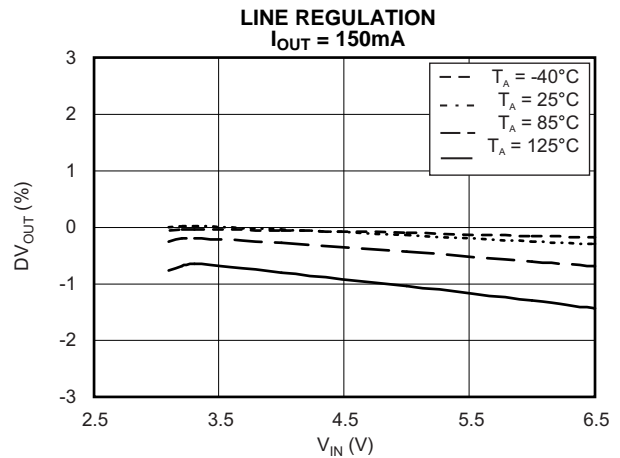

Figure 6.

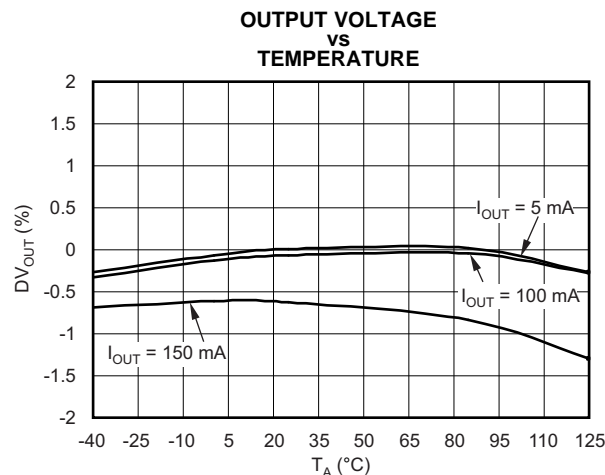

Figure 7.

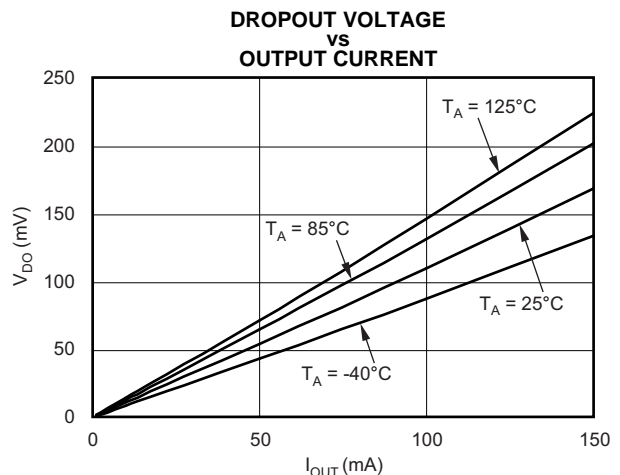

Figure 8.

TYPICAL CHARACTERISTICS (continued)

Over operating temperature range ($T_A = -40^\circ\text{C}$ to 125°C), $V_{IN} = V_{OUT(TYP)} + 0.5\text{ V}$ or 2.5 V , whichever is greater; $I_{OUT} = 0.5\text{ mA}$, $V_{EN} = V_{IN}$, $C_{OUT} = 1\ \mu\text{F}$, $C_{NR} = 0.01\ \mu\text{F}$, unless otherwise noted. For TPS71701-Q1, $V_{OUT} = 2.8\text{ V}$.

Typical values are at $T_A = 25^\circ\text{C}$.

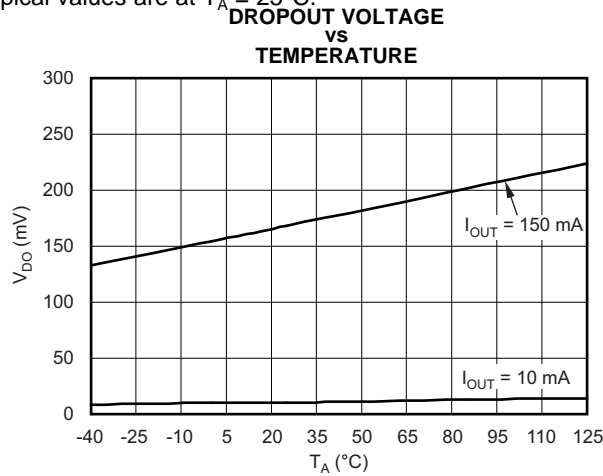

Figure 9.

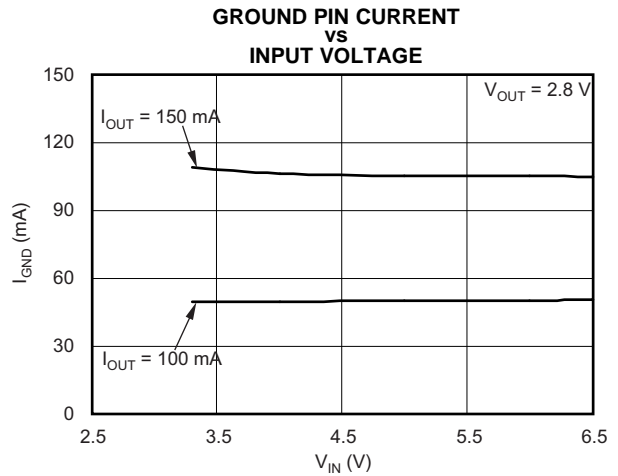

Figure 10.

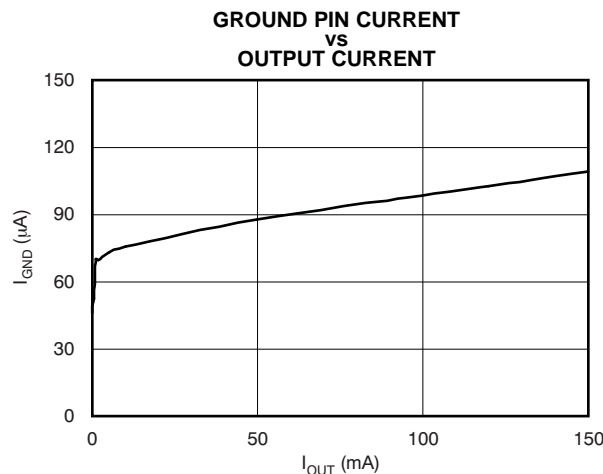

Figure 11.

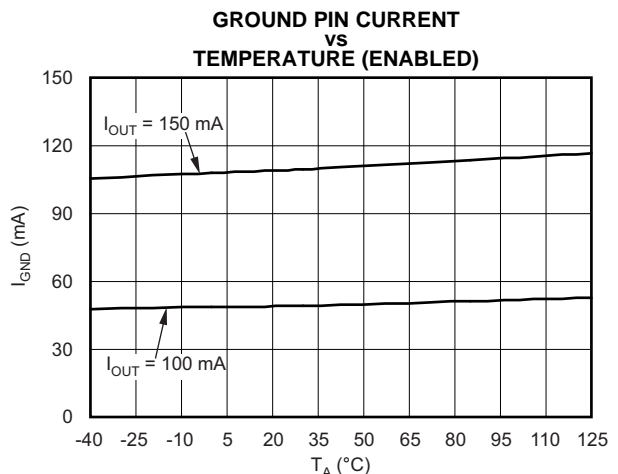

Figure 12.

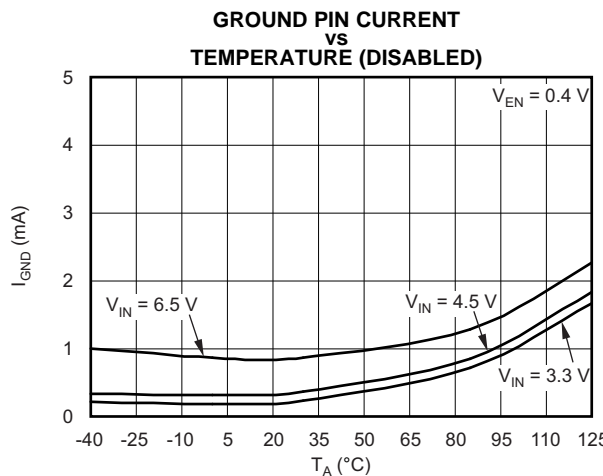

Figure 13.

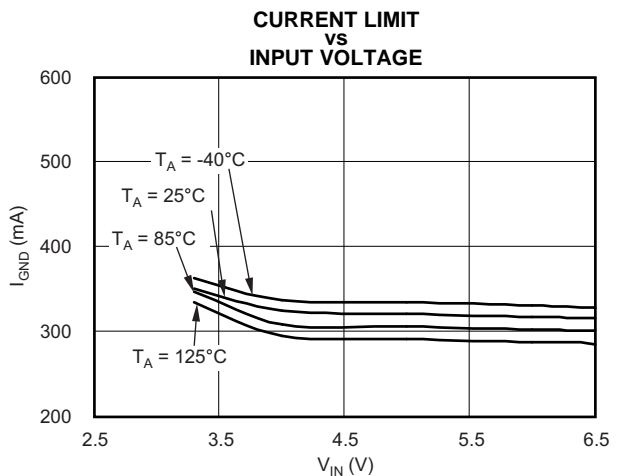

Figure 14.

TYPICAL CHARACTERISTICS (continued)

Over operating temperature range ($T_A = -40^{\circ}\text{C}$ to 125°C), $V_{IN} = V_{OUT(TYP)} + 0.5\text{ V}$ or 2.5 V , whichever is greater; $I_{OUT} = 0.5\text{ mA}$, $V_{EN} = V_{IN}$, $C_{OUT} = 1\text{ }\mu\text{F}$, $C_{NR} = 0.01\text{ }\mu\text{F}$, unless otherwise noted. For TPS71701-Q1, $V_{OUT} = 2.8\text{ V}$.

Typical values are at $T_A = 25^{\circ}\text{C}$.

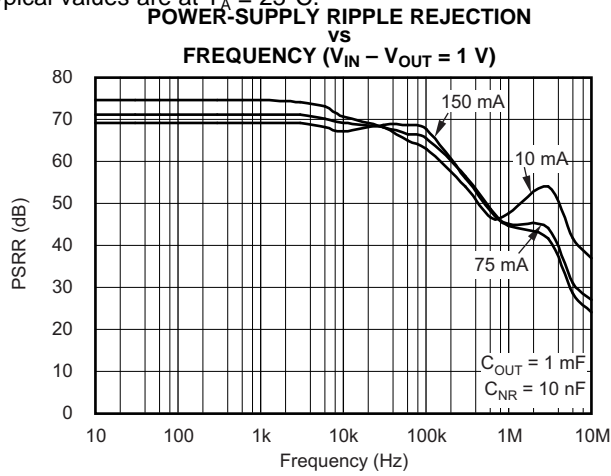

Figure 15.

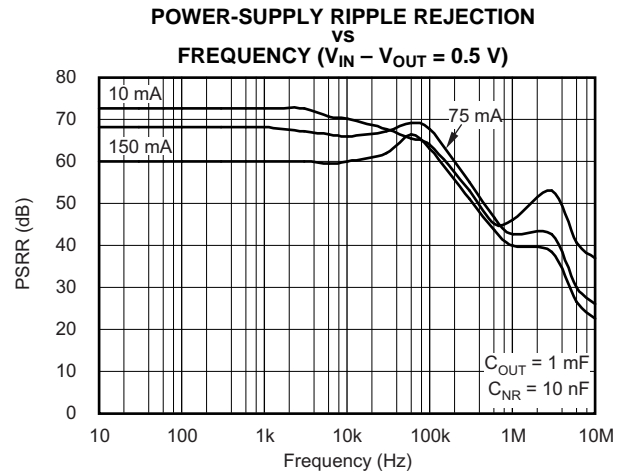

Figure 16.

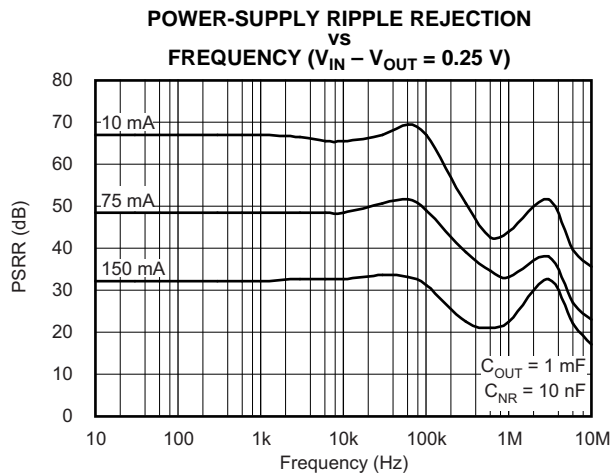

Figure 17.

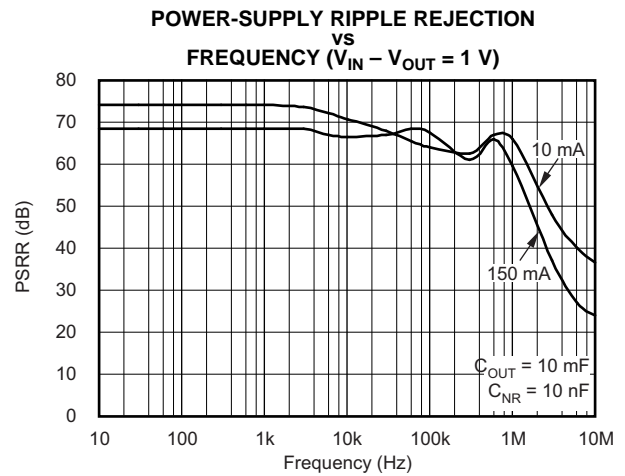

Figure 18.

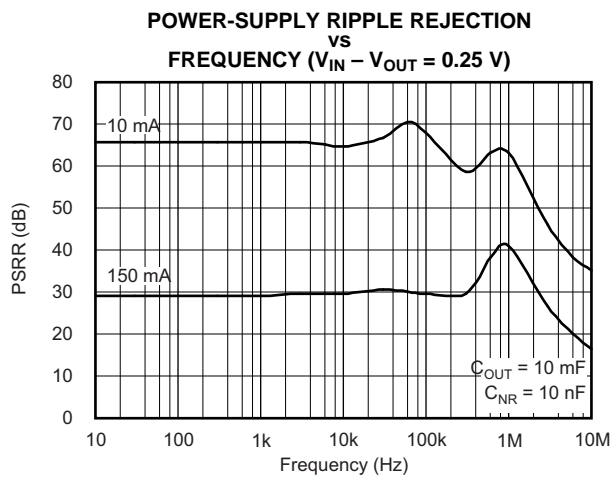

Figure 19.

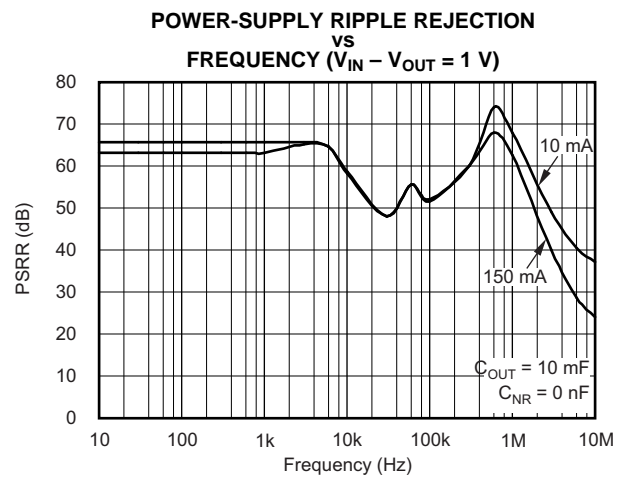

Figure 20.

TYPICAL CHARACTERISTICS (continued)

Over operating temperature range ($T_A = -40^{\circ}\text{C}$ to 125°C), $V_{IN} = V_{OUT(TYP)} + 0.5\text{ V}$ or 2.5 V , whichever is greater; $I_{OUT} = 0.5\text{ mA}$, $V_{EN} = V_{IN}$, $C_{OUT} = 1\text{ }\mu\text{F}$, $C_{NR} = 0.01\text{ }\mu\text{F}$, unless otherwise noted. For TPS71701-Q1, $V_{OUT} = 2.8\text{ V}$.

Typical values are at $T_A = 25^{\circ}\text{C}$.

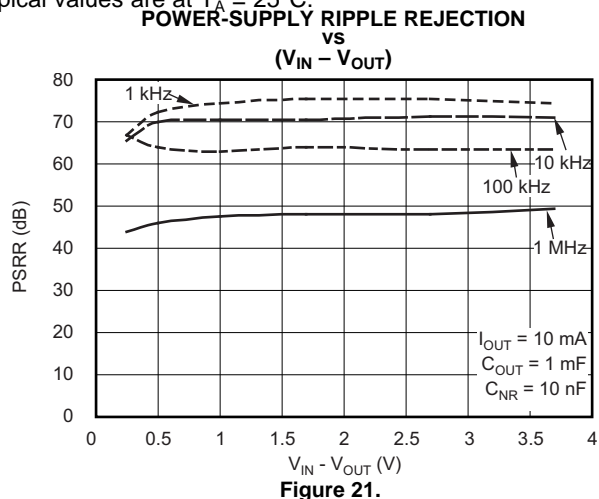

Figure 21.

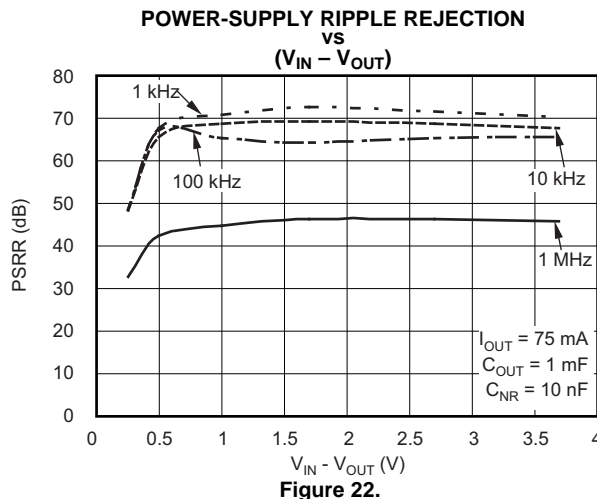

Figure 22.

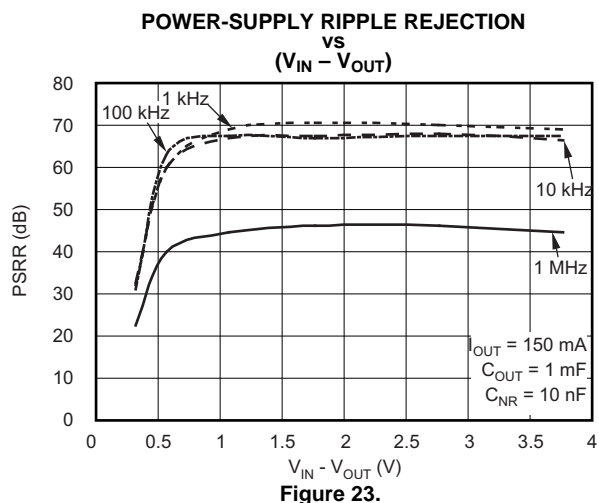

Figure 23.

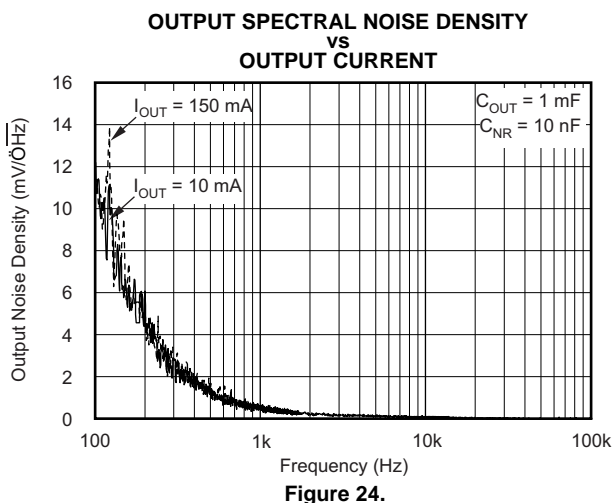

Figure 24.

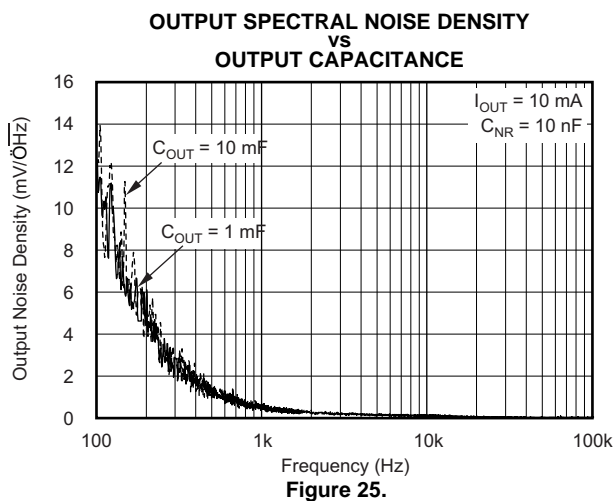

Figure 25.

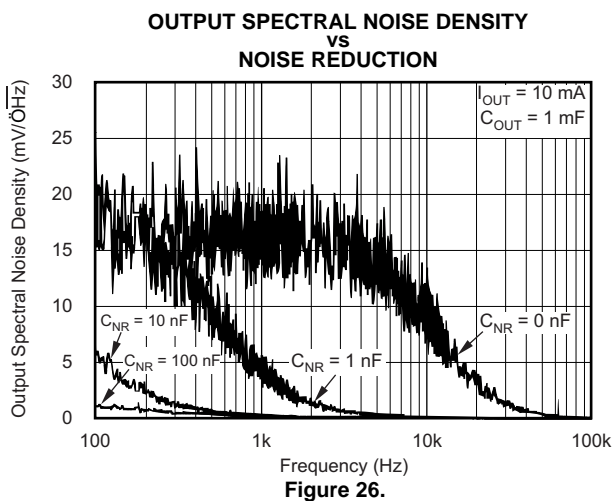
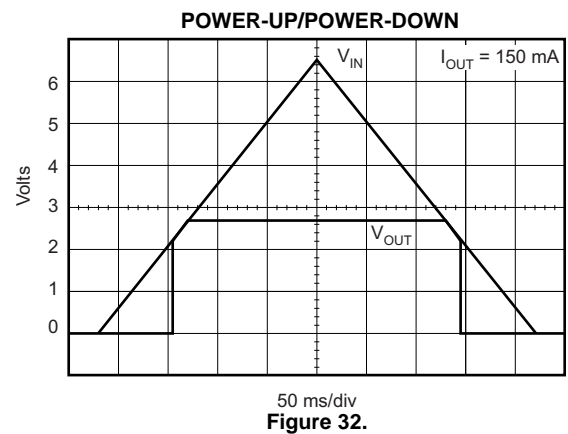
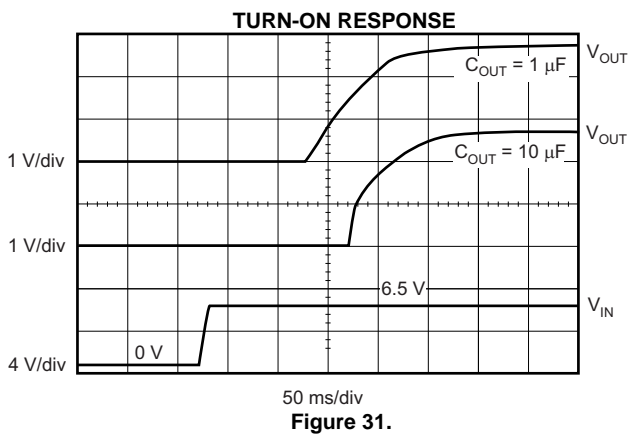
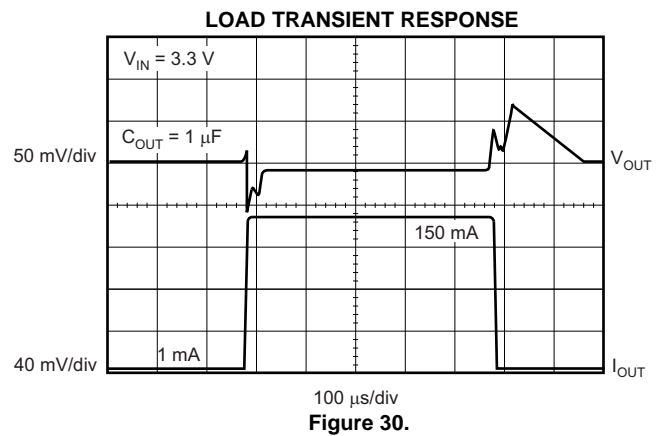
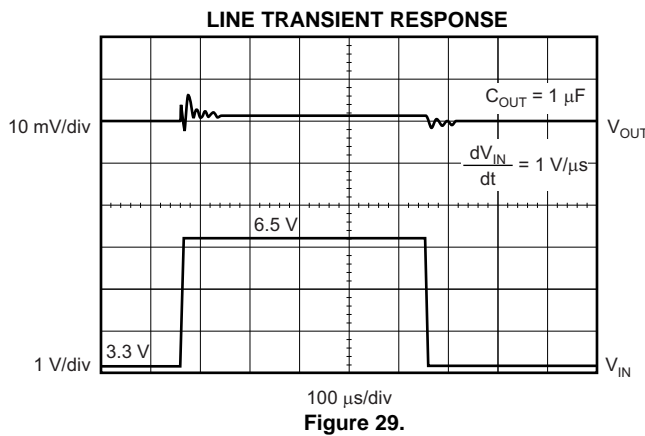
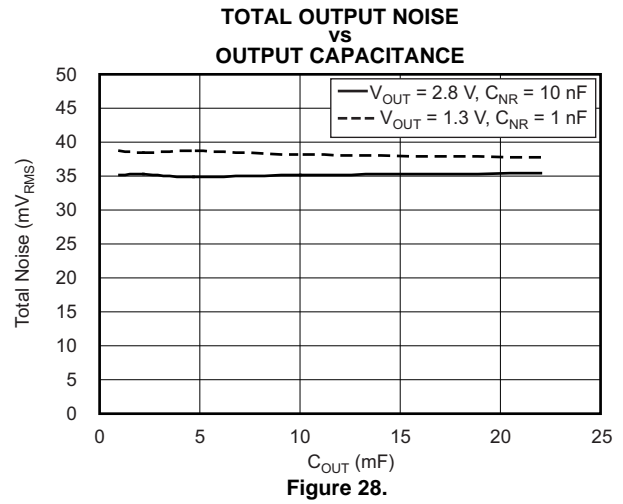
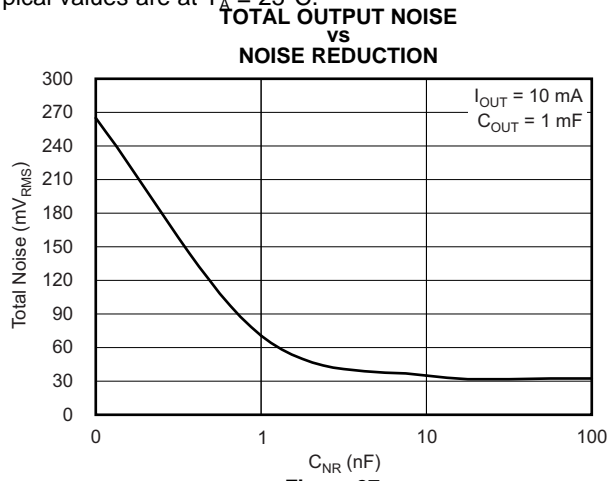

Figure 26.

TYPICAL CHARACTERISTICS (continued)

Over operating temperature range ($T_A = -40^\circ\text{C}$ to 125°C), $V_{IN} = V_{OUT(TYP)} + 0.5\text{ V}$ or 2.5 V , whichever is greater; $I_{OUT} = 0.5\text{ mA}$, $V_{EN} = V_{IN}$, $C_{OUT} = 1\ \mu\text{F}$, $C_{NR} = 0.01\ \mu\text{F}$, unless otherwise noted. For TPS71701-Q1, $V_{OUT} = 2.8\text{ V}$.

Typical values are at $T_A = 25^\circ\text{C}$.



APPLICATION INFORMATION

The TPS717xx-Q1 belongs to a family of new generation LDO regulators that use innovative circuitry to achieve ultra-wide bandwidth and high loop gain, resulting in extremely high PSRR (up to 1 MHz) at very low headroom ($V_{IN} - V_{OUT}$). Fixed voltage versions provide a noise reduction pin to bypass noise generated by the bandgap reference and to improve PSRR while a quick-start circuit fast-charges this capacitor. These features, combined with low noise, enable, low ground pin current, and ultra-small packaging, make this part ideal for portable applications. This family of regulators offers sub-bandgap output voltages, current limit and thermal protection, and is fully specified from -40°C to 125°C .

Figure 33 shows the basic circuit connections for the fixed voltage options. **Figure 34** gives the connections for the adjustable output version (TPS71701-Q1). **Note that the NR pin is not available on the adjustable version.**

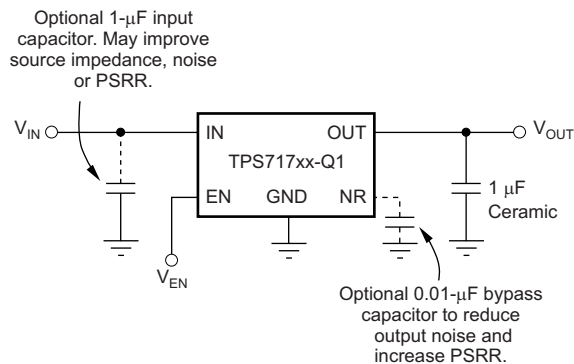

Figure 33. Typical Application Circuit (Fixed Voltage Versions)

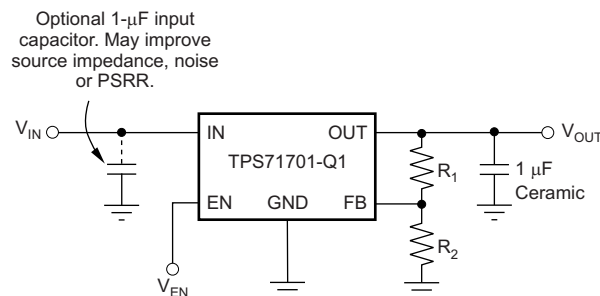

Figure 34. Typical Application Circuit (Adjustable Voltage Version)

For the adjustable version (TPS71701-Q1), the NR pin is replaced with a feedback (FB) pin. The voltage on this pin sets the output voltage and is determined by the values of R_1 and R_2 . The values of R_1 and R_2 can be calculated for any voltage using the formula given in [Equation 1](#):

$$V_{OUT} = \frac{(R_1 + R_2)}{R_2} \times 0.800, R_2 \sim 320\text{k}\Omega \quad (1)$$

The value of R_2 directly impacts the stability of the device and should be chosen at approximately 160 k Ω or 320 k Ω . Sample resistor values for common output voltages are shown in [Table 2](#).

Table 2. Sample 1% Resistor Values for Common Output Voltages

V _{OUT}	R ₁	R ₂
1	80.6 kΩ	324 kΩ
1.2	162 kΩ	324 kΩ
1.5	294 kΩ	332 kΩ
1.8	402 kΩ	324 kΩ
2.5	665 kΩ	316 kΩ
3.3	1.02 MΩ	324 kΩ
5	1.74 MΩ	332 kΩ

Input and Output Capacitor Requirements

Although an input capacitor is not required for stability, it is good analog design practice to connect a 0.1-μF to 1-μF low equivalent series resistance (ESR) capacitor across the input supply near the regulator. This capacitor will counteract reactive input sources and improve transient response, noise rejection, and ripple rejection. A higher-value capacitor may be necessary if large, fast rise-time load transients are anticipated or if the device is located several inches from the power source. If source impedance is not sufficiently low, a 0.1-μF input capacitor may be necessary to ensure stability.

The TPS717xx-Q1 is designed to be stable with standard ceramic capacitors of values 1 μF or larger. The X5R- and X7R-type capacitors are best because they have minimal variation in value and ESR over temperature. Maximum ESR should be < 1 Ω.

The TPS717xx-Q1 implements an innovative internal compensation circuit that does not require a feedback capacitor across R₂ for stability. A feedback capacitor should not be used for this device.

Output Noise

In most LDOs, the bandgap is the dominant noise source. If a noise reduction capacitor (C_{NR}) is used with the TPS717xx-Q1, the bandgap does not contribute significantly to noise. Instead, noise is dominated by the output resistor divider and the error amplifier input. To minimize noise in a given application, use a 0.01-μF (minimum) noise reduction capacitor; for the adjustable version, smaller value resistors in the output resistor divider reduce noise. A parallel combination that gives 2.5 μA of divider current has the same noise performance as a fixed voltage version.

Equation 2 approximates the total noise referred to the feedback point (FB pin) when C_{NR} = 0.01 μF, total noise is approximately given by [Equation 2](#):

$$V_N = 11.5 \frac{\mu V_{RMS}}{V} \times V_{OUT} \quad (2)$$

Board Layout Recommendations to Improve PSRR and Noise Performance

To improve ac performance such as PSRR, output noise, and transient response, it is recommended that the board be designed with separate ground planes for V_{IN} and V_{OUT}, with each ground plane connected only at the GND pin of the device. In addition, the ground connection for the bypass capacitor should connect directly to the GND pin of the device.

Internal Current Limit

The TPS717xx-Q1 internal current limit helps protect the regulator during fault conditions. During current limit, the output sources a fixed amount of current that is largely independent of output voltage. For reliable operation, the device should not be operated in a current limit state for extended periods of time.

The PMOS pass element in the TPS717xx-Q1 has a built-in body diode that conducts current when the voltage at OUT exceeds the voltage at IN. This current is not limited, so if extended reverse voltage operation is anticipated, external limiting may be appropriate.

Shutdown

The enable pin (EN) is active high and is compatible with standard and low voltage, TTL-CMOS levels. When shutdown capability is not required, EN can be connected to IN.

Dropout Voltage

The TPS717xx-Q1 uses a PMOS pass transistor to achieve low dropout. When $(V_{IN} - V_{OUT})$ is less than the dropout voltage (V_{DO}), the PMOS pass device is in its linear region of operation and the input-to-output resistance is the $R_{DS(ON)}$ of the PMOS pass element. V_{DO} will approximately scale with output current because the PMOS device behaves like a resistor in dropout.

As with any linear regulator, PSRR and transient response are degraded as $(V_{IN} - V_{OUT})$ approaches dropout. This effect is shown in [Figure 21](#) through [Figure 23](#) in the [Typical Characteristics](#) section.

Startup

Fixed voltage versions of the TPS717xx-Q1 use a quick-start circuit to fast-charge the noise reduction capacitor, C_{NR} , if present (see [Functional Block Diagrams](#), [Figure 1](#)). This circuit allows the combination of very low output noise and fast start-up times. The NR pin is high impedance, so a low leakage C_{NR} capacitor must be used; most ceramic capacitors are appropriate in this configuration.

Note that for fastest startup, V_{IN} should be applied first, then the enable pin (EN) driven high. If EN is tied to IN, startup will be somewhat slower. Refer to [Figure 31](#) in the [Typical Characteristics](#) section. The quick-start switch is closed for approximately 135 μ s. To ensure that C_{NR} is fully charged during the quick-start time, a 0.01 μ F or smaller capacitor should be used.

For output voltages below 1.6 V, a voltage divider on the bandgap reference voltage is employed to optimize output regulation performance for lower output voltages. This configuration results in an additional resistor in the quick-start path and combined with the noise reduction capacitor (C_{NR}) results in slower start-up times for output voltages below 1.6 V.

[Equation 3](#) approximates the start-up time as a function of C_{NR} for output voltages below 1.6 V:

$$t_{START} = 160\mu s + (540 \frac{\mu s}{nF} \times C_{NR} nF)\mu s \quad (3)$$

Transient Response

As with any regulator, increasing the size of the output capacitor reduces overshoot or undershoot magnitude but increases duration of the transient response.

Under-Voltage Lock-Out (UVLO)

The TPS717xx-Q1 utilizes an under-voltage lock-out circuit to keep the output shut off until internal circuitry is operating properly. The UVLO circuit has a de-glitch feature so that it typically ignores undershoot transients on the input if they are less than 50- μ s duration.

Minimum Load

The TPS717xx-Q1 is stable and well-behaved with no output load. Traditional PMOS LDO regulators suffer from lower loop gain at very light output loads. The TPS717xx-Q1 employs an innovative low-current mode circuit to increase loop gain under very light or no-load conditions, resulting in improved output voltage regulation performance down to zero output current.

THERMAL INFORMATION

Thermal Protection

Thermal protection disables the output when the junction temperature rises to approximately 160°C, allowing the device to cool. When the junction temperature cools to approximately 140°C the output circuitry is again enabled. Depending on power dissipation, thermal resistance, and ambient temperature, the thermal protection circuit may cycle on and off. This cycling limits the dissipation of the regulator, protecting it from damage because of overheating.

Any tendency to activate the thermal protection circuit indicates excessive power dissipation or an inadequate heatsink. For reliable operation, junction temperature should be limited to 125°C maximum. To estimate the margin of safety in a complete design (including heatsink), increase the ambient temperature until the thermal protection is triggered; use worst-case loads and signal conditions. For good reliability, thermal protection should trigger at least 35°C above the maximum expected ambient condition of your particular application. This configuration produces a worst-case junction temperature of 125°C at the highest expected ambient temperature and worst-case load.

The internal protection circuitry of the TPS717xx-Q1 has been designed to protect against overload conditions. It was not intended to replace proper heatsinking. Continuously running the TPS717xx-Q1 into thermal shutdown will degrade device reliability.

Power Dissipation

The ability to remove heat from the die is different for each package type, presenting different considerations in the printed circuit board (PCB) layout. The PCB area around the device that is free of other components moves the heat from the device to the ambient air. Performance data for JEDEC low- and high-K boards are given in the [THERMAL INFORMATION](#) table. Using heavier copper will increase the effectiveness in removing heat from the device. The addition of plated through-holes to heat-dissipating layers also improves the heatsink effectiveness.

Power dissipation depends on input voltage and load conditions. Power dissipation (P_D) is equal to the product of the output current times the voltage drop across the output pass element (V_{IN} to V_{OUT}), as shown in [Equation 4](#):

$$P_D = (V_{IN} - V_{OUT}) \times I_{OUT} \quad (4)$$

Package Mounting

Solder pad footprint recommendations for the TPS717xx-Q1 are available from the Texas Instruments web site at www.ti.com.

REVISION HISTORY

Changes from Original (September 2012) to Revision A	Page
• Changed front page to two-column format.	1
• Added part number TPS71745-Q1.	1
• Changed C3B to C4B in Features.	1
• Removed Ordering Information table.	2
• Added Junction Temperature to Absolute Maximum Ratings table.	2
• Changed C3B to C4B in Absolute Maximum Ratings table.	2
• Changed Application Information section to one-column format.	11

PACKAGING INFORMATION

Orderable Device	Status (1)	Package Type	Package Drawing	Pins	Package Qty	Eco Plan (2)	Lead/Ball Finish	MSL Peak Temp (3)	Op Temp (°C)	Device Marking (4/5)	Samples
TPS71709QDSERQ1	ACTIVE	WSON	DSE	6	3000	Green (RoHS & no Sb/Br)	CU NIPDAU	Level-1-260C-UNLIM	-40 to 125	BD	Samples
TPS71750QDSERQ1	ACTIVE	WSON	DSE	6	3000	Green (RoHS & no Sb/Br)	CU NIPDAU	Level-1-260C-UNLIM		AV	Samples

(1) The marketing status values are defined as follows:

ACTIVE: Product device recommended for new designs.

LIFEBUY: TI has announced that the device will be discontinued, and a lifetime-buy period is in effect.

NRND: Not recommended for new designs. Device is in production to support existing customers, but TI does not recommend using this part in a new design.

PREVIEW: Device has been announced but is not in production. Samples may or may not be available.

OBsolete: TI has discontinued the production of the device.

(2) Eco Plan - The planned eco-friendly classification: Pb-Free (RoHS), Pb-Free (RoHS Exempt), or Green (RoHS & no Sb/Br) - please check <http://www.ti.com/productcontent> for the latest availability information and additional product content details.

TBD: The Pb-Free/Green conversion plan has not been defined.

Pb-Free (RoHS): TI's terms "Lead-Free" or "Pb-Free" mean semiconductor products that are compatible with the current RoHS requirements for all 6 substances, including the requirement that lead not exceed 0.1% by weight in homogeneous materials. Where designed to be soldered at high temperatures, TI Pb-Free products are suitable for use in specified lead-free processes.

Pb-Free (RoHS Exempt): This component has a RoHS exemption for either 1) lead-based flip-chip solder bumps used between the die and package, or 2) lead-based die adhesive used between the die and leadframe. The component is otherwise considered Pb-Free (RoHS compatible) as defined above.

Green (RoHS & no Sb/Br): TI defines "Green" to mean Pb-Free (RoHS compatible), and free of Bromine (Br) and Antimony (Sb) based flame retardants (Br or Sb do not exceed 0.1% by weight in homogeneous material)

(3) MSL, Peak Temp. -- The Moisture Sensitivity Level rating according to the JEDEC industry standard classifications, and peak solder temperature.

(4) There may be additional marking, which relates to the logo, the lot trace code information, or the environmental category on the device.

(5) Multiple Device Markings will be inside parentheses. Only one Device Marking contained in parentheses and separated by a "~" will appear on a device. If a line is indented then it is a continuation of the previous line and the two combined represent the entire Device Marking for that device.

Important Information and Disclaimer: The information provided on this page represents TI's knowledge and belief as of the date that it is provided. TI bases its knowledge and belief on information provided by third parties, and makes no representation or warranty as to the accuracy of such information. Efforts are underway to better integrate information from third parties. TI has taken and continues to take reasonable steps to provide representative and accurate information but may not have conducted destructive testing or chemical analysis on incoming materials and chemicals. TI and TI suppliers consider certain information to be proprietary, and thus CAS numbers and other limited information may not be available for release.

In no event shall TI's liability arising out of such information exceed the total purchase price of the TI part(s) at issue in this document sold by TI to Customer on an annual basis.

OTHER QUALIFIED VERSIONS OF TPS71709-Q1, TPS71750-Q1 :

- Catalog: [TPS71709](#), [TPS71750](#)

NOTE: Qualified Version Definitions:

- Catalog - TI's standard catalog product

TAPE AND REEL INFORMATION



QUADRANT ASSIGNMENTS FOR PIN 1 ORIENTATION IN TAPE



*All dimensions are nominal

Device	Package Type	Package Drawing	Pins	SPQ	Reel Diameter (mm)	Reel Width W1 (mm)	A0 (mm)	B0 (mm)	K0 (mm)	P1 (mm)	W (mm)	Pin1 Quadrant
TPS71709QDSERQ1	WSON	DSE	6	3000	179.0	8.4	1.8	1.8	1.0	4.0	8.0	Q2
TPS71750QDSERQ1	WSON	DSE	6	3000	179.0	8.4	1.8	1.8	1.0	4.0	8.0	Q2

TAPE AND REEL BOX DIMENSIONS

*All dimensions are nominal

Device	Package Type	Package Drawing	Pins	SPQ	Length (mm)	Width (mm)	Height (mm)
TPS71709QDSERQ1	WSON	DSE	6	3000	203.0	203.0	35.0
TPS71750QDSERQ1	WSON	DSE	6	3000	203.0	203.0	35.0

DSE (S-PDSO-N6)

PLASTIC SMALL OUTLINE

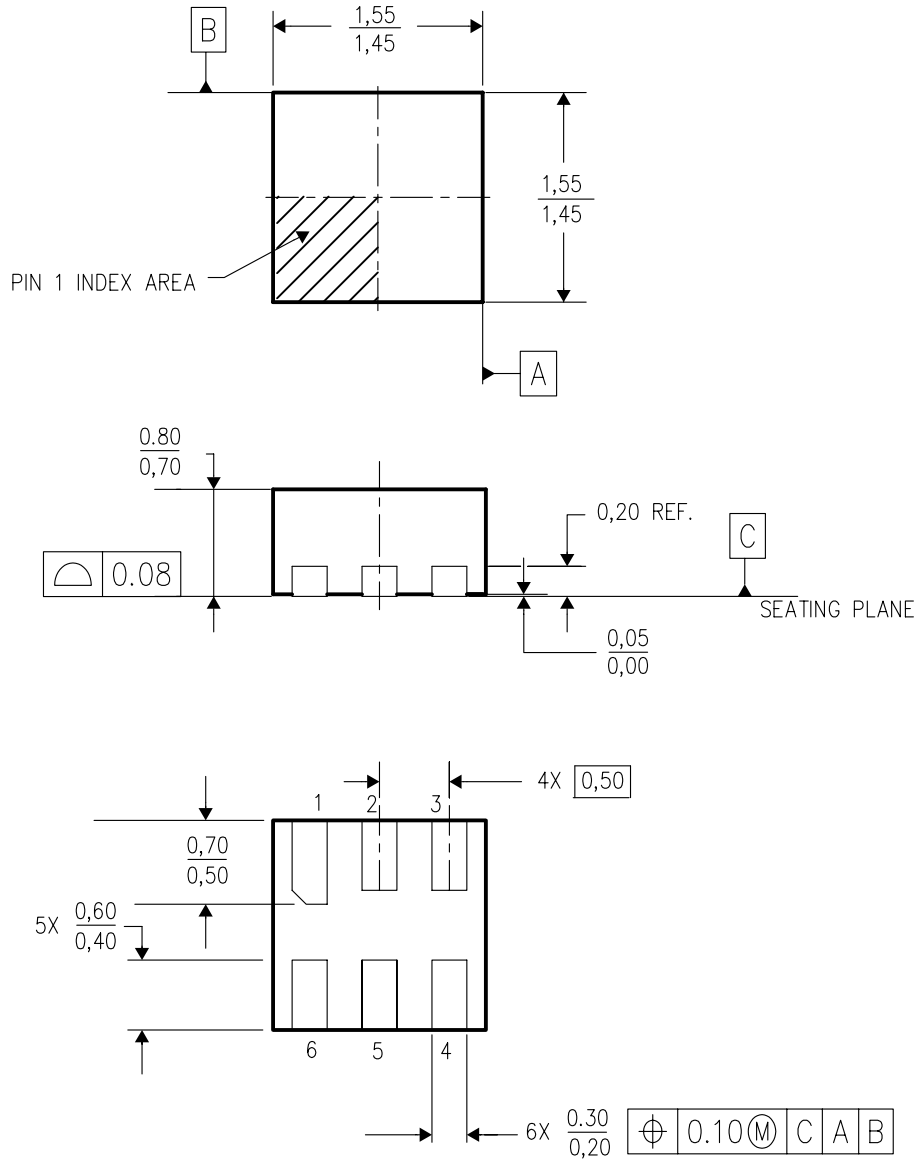

4207810/A 03/06

- NOTES:
- A. All linear dimensions are in millimeters.
 - B. This drawing is subject to change without notice.
 - C. Small Outline No-Lead (SON) package configuration.
 - D. This package is lead-free.

IMPORTANT NOTICE

Texas Instruments Incorporated and its subsidiaries (TI) reserve the right to make corrections, enhancements, improvements and other changes to its semiconductor products and services per JESD46, latest issue, and to discontinue any product or service per JESD48, latest issue. Buyers should obtain the latest relevant information before placing orders and should verify that such information is current and complete. All semiconductor products (also referred to herein as "components") are sold subject to TI's terms and conditions of sale supplied at the time of order acknowledgment.

TI warrants performance of its components to the specifications applicable at the time of sale, in accordance with the warranty in TI's terms and conditions of sale of semiconductor products. Testing and other quality control techniques are used to the extent TI deems necessary to support this warranty. Except where mandated by applicable law, testing of all parameters of each component is not necessarily performed.

TI assumes no liability for applications assistance or the design of Buyers' products. Buyers are responsible for their products and applications using TI components. To minimize the risks associated with Buyers' products and applications, Buyers should provide adequate design and operating safeguards.

TI does not warrant or represent that any license, either express or implied, is granted under any patent right, copyright, mask work right, or other intellectual property right relating to any combination, machine, or process in which TI components or services are used. Information published by TI regarding third-party products or services does not constitute a license to use such products or services or a warranty or endorsement thereof. Use of such information may require a license from a third party under the patents or other intellectual property of the third party, or a license from TI under the patents or other intellectual property of TI.

Reproduction of significant portions of TI information in TI data books or data sheets is permissible only if reproduction is without alteration and is accompanied by all associated warranties, conditions, limitations, and notices. TI is not responsible or liable for such altered documentation. Information of third parties may be subject to additional restrictions.

Resale of TI components or services with statements different from or beyond the parameters stated by TI for that component or service voids all express and any implied warranties for the associated TI component or service and is an unfair and deceptive business practice. TI is not responsible or liable for any such statements.

Buyer acknowledges and agrees that it is solely responsible for compliance with all legal, regulatory and safety-related requirements concerning its products, and any use of TI components in its applications, notwithstanding any applications-related information or support that may be provided by TI. Buyer represents and agrees that it has all the necessary expertise to create and implement safeguards which anticipate dangerous consequences of failures, monitor failures and their consequences, lessen the likelihood of failures that might cause harm and take appropriate remedial actions. Buyer will fully indemnify TI and its representatives against any damages arising out of the use of any TI components in safety-critical applications.

In some cases, TI components may be promoted specifically to facilitate safety-related applications. With such components, TI's goal is to help enable customers to design and create their own end-product solutions that meet applicable functional safety standards and requirements. Nonetheless, such components are subject to these terms.

No TI components are authorized for use in FDA Class III (or similar life-critical medical equipment) unless authorized officers of the parties have executed a special agreement specifically governing such use.

Only those TI components which TI has specifically designated as military grade or "enhanced plastic" are designed and intended for use in military/aerospace applications or environments. Buyer acknowledges and agrees that any military or aerospace use of TI components which have **not** been so designated is solely at the Buyer's risk, and that Buyer is solely responsible for compliance with all legal and regulatory requirements in connection with such use.

TI has specifically designated certain components as meeting ISO/TS16949 requirements, mainly for automotive use. In any case of use of non-designated products, TI will not be responsible for any failure to meet ISO/TS16949.

Products

Audio	www.ti.com/audio
Amplifiers	amplifier.ti.com
Data Converters	dataconverter.ti.com
DLP® Products	www.dlp.com
DSP	dsp.ti.com
Clocks and Timers	www.ti.com/clocks
Interface	interface.ti.com
Logic	logic.ti.com
Power Mgmt	power.ti.com
Microcontrollers	microcontroller.ti.com
RFID	www.ti-rfid.com
OMAP Applications Processors	www.ti.com/omap
Wireless Connectivity	www.ti.com/wirelessconnectivity

Applications

Automotive and Transportation	www.ti.com/automotive
Communications and Telecom	www.ti.com/communications
Computers and Peripherals	www.ti.com/computers
Consumer Electronics	www.ti.com/consumer-apps
Energy and Lighting	www.ti.com/energy
Industrial	www.ti.com/industrial
Medical	www.ti.com/medical
Security	www.ti.com/security
Space, Avionics and Defense	www.ti.com/space-avionics-defense
Video and Imaging	www.ti.com/video

TI E2E Community

e2e.ti.com