

CoolMOS™ Power Transistor
Features

- Lowest figure-of-merit $R_{ON} \times Q_g$
- Ultra low gate charge
- Extreme dv/dt rated
- High peak current capability
- Qualified according to JEDEC⁽¹⁾ for target applications
- Pb-free lead plating; RoHS compliant

Product Summary

V_{DS}	600	V
$R_{DS(on),max}$	0.299	Ω
$Q_{g,typ}$	22	nC

CoolMOS CP is specially designed for:

Hard switching SMPS topologies

PG-TO220-3-1

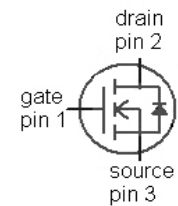
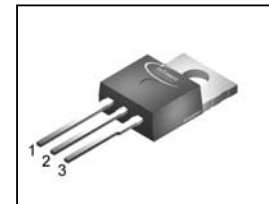

Type	Package	Ordering Code	Marking
IPP60R299CP	PG-TO220-3-1	SP000084280	6R299P

Maximum ratings, at $T_j=25\text{ °C}$, unless otherwise specified

Parameter	Symbol	Conditions	Value	Unit
Continuous drain current	I_D	$T_C=25\text{ °C}$	11	A
		$T_C=100\text{ °C}$	7	
Pulsed drain current ⁽²⁾	$I_{D,pulse}$	$T_C=25\text{ °C}$	34	
Avalanche energy, single pulse	E_{AS}	$I_D=4.4\text{ A}$, $V_{DD}=50\text{ V}$	290	mJ
Avalanche energy, repetitive t_{AR} ^(2),3)	E_{AR}	$I_D=4.4\text{ A}$, $V_{DD}=50\text{ V}$	0.44	
Avalanche current, repetitive t_{AR} ^(2),3)	I_{AR}		4.4	A
MOSFET dv/dt ruggedness	dv/dt	$V_{DS}=0\dots480\text{ V}$	50	V/ns
Gate source voltage	V_{GS}	static	± 20	V
		AC ($f > 1\text{ Hz}$)	± 30	
Power dissipation	P_{tot}	$T_C=25\text{ °C}$	96	W
Operating and storage temperature	T_j , T_{stg}		-55 ... 150	$^{\circ}\text{C}$
Mounting torque		M3 and M3.5 screws	60	Ncm

Maximum ratings, at $T_j=25\text{ }^\circ\text{C}$, unless otherwise specified

Parameter	Symbol	Conditions	Value	Unit
Continuous diode forward current	I_S	$T_C=25\text{ }^\circ\text{C}$	6.6	A
Diode pulse current	$I_{S,pulse}$		34	
Reverse diode dv/dt	dv/dt		tbd	V/ns
Maximum diode commutation speed	di/dt		tbd	A/ μs

Parameter	Symbol	Conditions	Values			Unit
			min.	typ.	max.	

Thermal characteristics

Thermal resistance, junction - case	R_{thJC}		-	-	1.3	K/W
Thermal resistance, junction - ambient	R_{thJA}	leaded	-	-	62	
Soldering temperature, wavesoldering	T_{sold}	1.6 mm (0.063 in.) from case for 10 s	-	-	260	$^\circ\text{C}$

Electrical characteristics, at $T_j=25\text{ }^\circ\text{C}$, unless otherwise specified
Static characteristics

Drain-source breakdown voltage	$V_{(BR)DSS}$	$V_{GS}=0\text{ V}, I_D=250\text{ }\mu\text{A}$	600	-	-	V
Gate threshold voltage	$V_{GS(th)}$	$V_{DS}=V_{GS}, I_D=0.44\text{ mA}$	2.5	3	3.5	
Zero gate voltage drain current	I_{DSS}	$V_{DS}=600\text{ V}, V_{GS}=0\text{ V}, T_j=25\text{ }^\circ\text{C}$	-	-	1	μA
		$V_{DS}=600\text{ V}, V_{GS}=0\text{ V}, T_j=150\text{ }^\circ\text{C}$	-	tbd	-	
Gate-source leakage current	I_{GSS}	$V_{GS}=20\text{ V}, V_{DS}=0\text{ V}$	-	-	100	nA
Drain-source on-state resistance	$R_{DS(on)}$	$V_{GS}=10\text{ V}, I_D=6.6\text{ A}, T_j=25\text{ }^\circ\text{C}$	-	0.27	0.299	Ω
		$V_{GS}=10\text{ V}, I_D=6.6\text{ A}, T_j=150\text{ }^\circ\text{C}$	-	0.73		
Gate resistance	R_G	$f=1\text{ MHz}$, open drain	-	tbd	-	Ω

Parameter	Symbol	Conditions	Values			Unit
			min.	typ.	max.	

Dynamic characteristics

Input capacitance	C_{iss}	$V_{GS}=0\text{ V}, V_{DS}=100\text{ V},$ $f=1\text{ MHz}$	-	1100	-	pF
Output capacitance	C_{oss}		-	60	-	
Effective output capacitance, energy related ⁴⁾	$C_{o(er)}$	$V_{GS}=0\text{ V}, V_{DS}=0\text{ V}$ to 480 V	-	46	-	
Effective output capacitance, time related ⁵⁾	$C_{o(tr)}$		-	120	-	
Turn-on delay time	$t_{d(on)}$	$V_{DD}=400\text{ V},$ $V_{GS}=10\text{ V}, I_D=6,6\text{ A},$ $R_G=4,3\ \Omega$	-	tbd	-	ns
Rise time	t_r		-	tbd	-	
Turn-off delay time	$t_{d(off)}$		-	tbd	-	
Fall time	t_f		-	tbd	-	

Gate Charge Characteristics

Gate to source charge	Q_{gs}	$V_{DD}=400\text{ V}, I_D=6.6\text{ A},$ $V_{GS}=0\text{ to }10\text{ V}$	-	5	-	nC
Gate to drain charge	Q_{gd}		-	7.6	-	
Gate charge total	Q_g		-	22	29	
Gate plateau voltage	$V_{plateau}$		-	5.0	-	V

Reverse Diode

Diode forward voltage	V_{SD}	$V_{GS}=0\text{ V}, I_F=6.6\text{ A},$ $T_j=25\text{ }^\circ\text{C}$	-	0.9	1.2	V
Reverse recovery time	t_{rr}	$V_R=400\text{ V}, I_F=I_S,$ $di_F/dt=100\text{ A}/\mu\text{s}$	-	300	-	ns
Reverse recovery charge	Q_{rr}		-	3.9	-	μC
Peak reverse recovery current	I_{rrm}		-	26	-	A

¹⁾ J-STD20 and JESD22

²⁾ Pulse width t_p limited by $T_{j,max}$

³⁾ Repetitive avalanche causes additional power losses that can be calculated as $P_{AV}=E_{AR} \cdot f$.

⁴⁾ $C_{o(er)}$ is a fixed capacitance that gives the same stored energy as C_{oss} while V_{DS} is rising from 0 to 80% V_{DSS} .

⁵⁾ $C_{o(tr)}$ is a fixed capacitance that gives the same charging time as C_{oss} while V_{DS} is rising from 0 to 80% V_{DSS} .

1 Power dissipation

$P_{tot}=f(T_C)$

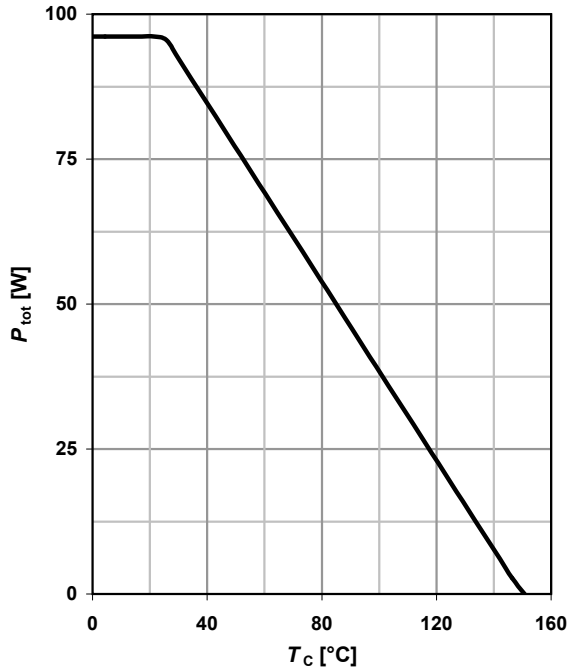

2 Safe operating area

$I_D=f(V_{DS}); T_C=25\text{ °C}; D=0$

parameter: t_p

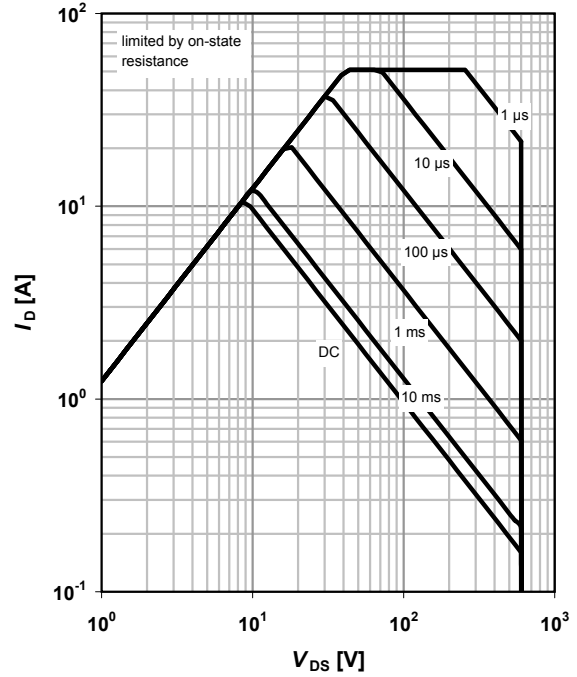

3 Max. transient thermal impedance

$Z_{thJC}=f(t_p)$

parameter: $D=t_p/T$

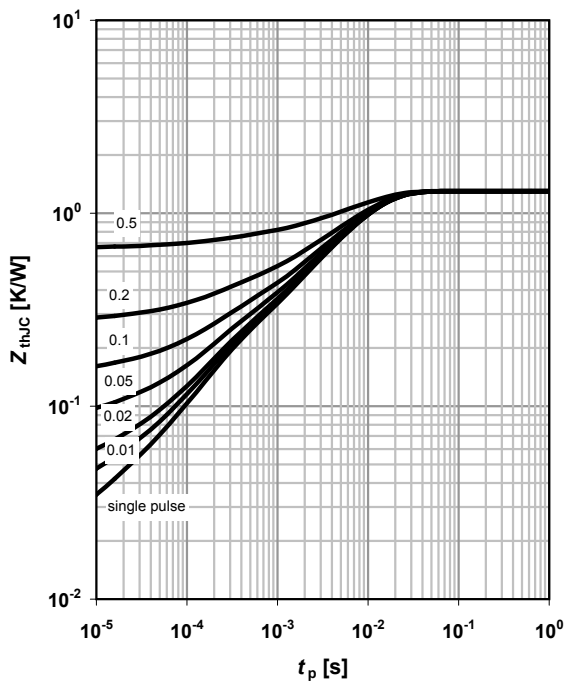

4 Typ. output characteristics

$I_D=f(V_{DS}); T_j=25\text{ °C}$

parameter: V_{GS}

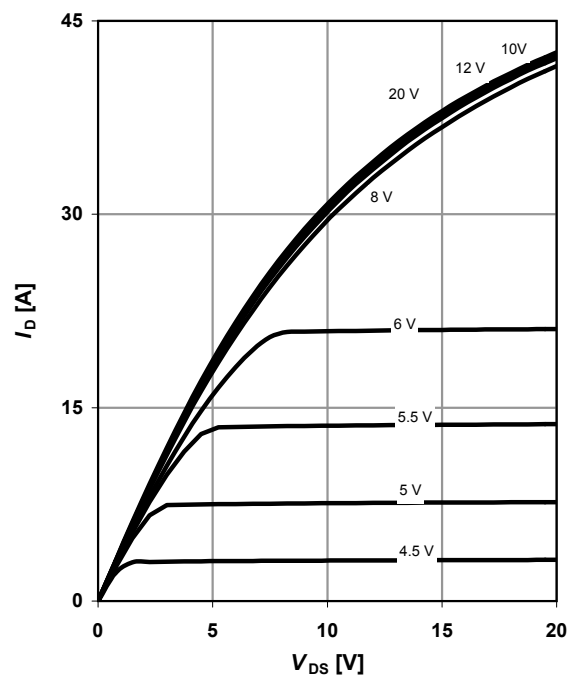

5 Typ. output characteristics

$I_D = f(V_{DS}); T_j = 150\text{ }^\circ\text{C}$

parameter: V_{GS}

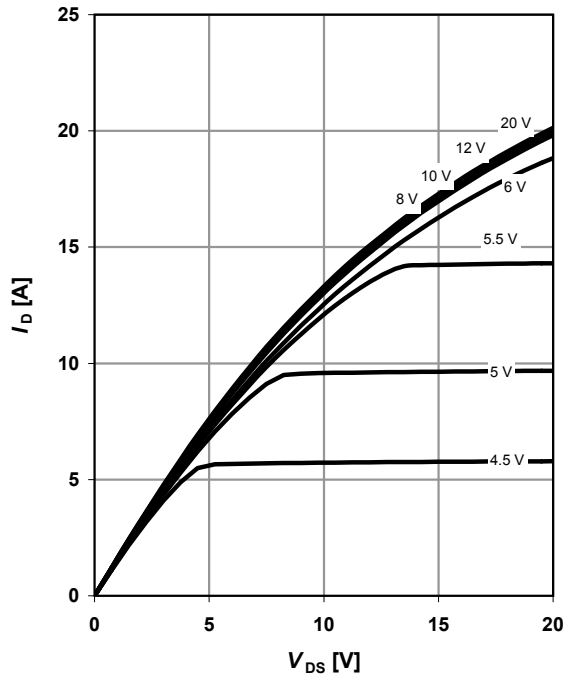

6 Typ. drain-source on-state resistance

$R_{DS(on)} = f(I_D); T_j = 150\text{ }^\circ\text{C}$

parameter: V_{GS}

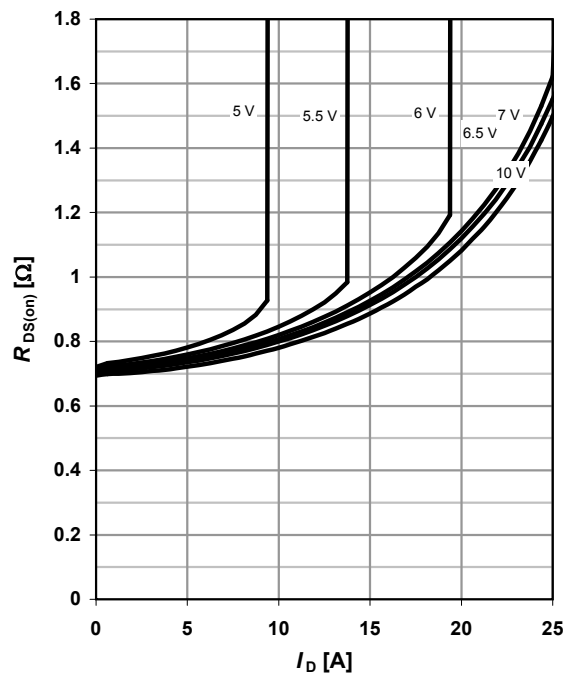

7 Drain-source on-state resistance

$R_{DS(on)} = f(T_j); I_D = 6.6\text{ A}; V_{GS} = 10\text{ V}$

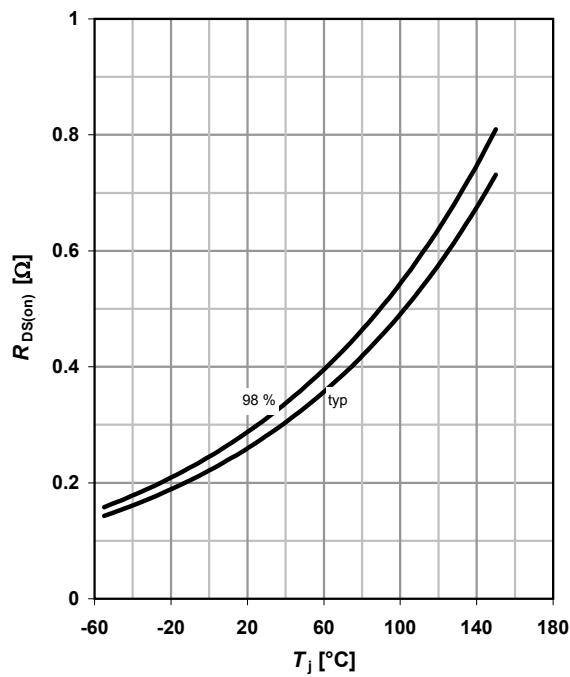

8 Typ. transfer characteristics

$I_D = f(V_{GS}); |V_{DS}| > 2 I_D / R_{DS(on)max}$

parameter: T_j

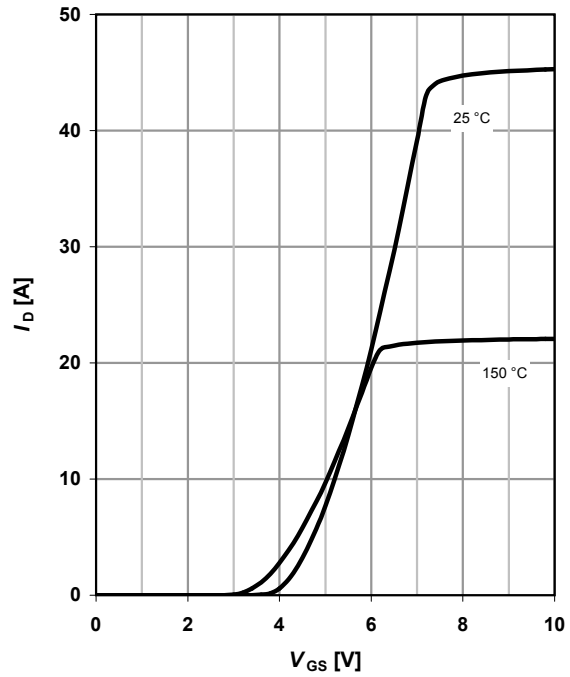

9 Typ. gate charge

$V_{GS}=f(Q_{gate}); I_D=6.6 \text{ A pulsed}$

parameter: V_{DD}

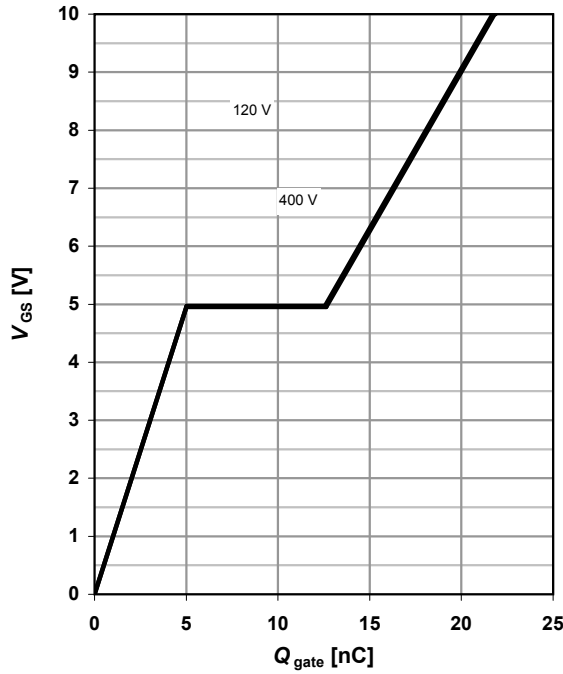

10 Forward characteristics of reverse diode

$I_F=f(V_{SD})$

parameter: T_j

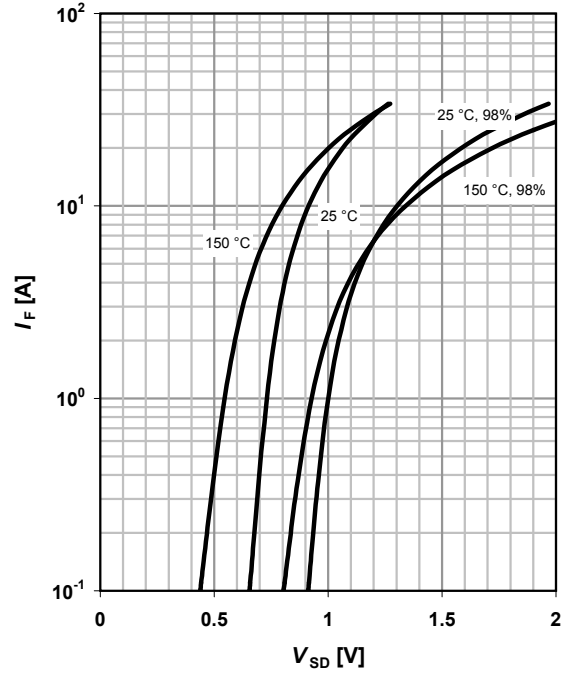

11 Avalanche energy

$E_{AS}=f(T_j); I_D=4.4 \text{ A}; V_{DD}=50 \text{ V}$

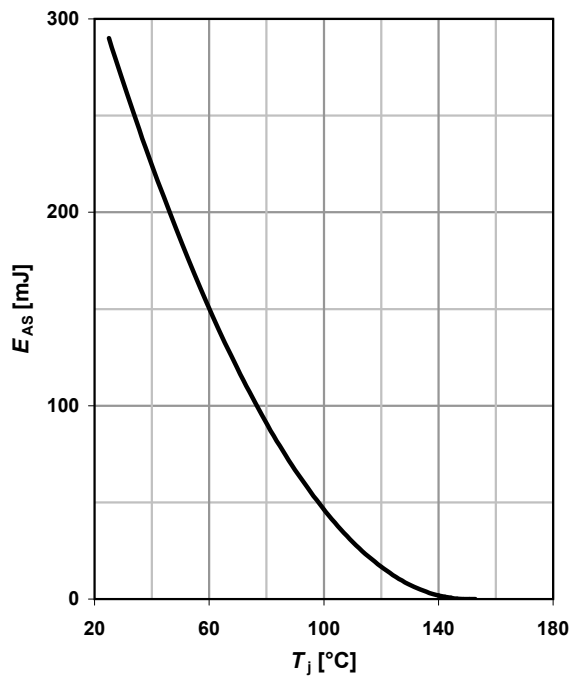

12 Drain-source breakdown voltage

$V_{BR(DSS)}=f(T_j); I_D=0.25 \text{ mA}$

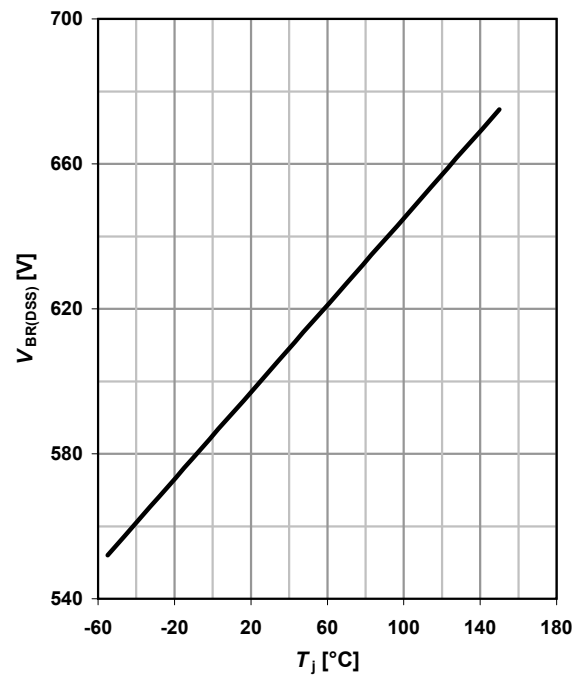

13 Typ. capacitances

$C=f(V_{DS}); V_{GS}=0\text{ V}; f=1\text{ MHz}$

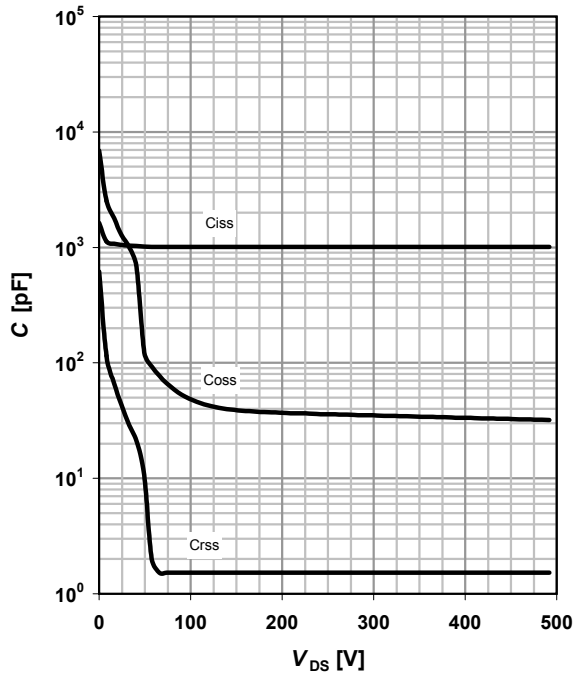

14 Typ. Coss stored energy

$E_{oss}=f(V_{DS})$

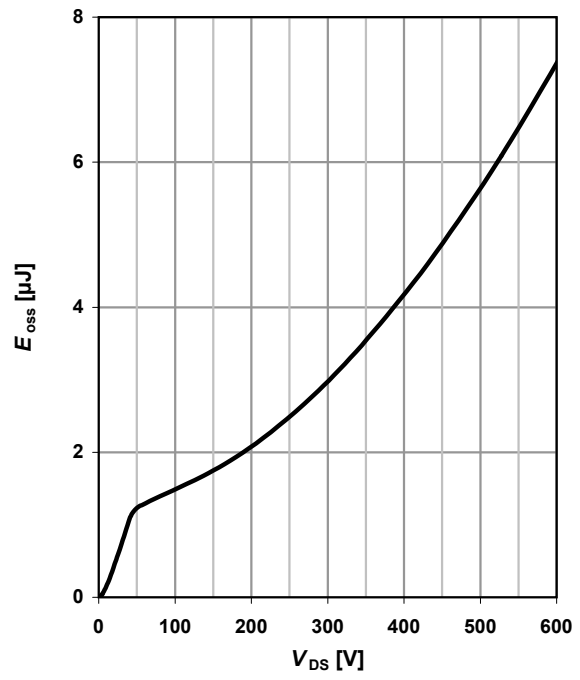

Definition of diode switching characteristics

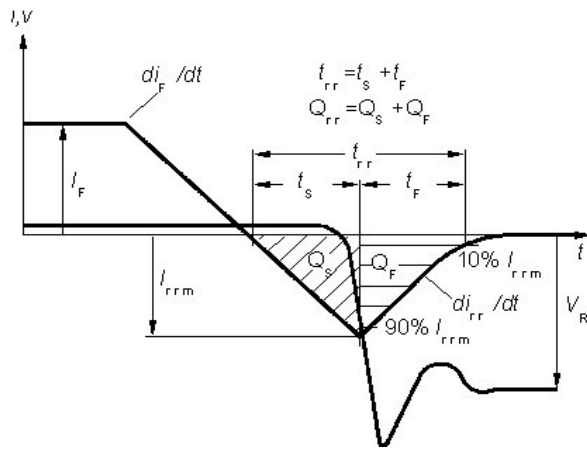

PG-TO220-3-1: Outline

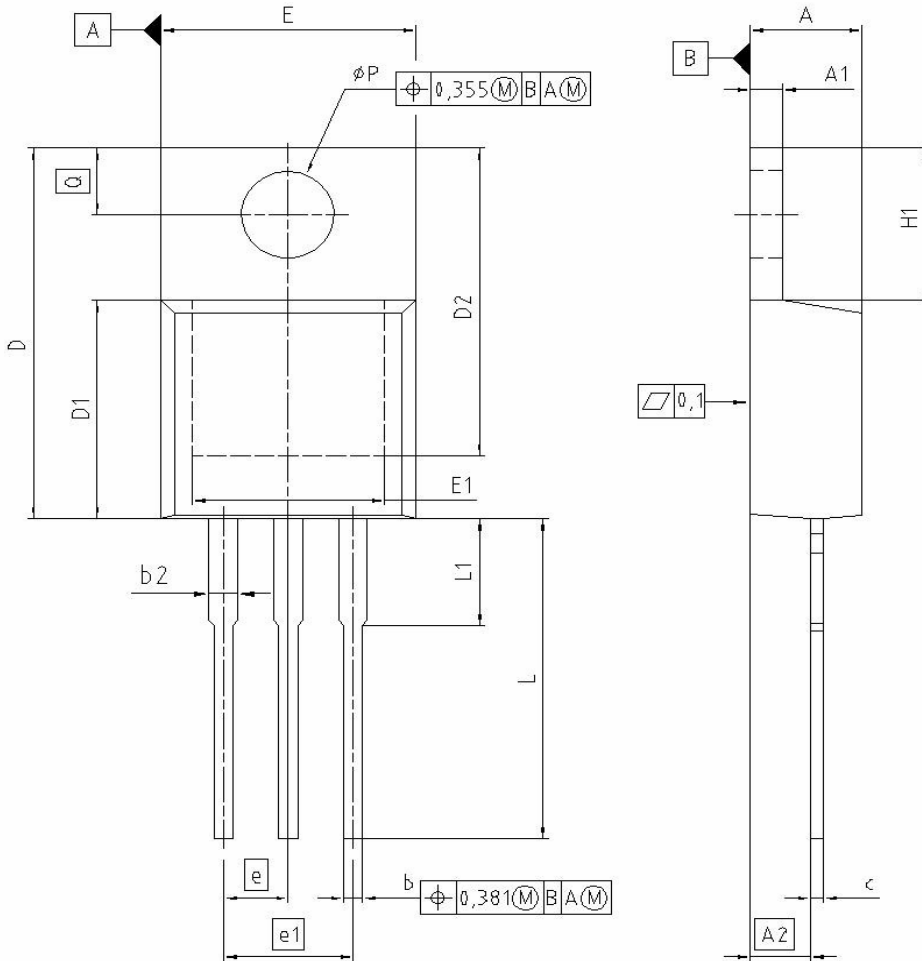

DIM	MILLIMETERS		INCHES	
	MIN	MAX	MIN	MAX
A	4.300	4.572	0.169	0.180
A1	1.170	1.400	0.046	0.055
A2	2.215	2.718	0.087	0.107
b	0.650	0.864	0.026	0.034
b2	0.635	1.778	0.025	0.070
c	0.330	0.600	0.013	0.024
D	14.808	15.950	0.583	0.628
D1	8.509	9.450	0.335	0.372
D2	12.850	13.100	0.506	0.516
E	9.700	10.363	0.382	0.408
E1	6.500	8.600	0.256	0.339
e	2.540		0.100	
e1	5.080		0.200	
N	3		3	
H1	5.900	6.900	0.232	0.272
L	13.000	14.000	0.512	0.551
L1	-	4.800	-	0.189
phi P	3.700	3.886	0.146	0.153
Q	2.600	3.000	0.102	0.118

REFERENCE
JEDEC TO220

SCALE

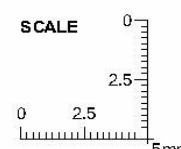

EUROPEAN PROJECTION

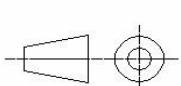

ISSUE DATE
01-06-2005

FILE
TO220_1

Dimensions in mm/inches

Published by
Infineon Technologies AG
Bereich Kommunikation
St.-Martin-Straße 53
D-81541 München
© Infineon Technologies AG 1999
All Rights Reserved.

Attention please!

The information herein is given to describe certain components and shall not be considered as warranted characteristics.

Terms of delivery and rights to technical change reserved.

We hereby disclaim any and all warranties, including but not limited to warranties of non-infringement, regarding circuits, descriptions and charts stated herein.

Infineon Technologies is an approved CECC manufacturer.

Information

For further information on technology, delivery terms and conditions and prices, please contact your nearest Infineon Technologies office in Germany or our Infineon Technologies representatives worldwide (see address list).

Warnings

Due to technical requirements, components may contain dangerous substances.

For information on the types in question, please contact your nearest Infineon Technologies office.

Infineon Technologies' components may only be used in life-support devices or systems with the expressed written approval of Infineon Technologies if a failure of such components can reasonably be expected to cause the failure of that life-support device or system, or to affect the safety or effectiveness of that device or system. Life support devices or systems are intended to be implanted in the human body, or to support and/or maintain and sustain and/or protect human life. If they fail, it is reasonable to assume that the health of the user or other persons may be endangered.